

48783

VIDEOCIPHER CRACKED!

See Page 4

\$1.95 JAN. 87
IN CANADA \$2.50

Radio — Electronics®

TECHNOLOGY - VIDEO - STEREO - COMPUTERS - SERVICE

BUILD THIS STEREO-TV DECODER

Stereo sound
from any TV!

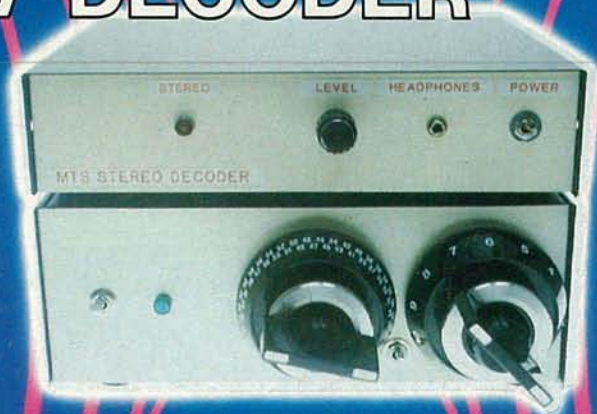

GERNSBACK
PUBLICATION

BUILD THE R-E ROBOT

A personal
robot you
can customize

DESCRAMBLING

Gated-sync and
outband systems

HOW TO GET A PATENT

Protect your inventions

BUILD AN INTERCOM SYSTEM

For home or small office

PLUS:

- ★ Audio Update
- ★ Video News
- ★ New Products
- ★ Antique Radios
- ★ Satellite TV
- ★ Service Clinic
- ★ **COMPUTERDIGEST**



NOW GET SCOPE, COUNTER AND DMM INPUT ALL AT ONCE THROUGH ONE PROBE!

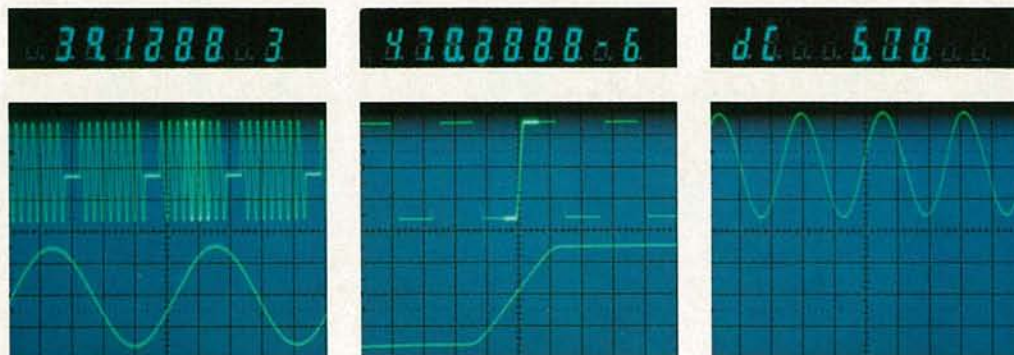

Gated frequency measurement. B sweep triggering during the intensified portion of the A sweep. Intensified portion frequency is measured with the counter/timer/DMM.

Delay time measurement. Delay time from the start of A sweep to the start of the B sweep is measured with *crystal accuracy*.

Channel 1 dc volts measurement. The average dc component of a waveform is measured directly through channel 1 with direct digital fluorescent readout.

The Tek 2236 combines 100 MHz, dual timebase scope capability with counter/timer/DMM functions integrated into its vertical, horizontal and trigger systems. For the same effort it takes to display a waveform you can obtain digital readout of frequency, period, width, totalized events, delay time and Δ -time to accuracies of 0.001%.

The same probe is used to provide input for the CRT display and the digital measurement system, resulting in easy set-up, greater measurement confidence and reduced circuit loading. Probe tip volts can also be measured through the Ch 1 input.

Precision measurements at the touch of a button.

Auto-ranging frequency, period, width and gated measurements are push-button-simple. And the 2236 offers an independent floating 5000 count, auto-ranging multimeter with side inputs for DC voltage mea-



Bandwidth	100 MHz
No of Channels	2 + Trig. View
Max. Sweep Speed	5 ns/div
Digital Readout Features	Direct Ch 1 Voltage Meas. 0.5% DC; 2.0% AC RMS Resistance: .01 Ω to 200 Meg Ω Continuity/Temp: Audible/C $^{\circ}$ or F $^{\circ}$ Totalizing Counter: — 1 counts to 8,000,000 Direct Freq. Meas: 100 MHz to 0.001% acc. Period, Width Meas: 10 ns with 10 ps max. resolution
Timing Meas. Accuracy	.001% (delay and Δ -time with readout)
Trigger Modes	P-P Auto, Norm, TV Field, TV Line, Single Sweep
Weight	7.3 kg (16.2 lb)
Price	\$2650
Warranty	3-year including CRT (plus optional service plans to 5 years)

surements to 0.1%.

A built-in, auto-ranging ohmmeter provides resistance measurements from 0.01 Ω to 2G Ω —as well as audible continuity. Automatic diode/junction detection and operator prompts serve to simplify set-up and enhance confidence in your measurements.

The 2236: scope, counter, timer, DMM plus a 3-year warranty —all for just \$2,650.

Contact your nearest distributor or call Tek toll-free. Technical personnel on our direct-line will answer your questions and expedite delivery. Orders include probes, 30-day free trial and service worldwide.

Call Tek direct:

1-800-433-2323 for video tape or literature,

1-800-426-2200 for application assistance or ordering information.

In Oregon, call collect: **1-627-2200**

Tektronix
COMMITTED TO EXCELLENCE

JANUARY '87

**Radio-
Electronics**

Electronics publishers since 1908

Vol. 58 No. 1

- BUILD THIS**
- 37 **STEREO TV DECODER**
Double your TV listening pleasure.
Tod T. Templin
 - 42 **R-E ROBOT**
Part 2. A look at the robot's control computer.
Steven E. Sarns
 - 57 **NINE-STATION INTERCOM**
It's perfect for home or small office. **Dwight Morrison**
 - 67 **PC SERVICE**
Use the direct-etch foil patterns to make circuit boards for your intercom system.

- TECHNOLOGY**
- 4 **SATELLITE TV** Videocipher has been busted!
Bob Cooper, Jr.
 - 16 **VIDEO NEWS**
A review of the fast-changing video scene. **David Lachenbruch**
 - 48 **HOW TO APPLY FOR A PATENT**
Learn how to protect your latest inventions. You really can do it yourself! **Dave Sweeney**
 - 61 **WHAT'S NEW IN SOLID STATE**
The latest happenings in solid-state technology. **Robert F. Scott**
 - 72 **AUDIO UPDATE**
Our new column! Audio signal processors. **Larry Klein**
 - 89 **SERVICE CLINIC**
Leaking capacitors. **Jack Darr**
 - 90 **SERVICE QUESTIONS**
Our service editor answers readers' questions.

- CIRCUITS AND COMPONENTS**
- 53 **TV SIGNAL DESCRAMBLING**
Part 7. How to build and align a gated-pulse decoder.
Rudolf F. Graf and William Sheets.
 - 65 **HOW TO DESIGN OSCILLATOR CIRCUITS**
Part 7. The concluding installment looks at CMOS oscillators.
Joseph J. Carr
 - 82 **DRAWING BOARD**
A remote-control system. **Robert Grossblatt**

RADIO

- 74 **ANTIQUÉ RADIOS**
A history of the portable radio.
Richard D. Fitch
- 86 **COMMUNICATIONS CORNER**
The tunable IF amplifier gives high process performance to moderately priced communication equipment. **Herb Friedman**

COMPUTERS

- Following page 78
- COMPUTER DIGEST**
Using your computer to aim your satellite-TV antenna; 5-volt RS-232; All about computer interfacing; How to let your computer figure out the frequency of your favorite TV channels, and more!

EQUIPMENT REPORTS

- 22 **Pencept Penpad 320**
Digitizing Tablet
- 71 **Beckman Industrial DM-800**
DMM

DEPARTMENTS

- 112 Advertising and Sales Offices
- 112 Advertising Index
- 113 Free Information Card
- 12 Editorial
- 18 Letters
- 92 Market Center
- 30 New Products
- 14 What's News

RADIO-ELECTRONICS, (ISSN 0033-7862) January 1987. Published monthly by Gernsback Publications, Inc., 500-B Bi-County Boulevard, Farmingdale, NY 11735 Second-Class Postage paid at Farmingdale, NY and additional mailing offices. Second-Class mail registration No. 9242 authorized at Toronto, Canada. One-year subscription rate U.S.A. and possessions \$16.97. Canada \$22.97; all other countries \$25.97. Subscription orders payable in US funds only, international postal money order or check drawn on a U.S.A. bank. Single copies \$1.95. © 1986 by Gernsback Publications, Inc. All rights reserved. Printed in U.S.A.

POSTMASTER: Please send address changes to RADIO-ELECTRONICS, Subscription Dept., Box 55115, Boulder, CO 80321-5115.

A stamped self-addressed envelope must accompany all submitted manuscripts and/or artwork or photographs if their return is desired should they be rejected. We disclaim any responsibility for the loss or damage of manuscripts and/or artwork or photographs while in our possession or otherwise.

COVER 1



Ever since we published our first stereo decoder in March of 1986, we've received many requests for a unit that works better and includes dbx noise reduction. Well the decoder we've come up with doesn't include true dbx noise reduction, but it comes perhaps as close as possible! If you've been looking for a way to double your TV listening pleasure, then this is it. The decoder is easy to build and align, and it can work with any TV. We even show you how to use it without making a direct connection to your TV! For more details, turn to page 37.

NEXT MONTH

THE FEBRUARY ISSUE IS
ON SALE JANUARY 6

CABLE TV DESCRAMBLING

Our coverage of this important topic continues.

BUILD A VERSATILE UNIVERSAL TIMER

Turn any appliance on and off up to three pre-set times per day.

BUILD THE R-E ROBOT

Designing and building the robot base.

TESTING SEMICONDUCTORS

Our new back-to-school series begins.

As a service to readers, RADIO-ELECTRONICS publishes available plans or information relating to newsworthy products, techniques and scientific and technological developments. Because of possible variances in the quality and condition of materials and workmanship used by readers, RADIO-ELECTRONICS disclaims any responsibility for the safe and proper functioning of reader-built projects based upon or from plans or information published in this magazine.

Since some of the equipment and circuitry described in RADIO-ELECTRONICS may relate to or be covered by U.S. patents, RADIO-ELECTRONICS disclaims any liability for the infringement of such patents by the making, using, or selling of any such equipment or circuitry, and suggests that anyone interested in such projects consult a patent attorney.

Radio Electronics

Hugo Gernsback (1884-1967) founder
M. Harvey Gernsback,
editor-in-chief, emeritus

Larry Steckler, EHF, CET, editor-in-chief
and publisher

EDITORIAL DEPARTMENT

Art Kleiman, editorial director
Brian C. Fenton, managing editor
Carl Laron, WB2SLR, associate editor
Jeffrey K. Holtzman,
assistant technical editor
Robert A. Young, assistant editor
Julian S. Martin, editorial associate
Byron G. Wels, editorial associate
M. Harvey Gernsback,
contributing editor
Jack Darr, CET, service editor
Robert F. Scott,
semiconductor editor
Herb Friedman,
communications editor
Bob Cooper, Jr. satellite-TV editor
Robert Grossblatt, circuits editor
Larry Klein, audio editor
David Lachenbruch,
contributing editor
Richard D. Fitch,
contributing editor
Mark J. Robillard, robotics editor
Teri Scaduto, editorial assistant

PRODUCTION DEPARTMENT

Ruby M. Yee, production director
Robert A. W. Lowndes,
editorial production
Andre Duzant, technical illustrator
Karen Tucker, advertising production
Geoffrey S. Weil, production traffic

CIRCULATION DEPARTMENT

Jacqueline P. Cheeseboro,
circulation director
Wendy Alanko,
circulation analyst
Theresa Lombardo,
circulation assistant

Cover photo by Dan Muro

Typography by Mates Graphics

Radio-Electronics, Gernsback Publica-
tions, Inc., 500-B Bi-County Blvd.,
Farmingdale, NY 11735.
516-293-3000

Radio-Electronics is indexed in
Applied Science & Technology Index
and *Readers Guide to Periodical Liter-
ature*.

Microfilm & Microfiche editions are
available. Contact circulation depart-
ment for details.

Advertising Sales Offices listed
on page 112.



NEW! Lower Price Scanners

Communications Electronics™, the world's largest distributor of radio scanners, introduces new lower prices to celebrate our 15th anniversary.

Regency® MX7000-GR

List price \$699.95/CE price \$469.95
10-Band, 20 Channel • Crystalless • AC/DC
Frequency range: 25-550 MHz, continuous coverage and 800 MHz to 1.3 GHz, continuous coverage. The Regency MX7000 scanner lets you monitor Military, Space Satellites, Government, Railroad, Justice Department, State Department, Fish & Game, Immigration, Marine, Police and Fire Departments, Broadcast Studio Transmitter Links, Aeronautical AM band, Aero Navigation, Paramedics, Amateur Radio, plus thousands of other radio frequencies most scanners can't pick up. The Regency MX7000 is the perfect scanner to receive the exciting 1.2 GHz. amateur radio band.

Regency® Z60-GR

List price \$299.95/CE price \$179.95/SPECIAL
8-Band, 60 Channel • No-crystal scanner
Bands: 30-50, 88-108, 118-136, 144-174, 440-512 MHz. The Regency Z60 covers all the public service bands plus aircraft and FM music for a total of eight bands. The Z60 also features an alarm clock and priority control as well as AC/DC operation. Order today.

Regency® Z45-GR

List price \$259.95/CE price \$159.95/SPECIAL
7-Band, 45 Channel • No-crystal scanner
Bands: 30-50, 118-136, 144-174, 440-512 MHz. The Regency Z45 is very similar to the Z60 model listed above however it does not have the commercial FM broadcast band. The Z45, now at a special price from Communications Electronics.

Regency® RH250B-GR

List price \$659.00/CE price \$329.95/SPECIAL
10 Channel • 25 Watt Transceiver • Priority
The Regency RH250B is a ten-channel VHF land mobile transceiver designed to cover any frequency between 150 to 162 MHz. Since this radio is synthesized, no expensive crystals are needed to store up to ten frequencies without battery backup. All radios come with CTCSS tone and scanning capabilities. A monitor and night/day switch is also standard. This transceiver even has a priority function. The RH250 makes an ideal radio for any police or fire department volunteer because of its low cost and high performance. A 60 Watt VHF 150-162 MHz. version called the RH600B is available for \$454.95. A UHF 15 watt version of this radio called the RU150B is also available and covers 450-482 MHz, but the cost is \$449.95.

NEW! Bearcat® 50XL-GR

List price \$199.95/CE price \$114.95/SPECIAL
10-Band, 10 Channel • Handheld scanner
Bands: 29-54, 136-174, 406-512 MHz. The Uniden Bearcat 50XL is an economical, hand-held scanner with 10 channels covering ten frequency bands. It features a keyboard lock switch to prevent accidental entry and more. Also order part # BP50 which is a rechargeable battery pack for \$14.95, a plug-in wall charger, part # AD100 for \$14.95, a carrying case part # VC001 for \$14.95 and also order optional cigarette lighter cable part # PS001 for \$14.95.

NEW! Scanner Frequency Listings

The new Fox scanner frequency directories will help you find all the action your scanner can listen to. These new listings include police, fire, ambulances & rescue squads, local government, private police agencies, hospitals, emergency medical channels, news media, forestry radio service, railroads, weather stations, radio common carriers, AT&T mobile telephone, utility companies, general mobile radio service, marine radio service, taxi cab companies, tow truck companies, trucking companies, business repeaters, business radio (simplex) federal government, funeral directors, veterinarians, buses, aircraft, space satellites, amateur radio, broadcasters and more. Fox frequency listings feature call letter cross reference as well as alphabetical listing by licensee name, police codes and signals. All Fox directories are \$14.95 each plus \$3.00 shipping. State of Alaska-RL019-1; State of Arizona-RL025-1; Baltimore, MD/Washington, DC-RL024-1; Buffalo, NY/Erie, PA-RL009-2; Chicago, IL-RL014-1; Cincinnati/Dayton, OH-RL006-2; Cleveland, OH-RL017-1; Columbus, OH-RL003-2; Dallas/Ft. Worth, TX-RL013-1; Denver/Colorado Springs, CO-RL027-1; Detroit, MI/Windsor, ON-RL008-3; Fort Wayne, IN/Lima, OH-RL001-1; Hawaii/Guam-RL015-1; Houston, TX-RL023-1; Indianapolis, IN-RL022-1; Kansas City, MO/KS-RL011-2; Long Island, NY-RL026-1; Los Angeles, CA-RL016-1; Louisville/Lexington, KY-RL007-1; Milwaukee, WI/Waukegan, IL-RL021-1; Minneapolis/St. Paul, MN-RL010-2; Nevada/E. Central CA-RL028-1; Oklahoma City/Lawton, OK-RL005-2; Orlando/Daytona Beach, FL-RL012-1; Pittsburgh, PA/Wheeling, WV-RL029-1; Rochester/Syracuse, NY-RL020-1; San Diego, CA-RL018-1; Tampa/St. Petersburg, FL-RL004-2; Toledo, OH-RL002-3. New editions are being added monthly. For an area not shown above call Fox at 800-543-7892. In Ohio call 800-621-2513.

NEW! Regency® HX1500-GR

List price \$369.95/CE price \$239.95
11-Band, 55 Channel • Handheld/Portable
Search • Lockout • Priority • Bank Select
Sidelit liquid crystal display • EAROM Memory
Direct Channel Access Feature • Scan delay
Bands: 29-54, 118-136, 144-174, 406-420, 440-512 MHz. The new handheld Regency HX1500 scanner is fully keyboard programmable for the ultimate in versatility. You can scan up to 55 channels at the same time including the AM aircraft band. The LCD display is even sidelit for night use. Includes belt clip, flexible antenna and earphone. Operates on 8 1.2 Volt rechargeable Ni-cad batteries (not included). Be sure to order batteries and battery charger from accessory list in this ad.

Bearcat® 100XL-GR

List price \$349.95/CE price \$203.95/SPECIAL
9-Band, 16 Channel • Priority • Scan Delay
Search • Limit • Hold • Lockout • AC/DC
Frequency range: 30-50, 118-174, 406-512 MHz. The world's first no-crystal handheld scanner now has a LCD channel display with backlight for low light use and aircraft band coverage at the same low price. Size is 1 7/8" x 7 1/2" x 2 1/8". The Bearcat 100XL has wide frequency coverage that includes all public service bands (Low, High, UHF and "T" bands), the AM aircraft band, the 2-meter and 70 cm. amateur bands, plus military and federal government frequencies. Wow...what a scanner! Included in our low CE price is a sturdy carrying case, earphone, battery charger/AC adapter, six AA Ni-cad batteries and flexible antenna. Order your scanner now.

Bearcat® 210XW-GR

List price \$339.95/CE price \$209.95/SPECIAL
8-Band, 20 Channel • No-crystal scanner
Automatic Weather • Search/Scan • AC/DC
Frequency range: 30-50, 136-174, 406-512 MHz. The new Bearcat 210XW is an advanced third generation scanner with great performance at a low CE price.

NEW! Bearcat® 145XL-GR

List price \$179.95/CE price \$102.95/SPECIAL
10 Band, 16 channel • AC/DC • Instant Weather
Frequency range: 29-54, 136-174, 420-512 MHz. The Bearcat 145XL makes a great first scanner. Its low cost and high performance lets you hear all the action with the touch of a key. Order your scanner from CE today.

TEST ANY SCANNER

Test any scanner purchased from Communications Electronics™ for 31 days before you decide to keep it. If for any reason you are not completely satisfied, return it in original condition with all parts in 31 days, for a prompt refund (less shipping/handling charges and rebate credits).

NEW! Bearcat® 800XL-GR

List price \$499.95/CE price \$317.95
12-Band, 40 Channel • No-crystal scanner
Priority control • Search/Scan • AC/DC
Bands: 29-54, 118-174, 406-512, 806-912 MHz. The Uniden 800XL receives 40 channels in two banks. Scans 15 channels per second. Size 9 1/4" x 4 1/2" x 1 1/2".

OTHER RADIOS AND ACCESSORIES

Panasonic RF-2600-GR Shortwave receiver..... \$179.95
RD95-GR Uniden Remote mount Radar Detector..... \$128.95
RD55-GR Uniden Visor mount Radar Detector..... \$98.95
RD9-GR Uniden "Passport" size Radar Detector..... \$199.95
BC-WA-GR Bearcat Weather Alert™..... \$49.95
DX1000-GR Bearcat shortwave receiver SALE..... \$349.95
PC22-GR Uniden remote mount CB transceiver..... \$99.95
PC55-GR Uniden mobile mount CB transceiver..... \$59.95
R1060-GR Regency 10 channel scanner SALE..... \$92.95
MX3000-GR Regency 30 channel scanner..... \$229.95
XL156-GR Regency 10 channel scanner..... \$139.95
UC102-GR Regency VHF 2 ch. 1 Watt transceiver..... \$124.95
P1405-GR Regency 5 amp regulated power supply..... \$69.95
P1412-GR Regency 12 amp reg. power supply..... \$164.95
MA256-GR Drop-in charger for HX1200 & HX1500..... \$84.95
MA518-GR Wall charger for HX1500 scanner..... \$14.95
MA516-GR Carrying case for HX1500 scanner..... \$14.95
MA257-GR Cigarette lighter cord for HX1200/1500..... \$19.95
MA917-GR Ni-Cad battery pack for HX1200..... \$34.95
SMMX7000-GR Svc. man. for MX7000 & MX5000..... \$19.95
SMMX3000-GR Service man. for Regency MX3000..... \$19.95
B-4-GR 1.2 V AAA Ni-Cad batteries (set of four)..... \$9.95
B-8-GR 1.2 V AA Ni-Cad batteries (set of eight)..... \$17.95
FB-E-GR Frequency Directory for Eastern U.S.A..... \$14.95
FB-W-GR Frequency Directory for Western U.S.A..... \$14.95
ASD-GR Air Scan Directory..... \$14.95
SRF-GR Survival Radio Frequency Directory..... \$14.95
TSG-GR "Top Secret" Registry of U.S. Govt. Freq..... \$14.95
TIC-GR Techniques for Intercepting Comm..... \$14.95
RRF-GR Railroad frequency directory..... \$14.95
CIE-GR Covert Intelligence, Elect. Eavesdropping..... \$14.95
A60-GR Magnet mount mobile scanner antenna..... \$35.95
A70-GR Base station scanner antenna..... \$35.95
USAMM-GR Mag mount VHF/UHF ant. w/ 12' cable..... \$39.95
USAK-GR 3/4" hole mount VHF/UHF ant. w/ 17' cable..... \$35.95
USATLM-GR Trunk lip mount VHF/UHF antenna..... \$35.95
Add \$3.00 shipping for all accessories ordered at the same time.
Add \$12.00 shipping per shortwave receiver.
Add \$7.00 shipping per scanner and \$3.00 per antenna.

BUY WITH CONFIDENCE

To get the fastest delivery from CE of any scanner, send or phone your order directly to our Scanner Distribution Center. Michigan residents please add 4% sales tax or supply your tax I.D. number. Written purchase orders are accepted from approved government agencies and most well rated firms at a 10% surcharge for net 10 billing. All sales are subject to availability, acceptance and verification. All sales on accessories are final. Prices, terms and specifications are subject to change without notice. All prices are in U.S. dollars. Out of stock items will be placed on backorder automatically unless CE is instructed differently. A \$5.00 additional handling fee will be charged for all orders with a merchandise total under \$50.00. Shipments are F.O.B. Ann Arbor, Michigan. No COD's. Most products that we sell have a manufacturer's warranty. Free copies of warranties on these products are available prior to purchase by writing to CE. Non-certified checks require bank clearance. Not responsible for typographical errors.

Mail orders to: Communications Electronics, Box 1045, Ann Arbor, Michigan 48106 U.S.A. Add \$7.00 per scanner for R.P.S./U.P.S. ground shipping and handling in the continental U.S.A. For Canada, Puerto Rico, Hawaii, Alaska, or APO/FPO delivery, shipping charges are three times continental U.S. rates. If you have a Discover, Visa or MasterCard, you may call and place a credit card order. Order toll-free in the U.S. Dial 800-USA-SCAN. In Canada, order toll-free by calling 800-221-3475. WUI Telex anytime, dial 671-0155. If you are outside the U.S. or in Michigan dial 313-973-8888. Order today. Scanner Distribution Center™ and CE logos are trademarks of Communications Electronics Inc.

‡ Bearcat is a registered trademark of Uniden Corporation.
† Regency is a registered trademark of Regency Electronics Inc.
AD #070286-GR
Copyright © 1986 Communications Electronics Inc.

For credit card orders call
1-800-USA-SCAN

COMMUNICATIONS ELECTRONICS INC.
Consumer Products Division
P.O. Box 1045 □ Ann Arbor, Michigan 48106-1045 U.S.A.
Call 800-USA-SCAN or outside U.S.A. 313-973-8888
CIRCLE 79 ON FREE INFORMATION CARD



SATELLITE TV



BOB COOPER, JR.,
SATELLITE-TV EDITOR

Videocipher has been cracked



FIG. 1

UNLIKE 1985, 1986 WAS NOT A BANNER year for the home-TVRO industry. During 1985, about 500,000 TVRO systems were sold. Fewer than half that number were sold in 1986. Scrambling, or the fear of scrambling, caused the downturn. Dozens of equipment manufacturers, many more distributors, and thousands of dealers left the business, and most will never return.

Scrambling destroyed the TVRO industry because it was totally unprepared for the negative public reaction to scrambling. Not even the industry trade association SPACE (Society for Private And Commercial Earth Stations) was ready for the tremendous amount of adverse publicity that scrambling attracted.

Why did it happen? There is a wise, old adage in retailing: When the consumer is confused, he does (buys) nothing. The consumer was confused by the threat of scrambling, so he didn't buy. Therefore, because of the massive publicity given to scrambling by a small handful of programmers, it is now generally believed that home TVRO systems are relics of a past era.

There may be some truth in that belief because a significant proportion of those who bought a

dish between 1980 and 1985 did so primarily because the programming was free. Certainly it will never again be possible to purchase a dish system and tune in virtually everything in the sky.

Complicating our assessment of what has happened, however, are factors far more complicated than scrambling itself. First, although some (not many) services have scrambled, virtually all have been offered to dish owners. To avail oneself of that scrambled programming, you must purchase a descrambler unit for about \$400, and you must be willing to pay a monthly (or annual) fee to obtain one or more services.

So two new costs were added to owning and enjoying a satellite system: the descrambling hardware (see Fig. 1), and the programming software. The descrambler is a proprietary item produced only by M/A-Com (which was recently sold to GI) and its licensees. The software is 100% controlled by firms related to the cable television business. There have been Senate and House hearings regarding the scrambling situation during 1986; those hearings have attempted to determine whether M/A-Com and the cable programmers (like HBO) have violated any

anti-trust laws in their handling of scrambling.

Of course, the marketplace has reacted violently. Captain Midnight, last April, was but one (prominent) example of that negative reaction. Less visible have been numerous persons and groups who have been trying to "bust" the *Videocipher II* system. And it finally happened: *Videocipher has been busted.*

DES and M/A-Com

Videocipher II is protected by numerous U. S. laws. It uses the DES encryption system that, until April 22, 1987, may be protected from unauthorized busting by the National Security Agency. NSA is responsible for the security and integrity of the DES code, and uses it to transmit less-than-top-secret messages to military and embassy locations world-wide. In the M/A-Com view, anyone who tampers with DES or attempts to profit from decoding it is guilty of treason against the U. S. government. Obviously, charges of treason are not to be taken lightly.

Nonetheless, perhaps as many as several dozen persons or groups have, independent of one another, cracked *Videocipher II* and we have seen systems in operation. Their problem now concerns what they should do with their knowledge.

Anyone who attempted to sell "Blackcipher" boxes inside the U. S. would immediately be charged with several federal offenses, possibly including treason. M/A-Com warns *Videocipher II* distributors that the act of shipping a VC2000 satellite descrambler outside the

HITACHI OSCILLOSCOPES

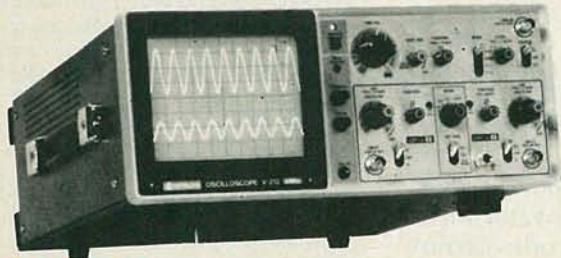

V-212

20 MHz Dual Channels

Convenient 0, 10, 90 and 100% amplitude markings, vertical mode triggering, 1mV/div. sensitivity & ±3% accuracy, TV sync separation circuit, X-Y mode, low drift.

\$429.



V222

20MHz Dual Channels

Same as above with DC offset to measure signals having DC components, CH1 output and DC offset voltage monitor outlet available for external counter or DVM*, alternate magnify function provides x1 and x10, sweep waveforms to be simultaneously displayed.

\$511.

*The purchase of a Model V222 oscilloscope entitles you to purchase a Revere Model RDMT10 3 1/2 digit, 10 amp. scale digital multi-meter for \$39.95! Regular price is \$49.95. Offer applies only to Hitachi Model V222.



WM. B. ALLEN SUPPLY COMPANY, INC.

ALLEN SQUARE

THE 300 BLOCK • NORTH RAMPART STREET

NEW ORLEANS • LOUISIANA 70112-3106

LOUISIANA TOLL FREE 800 462 9520 • NEW ORLEANS (504) 525 8222

CALL NATIONWIDE TOLL FREE

800 535 9593

24 HOURS A DAY!



"The ALLEN INDUSTRIAL ELECTRONICS GROUP highly recommends these fine Industrial Quality

Hitachi Oscilloscopes"

Richard S. Vialton MSEE
Sales Manager
ALLEN
INDUSTRIAL ELECTRONICS GROUP

HITACHI
SAVE UP TO \$850.00!

V1100A

100MHz/Quad Channels, 8-trace, delayed sweep, CRT readout, digital measurement.

\$2260.

V1070A

100MHz/Quad Channels, 8-trace, delayed sweep, CRT readout.....

\$1610.

V1050F

100MHz/Quad Channels, 8-trace, delayed sweep.

\$1395.

V650F

60MHz/Triple Channels, delayed sweep.....

\$1057.

V-422

40MHz, Dual Channels.

\$785.

VC6041UG

40MHz, sampling, dual channels, 1mV dual trace, 6" CRT, 4k words per channel, GPIB option.

\$5180.

VC6041UX

40MHz, digital storage, 1mV dual trace, 6" CRT, 4k words per channel.

\$4380.

V509

50MHz, dual channels, mini portable, delayed sweep.

\$1199.

V134

10MHz, dual trace, bi-stable storage.....

\$1395.

V209

20MHz, dual channels, AC-DC, mini portable.....

\$815.

THE 928 PAGE

WM. B. ALLEN
ELECTRONICS CATALOG
A \$15.00 VALUE

FREE!
WITH ANY PURCHASE



JANUARY 1987

U. S. may be construed as an act of treason, because U. S. laws state that exporting a DES decoder is illegal and that it is "an act against the state." In spite of that, however, between 25% and 30% of all *Videocipher II* units sold by W/A-Com to date have been exported, primarily to Mexico, the Caribbean and Central America.

A study of the law suggests that, although it may be illegal to export the *Videocipher II* units, and that it

is illegal to build and sell DES-decoding "Blackcipher" boxes inside the U. S., it is not illegal to design, manufacture, distribute, and use "Blackcipher" boxes outside the U. S., provided they never enter this country and that they are sold and used in countries which have no security or patent treaties with the U. S.

What's happening now is that, quietly, in small backwater locations where U. S. zip codes do not

Interested in TVRO?

For nearly two years Bob Cooper has provided a no-charge kit of printed materials that describes the challenges of and opportunities in selling TVRO systems today. With the present intense interest in scrambling systems, Coop's CSD has made available a new no-charge service.

The SCRAMBLE FAX hotline is a 24-hour-per-day telephone service that provides accurate, detailed, and hard-to-find facts concerning the changeover to scrambling in the satellite communications industry. Information describing satellite receivers tested for scrambling compatibility, sources for authorized descramblers, wholesale rates of scrambling equipment and services—all are provided on the SCRAMBLE FAX hotline. There is no charge for that service, other than your long-distance telephone expenses. Simply dial (305) 771-0575 for a concise and timely three-minute capsule report that covers the latest in scrambling news.

SEND COOP \$20



and HE WILL SEND YOU \$63!

NOPE - not a new fangled 'chain letter'. TVRO pioneer Bob Cooper, Jr. has put together the most useful 'Data-pack' possible to bring you up to full speed on satellite television scrambling. It will cost you \$20 to receive all of the following valuable information:

1) YOU RECEIVE the 3 'current issues' of **CSD Magazine**; literally, 'the bible' of the home dish industry. The most complete insider look at the new equipment, scrambling strategies, worldwide satellite explosive growth anywhere. You receive 3 issues starting with the now-current issue. A great introduction to TVRO! This is an **\$18 value**.

2) YOU RECEIVE the current plus two recent back issues of **SCRAMBLE-FAX**, the hot-news 'Newsletter' that details the rapid changes taking place in scrambling, who is scrambling, how; who is working to break scrambling, their progress to date. This is a **\$30 value**.

3) YOU RECEIVE the special 180 page **COMMEMORATIVE EDITION** OF Coop's Satellite Digest, the full, unabridged history of home satellite television. This is the handiest, one-source reference recording the home dish industry; a **\$15 value**.

YOU RECEIVE all of the facts, all of the history, and all of the current, hard-to-find news about TVRO and scrambling. From Coop; the industry's most authoritative information source. Send your check or money order to the address below, or, with your Visa or Mastercharge card handy, call in your order to 305/771-0505 weekdays between 9 AM and 4 PM. Join the Coop team and learn ALL the facts today!



CSD/Coop's Satellite Digest

P.O. Box 100858/Ft. Lauderdale, Fl. 33310
- Telephone 305-771-0505 -

SCRAMBLE-FAX HOTLINE? Call 305-771-0575 for 3 minute update NOW!

apply, people are using their specialized knowledge to build and then sell devices that defeat *Videocipher II* scrambling technology. The device costs between \$800 and \$1,200 (U. S.), which, on the surface may seem high, but which could actually turn out to be a bargain. The reason is that even a handful of scrambled programming sources could cost \$50 per month in the U. S. A box that decodes all *Videocipher II*-scrambled signals provides more than \$100 in monthly programming services. At \$1,000 for the box, in six months the box will pay for itself.

Inevitably, some of those "Blackcipher" units will find their way back into the U. S. where there are more than 1.5-million potential buyers of the offshore system. Undoubtedly, there are firms and persons who will seek to import those devices into the U. S. on a clandestine basis, or who will attempt to build and market similar units from inside the U. S.

Doing so could be risky, however. Offenders could be fined upwards of \$250,000 or sentenced to jail for 10 years—without considering possible charges of treason! So be warned that, although it may indeed be legal for someone in Aruba or St. Kitts to build, sell, and use such a decoder, it is clearly illegal to do so

continued on page 84

the fourth law of robotics

A robot shall make learning fun for man and thereby improve the quality of life for mankind.



A robot is a robot is a robot... was a robot. Until HERO 2000.

HERO 2000 is much more than a robot. It's a walking, talking 16-bit computer. With 64K ROM and 24K RAM expandable to more than half a megabyte. And a fully articulated arm with five axes of motion. Yours to program. Command. Modify and expand. Total system access and solderless experimenter boards provide almost limitless possibilities. Its remote RF console with ASCII keyboard gives total control. Available with three self-study courses. Backed by Heath Company, world leader

in electronic kits.

Build your own HERO 2000. Or buy it assembled. Have fun learning skills that translate directly to the world of work.

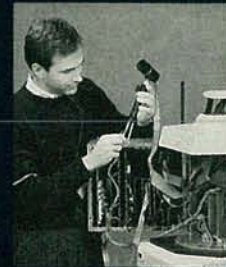

HERO[®] 2000

the
knowledge
builder

FREE. Send today for latest Heathkit Catalog.

Heathkit[®]
Heath
Company

A subsidiary of Zenith Electronics Corporation.



Mail coupon today to receive a **FREE** Heathkit Catalog featuring HERO 2000.

Mail to: Heath Company
Dept. 020-496
Benton Harbor, Michigan 49022

Name _____

Address _____

City _____ State _____

Zip _____

RO-141D

CIRCLE 181 ON FREE INFORMATION CARD

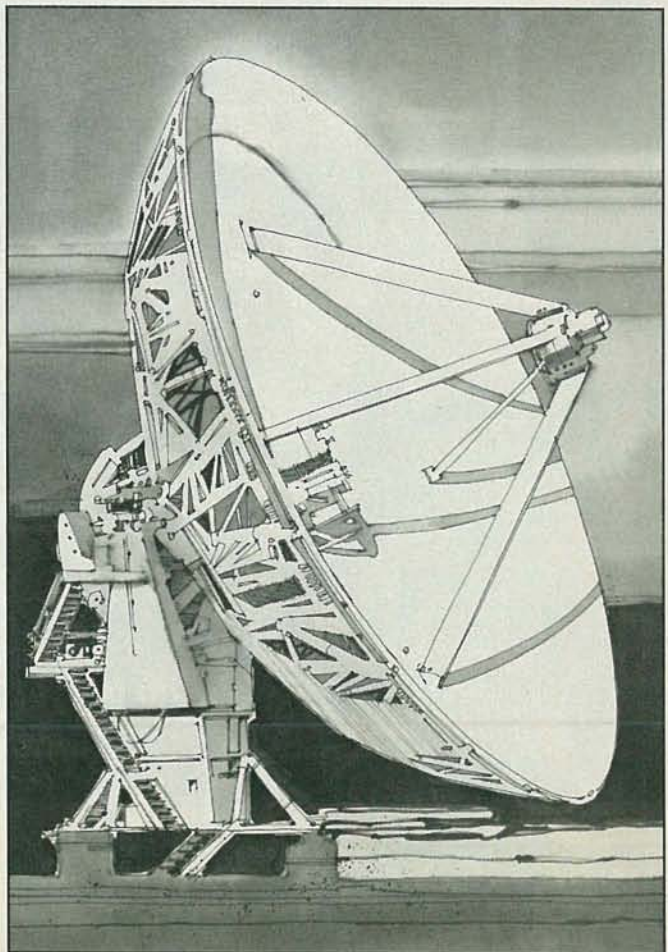
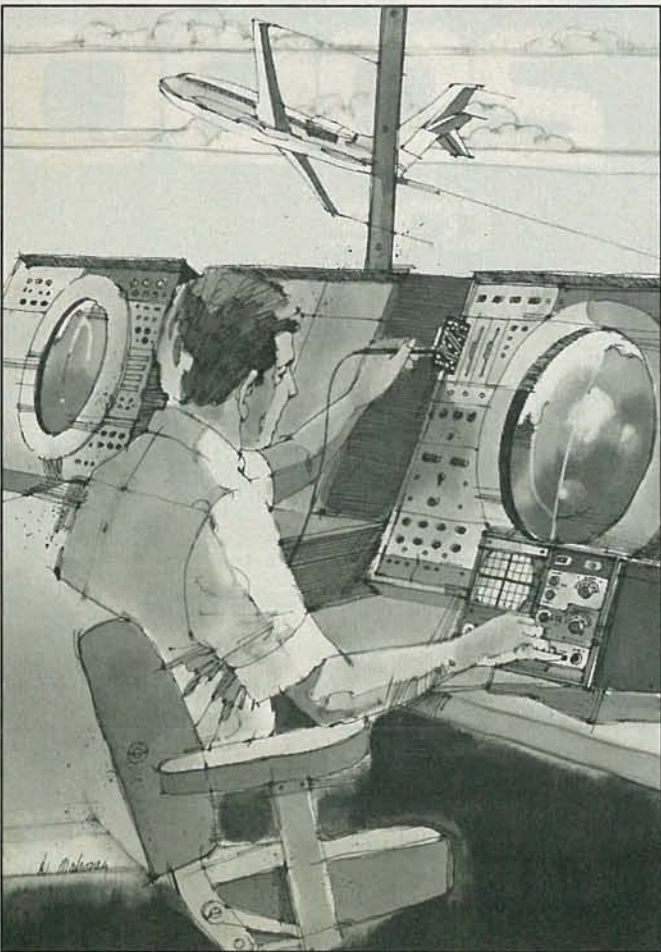
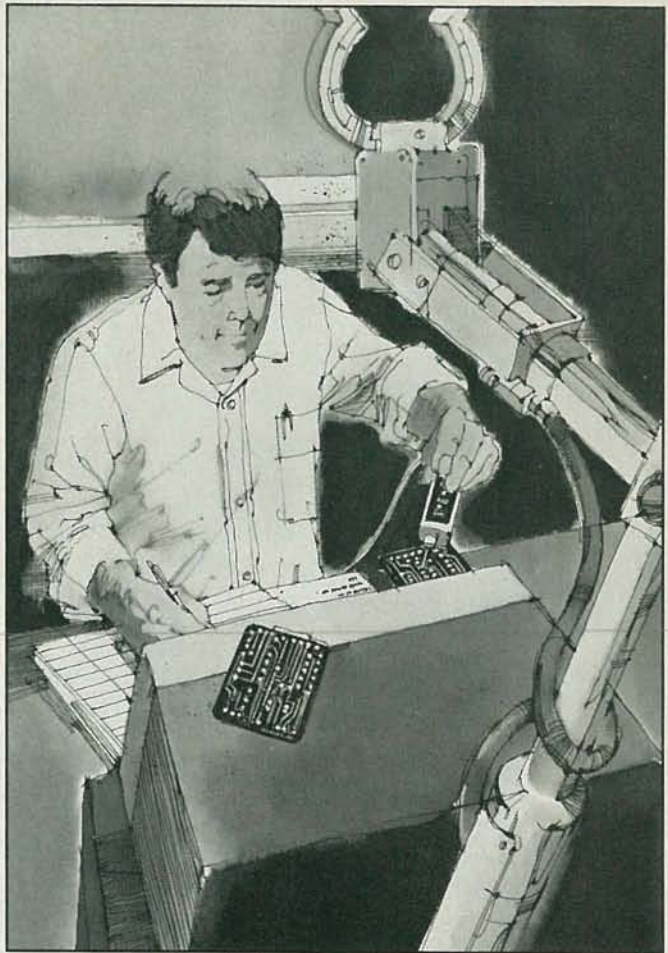

CIE MAKES THE WORLD OF ELECTRONICS YOURS.

Today's world is the world of electronics. To be part of it, you need the right kind of training, the kind you get from Cleveland Institute of Electronics, the kind that can take you to a fast growing career in business, aerospace, medicine, science, government, communications, and more.

Specialized training.

You learn best from a specialist, and that's CIE. We're the leader in teaching electronics through independent study, we teach only electronics and we've been doing it for over 50 years. You can put that experience to work for you just like more than 25,000 CIE students are currently doing all around the world.

Practical training.

You learn best with practical training, so CIE's Auto-Programmed® lessons are designed to take you step-by-step, principle-by-principle. You also get valuable hands-on experience at every stage with sophisticated electronics tools CIE-designed for teaching. Our 4K RAM Microprocessor Training Laboratory, for example, trains you to work with a broad range of computers in a way that working with a single, stock computer simply can't.

Personalized training.

You learn best with flexible training, so we let you choose from a broad range of courses. You start

with what you know, a little or a lot, and you go wherever you want, as far as you want. With CIE, you can even earn your Associate in Applied Science Degree in Electronics Engineering Technology. Of course, you set your own pace, and, if you ever have questions or problems, our instructors are only a toll-free phone call away.

The first step is yours.

To find out more, mail in the coupon below. Or, if you prefer, call toll-free **1-800-321-2155 (in Ohio, 1-800-523-9109)**. We'll send a copy of CIE's school catalog and a complete package of enrollment information. For your convenience, we'll try to have a representative contact you to answer your questions.

CIE Cleveland Institute of Electronics 1776 East 17th St., Cleveland, Ohio 44114

YES! I want to get started. Send me my CIE school catalog including details about the Associate Degree Program. I am most interested in:

- | | |
|--|---|
| <input type="checkbox"/> computer repair | <input type="checkbox"/> television/high fidelity service |
| <input type="checkbox"/> telecommunications | <input type="checkbox"/> medical electronics |
| <input type="checkbox"/> robotics/automation | <input type="checkbox"/> broadcast engineering |
| <input type="checkbox"/> other _____ | |

Print Name _____

Address _____ Apt. _____

City _____ State _____ Zip _____

Age _____ Area Code/Phone No. _____

Check box for G.I. Bulletin on Educational Benefits RE-52

Veteran Active Duty

MAIL TODAY!

EDITORIAL



Home Appliances

Alas, my dishwasher has spun through its last cycle. Rather than washing dishes, or listen to my wife complain about doing them, I grabbed her and our young son and off to the local appliance dealer. A quick trip up and down the aisles revealed that electronics has finally been applied to dishwashers.

A few milliseconds of thinking it over and I decided that the electronic model was the way to go. Why? Simple! As we in the electronics industry know, touch-sensitive switches and logic circuits are far more reliable than the mechanical push switches and electro-mechanical timers used in the past. That is the same decision I arrived at when we purchased our electric range last year.

The installation day finally arrived. I went home from work to discover that the dishwasher was indeed installed and my wife hadn't arrived home yet. This gave me a few minutes to ponder a few things.

First, I wondered why the appliance industry took 10 years to become up to date. Maybe large industries move slowly, after all look at the automotive industry. No, that couldn't be true, the electronics industry is large and we have no trouble advancing the state-of-the-art. That line of thinking made me feel proud to be a part of the electronics industry and thankfully lucky that I can contribute.

Next, I pondered all those digital signals running through the appliances I now have in my kitchen. Why couldn't my appliances talk to each other? Why would I want that? Maybe so that I don't have to reset all those darn clocks after a power outage. I have a clock in my AT&T *Genesis* telephone, one in my coffee maker so there's a fresh brewed cup of coffee when I wake up, one in my microwave oven, another in the electric range, and of course there's a wall mounted clock so that I know what time it is! Another reason is that it is the first step towards the computerized home.

The method for appliances to communicate with each other is referred to as a home-bus. The appliance industry and electronics industry has talked for awhile about establishing a standard for the home-bus. A lot of lip-flapping is going on, but apparently, we are getting nowhere fast. The last lesson learned was in the TV industry. They unsuccessfully tried to standardize the hand-held infra-red remote control. Now we have very expensive remote controls that learn the infra-red codes from other manufacturer's. Who pays in the end? The consumer.

Come on guys. Get off your duffs and set a home-bus standard.

Art Kleiman
Editorial Director

SUPER VALUES from JOSEPH ELECTRONICS

Hitachi SCOPES Full 3-year warranty



V1050F 100 MHz QUAD CHANNEL/8-TRACE DELAYED SWEEP SCOPE. The features you want and need ■ 500uV Sens. ■ 2% Accuracy ■ 6" CRT has internal graticule. 20KV acceleration. One-touch sync of TV-V, TV-H. Plus: autofocus; variable hold-off; trace rotation adjust; X-Y operation; 10X magnification. W/probes, dust cover.

Reg. \$1,595 **Sale Price \$1,198**

V650F 60 MHz TRIPLE-TRACE DELAYED SWEEP SCOPE. As above, except has 10KV acceleration, 1 MV sensitivity, 3% accuracy, triple trace. W/probes.

Reg. \$1,195 **Sale Price \$898**

CALL TOLL-FREE
1-800-323-5925
FREE SHIPPING to U.P.S.
Shippable Destinations



V422 40 MHz DUAL-CHANNEL SCOPE ■ Low profile portable ■ DC offset, 1 MV sensitivity, 3% accuracy. 6" CRT with internal graticule. Alternate magnification for simultaneous display of x1, x10 swept waveforms! Plus vertical mode triggering; auto-focus; TV sync separation circuit; built-in signal delay; X-Y Mode. Only 12 x 5 x 14 1/2". 14.3 lbs. W/probes.

Reg. \$925 **Sale Price \$678**

V222 20 MHz DUAL-CHANNEL SCOPE. Similar to above, except has 20 MHz bandwidth. W/probes.

Reg. \$715 **Sale Price \$538**

FLUKE DMM'S



MODEL 37-NEW 3 1/2 DIGIT BENCH DMM. 0.1% DC accuracy ■ Analog/Digital ■ Auto-ranging ■ Volt, Ohms, Amps, Diode Testing ■ 30kHz AC Bandwidth ■ Fused 10A Range ■ Storage compartment—2 year warranty.

Reg. \$229 **Sale \$198**



MODEL 8060A-4 1/2 DIGIT, TRUE RMS DMM
True RMS AC volt and amp measurement ■ 0.04% basic DC accuracy ■ Fast audible/visual continuity tests ■ Relative reference (offset) ■ Low-power ohms on all resistance ranges ■ Constant-current diode test mode ■ Resistance measurements to 300 MΩ ■ Frequency and dB measurements.

Reg. \$349 **Sale \$308**



MODEL 8050A-4 1/2 DIGIT, BENCH DMM
0.03% basic DC accuracy ■ True rms AC voltage and current measurement, AC to 50 KHz. ■ Conductance function checks high resistance to 100,000 MΩ ■ high power or low-power ohms ■ Five voltage ranges, 200 mV to 1000V ■ Extensive overload protection ■ Diode and dB measurement.

Reg. \$389 **Sale \$338**

HAND-HELD 3 1/2 DIGIT DMM'S



MODEL 73
Analog/digital display ■ Volts, ohms, 10A, diode test ■ Autorange ■ 0.7% basic DC accuracy ■ 2000+ hour battery life ■ 3 year warranty

Reg. \$79 **Sale \$68**

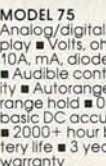

MODEL 77
Analog/digital display ■ Volts, ohms, 10A, mA, diode test ■ Audible continuity ■ "Touch Hold" Function ■ Auto-range/range hold ■ 0.3% basic DC accuracy ■ 2000+ hour battery life ■ 3 year warranty ■ Multipurpose holster

Reg. \$139

Reg. \$99 **Sale \$88** **Sale \$118**

OK TEST INSTRUMENTS



Model 203 2 MHz Function Generator
■ 0.2 Hz to 2 MHz Function Generator ■ Sine, Square, Triangle Waveforms ■ External Sweep 1000:1 ■ TTL and 50 Ohm Outputs ■ Variable DC Offset ■ Wt. 2.6 lbs. 10.2 x 6 x 2"

Reg \$289 **Sale \$258**



Ultra-Portable Mini-Scope Model 1010
■ 10 MHz Full-Featured Oscilloscope ■ AC or Battery operated with internal battery charger ■ 10 mV Sensitivity, 21 Time Base Ranges ■ Internal or External Trigger ■ Bright, clear Blue/White CRT ■ Wt. 2 lb; 10.2 x 6 x 2"

Reg. \$385 **Sale \$338**



Model 515 600 MHz Frequency Counter
■ 8 Digit 1/2" LED Display ■ Wide Frequency Range: 5 Hz to 600 MHz ■ 10 mV RMS Sensitivity throughout range ■ 2 ppm Time Base Accuracy ■ AC or DC Powered (AC Adaptor Included) ■ Wt. 1.8 lbs. 10.2 x 6 x 2"

Reg. \$340 **Sale \$308**

Model 512, 200 MHz Handheld Counter
Reg. \$145 **Sale \$128**

LIMITED TIME OFFER WHILE QUANTITIES LAST, PHONE TODAY TOLL-FREE!

1-800-323-5925 (In Illinois 1-312-297-4200)

VISA-MASTERCARD-DISCOVER
CARDS WELCOMED. OPEN ACCOUNT
ORDERS TO RATED COMPANIES.
ILLINOIS RESIDENTS ADD 7% TAX.

**FREE 116 page Joseph Electronics
discount instrument catalog with
your order or on request!**

**Joseph
Electronics**
8830 N. Milwaukee Ave.,
Niles, IL 60648

WHAT'S NEWS

Perpendicular disk allows very-high density recording



MAXELL'S NEW 100 MEGABYTE PERPENDICULAR RECORDING DISK.

Perpendicular disk allows very-high density recording

Maxell has developed a new 100-megabyte perpendicular recording-disk with a substantially improved high-density recording capability. It works on the principle that more people can occupy a given space standing shoulder to shoulder than lying down side by side.

"The new disk provides significantly more magnetic surface than standard recording media by standing its magnetic particles perpendicular to the plane of the substrate rather than laying them flat on the plane's surface," explains Mark Welland, national sales and marketing manager of Maxell's Computer Products Division. The company is located at 60 Oxford Dr., Moonachie, NJ 07074.

"To complete the analogy," says Welland, "picture the magnetic particles like a thickly-clustered crowd of people, standing in a field."

One result of that technological

breakthrough is a decided improvement in recording density capability to 100 kilobytes-per-inch.

"And unlike a standard fixed disk, the perpendicular recording disk has the added advantages of being removable and transportable," Welland adds.

A main feature of the new Maxell disk is improved perpendicular Co-Cr magnetization. That is achieved by sandwiching germanium thin-film between flexible substrates. In conjunction with the disks, and with Hitachi, Ltd., Maxell jointly has developed a recording head of amorphous metal-ferrite complex that provides better head-surface contact than standard heads.

Some other important specifications of the newly introduced Maxell Co-Cr thin-film media for perpendicular recording include a magnetic layer thickness of 0.2 μ (microns), an increased recording density of 100 kilobytes-per-inch, and a magnetic force of 800 oersteds.

"Emmys" are awarded for stereo television

An Emmy award for "Outstanding Achievement in the Science of Television Engineering" was presented to dbx, Inc. for its role in the development of television stereo. The award by the National Academy of Television Arts and Sciences was made last September 10, in New York City.

Other Emmy awards were given to NBC, the EIA, and Zenith for their contributions to, and the implementation of, stereo TV.

Antique wireless group holds three-day conference

More than 800 radio enthusiasts, amateurs, and radio historians gathered in Canandaigua, NY this past September 25 through 27 for the three-day Antique Wireless Association conference. The record number of attendees participated in amateur sessions, presentations of papers, and equipment and tube auctions, and viewed the many exhibits.

The theme of the old-equipment contest was "1986 is Tesla Year," and the "Best of Show" award was presented to amateur Alan Douglas for a 40-piece exhibit of Tesla literature. The items in the exhibit ranged from the 1893 Martin book on the life, writing, and speeches of Nikola Tesla, to Tesla's articles, "My Life and Works," which appeared in Hugo Gernsback's *Electrical Experimenter*. Other exhibits of note included a completely restored Pilot Super-Wasp and a complete collection of ancient railroad telegraph equipment, including some rare early machines.

Some record prices were realized in the tube auction. A de Forest "singer" transmitting tube, with its accompanying rectifier, sold for \$510. A de Forest spherical Audion brought \$350. **R-E**

LEADER



Sometimes it's hard to go back for a scope!

60-MHz full-function field-service Attache Case Oscilloscope is so light and small it will be taken everywhere, every time.

LBO-325 packs all the power and performance of a cumbersome, backbreaking, 60-MHz workbench oscilloscope into an easy-to-carry, ultra-compact, featherweight unit. Although its 3½-inch CRT is as big and clear as screens on large field-service scopes—LBO-325 weighs only 9 lbs. So it won't weigh field-technicians down, no matter how far afield they go! LBO-325 is so small it fits inside a 3-inch deep attache case with room to spare for a multimeter, service manuals and some tools. The ideal full-function scope for a cramped work area or crowded bench.

Reduces the cost of service calls.

Time is money. A scope left in the vehicle takes time to retrieve. One kept in the shop causes repeat service calls. The LBO-325

Attache Case Oscilloscope is so easy to carry and use, techs will take it everywhere, every time. And the time saved translates into extra profits for years to come.

Outperforms all other portables:

- 60 MHz • Dual channel • ALT TIME BASE simultaneously displays main waveform and any expanded portion
- ALT TRIG for stable display of 2 asynchronous signals • Bright, sharp 12-kV trace • Large 3½-inch PDA CRT • Illuminated graticule
- Comprehensive triggering • TV-V and TV-H sync separators • Variable trigger hold-off • Delay line shows sharp leading edges • CH-1 output drives low-sensitivity instruments
- Measures only 3 x 9 x 11¾ inches • Weighs 9 lbs.

Two-year warranty.

Built tough to provide long use, LBO-325 is backed by Leader's 30-year reputation for reliability and by factory service depots on both coasts.

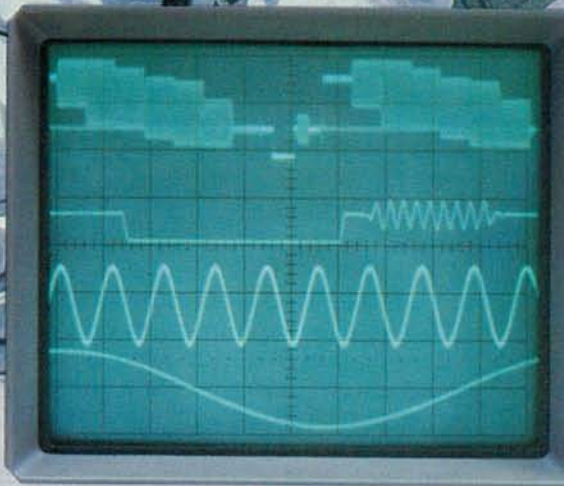

LBO-325 CRT is shown actual size.

Call toll-free
(800) 645-5104
In NY State
(516) 231-6900

Request an evaluation sample, our latest Test Instrument Catalog with over 100 outstanding products, the name and address of your nearest "Select" Leader Distributor, or additional information.

For professionals who know the difference.
LEADER
Instruments Corporation

380 Oser Avenue
Hauppauge, New York 11788
Regional Offices: Chicago, Dallas
Los Angeles, Boston, Atlanta
In Canada call Omnitrax Ltd.
(514) 337-9500

CIRCLE 195 ON FREE INFORMATION CARD

VIDEO NEWS



DAVID LACHENBRUCH,
CONTRIBUTING EDITOR

• **LCD projection TV.** Television-set manufacturers are now evaluating a completely new kind of projection TV—one that uses three transparent liquid-crystal displays as “light valves.” The system was developed by Seiko Epson Co and uses a projector that weighs about nine pounds and is the size of a cigar box. Seiko Epson says that the unit can project an image that varies in diagonal measurement from 10 to 80 inches. The first prototypes have shortcomings, particularly in brightness and resolution, but the company thinks that those can be overcome and that a satisfactory model can be developed in about two years. It is expected that such a unit will sell in the \$1,000 range.

The projector's light source is a specially designed 300-watt halogen bulb. Current prototypes feature resolutions of about 220 by 320, or 70,400 pixels and have a brightness of 70 foot-lamberts on a 40-inch screen. The three LCD's, one for each primary color, are of the active-matrix thin-film type. A dichroic mirror and dichroic prism position the images for projection through a single lens, eliminating the need for convergence. Although TV manufacturers who have seen the Seiko Epson projector agree that it currently has many shortcomings, none is willing to rule it out as a potential consumer product, particularly in view of its extreme portability and potential low price.

• **More tiny camcorders.** The war of the mini-camcorders, 8mm vs. VHS-C, continues unabated. JVC, which has been attacking Sony's *Handycam* because it won't play back, has introduced its own version, which looks remarkably like the *Handycam* and won't play back either. The JVC unit weighs just over two pounds and will be marketed in the United States in the Spring. Meanwhile, Sony, which is marketing two relatively large size record-and-play 8mm camcorders, which it calls its *Pro 8* line, now is adding the *Auto Handycam*, a three-pound record-and-playback model with infrared autofocus, auto white-balance, electronic viewfinder, and zoom lens. In Japan, Sony announced it would manufacture twice as many

Auto Handycams as record-only *Handycams*. Both the *Auto Handycam* and JVC's new playback-only VHS-C machine should be available under other brand names as well.

• **“Addressing” a VCR.** A new uniform feature approved by the VHS group and soon to appear in high-end recorders is the digital “address code.” That is an indexing system for quick location of videotaped segments. There's nothing new about that, but what is new is that the user can make up any four-digit number—it can be year and month, month and day, elapsed time, the reading on the tape counter, cueing numbers for editing sequence, etc.—and insert it in the tape while recording or playing back. When the number is recalled by entering it on the remote-control unit, the proper location is found on the tape. As an aid, the number appears on the screen.

• **Now it's a 41-inch tube.** Suddenly some picture-tube screens sizes are larger than some projection-TV screens. While 35- and 37-inch rear-projection systems have become increasingly popular, sets with direct-view 35-inch color tubes have now become available from Mitsubishi and Sharp, and are expected under other brand names. Mitsubishi has also displayed a 40-inch tube. Not to be outdone, Matsushita has announced a 41-inch size. If you're thinking of sending away for one to put in your homemade-TV set, the initial samples are available at \$3,225 each. That doesn't include shipping the tube, which weighs about 187 pounds.

• **Audio on video.** Want to know a good use for TV channels when no TV signal is being broadcast? How about digital audio? That's just what Boston's FM public-radio station, WGBH, is doing in the daytime before its UHF-television affiliate, WGBX-TV, goes on the air. Under an FCC experimental license, WGBH's digitally recorded concerts and CD programs are being encoded into a special PCM format for broadcasting over the TV channel. The signal may be received and recorded on home VCR's that are equipped with Sony PCM digital-audio processors. **R-E**

Save up to \$1,369 on scanners with these valuable coupons. See our advertisement in *Radio Electronics* magazine to find the scanner of your choice. Then send in the money saving coupon with your order and payment. Order today.



Consumer Products Division
 P.O. Box 1045 □ Ann Arbor, Michigan 48106-1045 U.S.A.
 Call 800-USA-SCAN or outside U.S.A. 313-973-8888

COUPON COUPON COUPON

SAVE \$359.05
Regency® RH250B-GF

Programmable 25 Watt Transceiver

List Price \$659.00

Now only \$299.95 plus \$7.00 shipping.

This coupon must be included with your prepaid order. Credit cards and quantity discounts are excluded from this offer. Offer valid only on prepaid orders mailed directly to Communications Electronics Inc., P.O. Box 1045 - Dept. SCAN, Ann Arbor, Michigan 48106-1045 U.S.A. Coupon expires February 28, 1987. Coupon may not be used in conjunction with any other offer from Communications Electronics Inc. Limit one coupon per transceiver.

COUPON COUPON COUPON

SAVE \$222.00
Bearcat® 800XLT-GF

12-Band, 40 Channel, No crystal scanner

List Price \$499.95

Now only \$277.95 plus \$7.00 shipping.

This coupon must be included with your prepaid order. Credit cards and quantity discounts are excluded from this offer. Offer valid only on prepaid orders mailed directly to Communications Electronics Inc., P.O. Box 1045 - Dept. SCAN, Ann Arbor, Michigan 48106-1045 U.S.A. Coupon expires February 28, 1987. Coupon may not be used in conjunction with any other offer from Communications Electronics Inc. Limit one coupon per scanner.

COUPON COUPON COUPON

SAVE \$165.00
Bearcat® 100XL-GF

9-Band, 16 Channel, No crystal scanner

List Price \$349.95

Now only \$184.95 plus \$7.00 shipping.

This coupon must be included with your prepaid order. Credit cards and quantity discounts are excluded from this offer. Offer valid only on prepaid orders mailed directly to Communications Electronics Inc., P.O. Box 1045 - Dept. SCAN, Ann Arbor, Michigan 48106-1045 U.S.A. Coupon expires February 28, 1987. Coupon may not be used in conjunction with any other offer from Communications Electronics Inc. Limit one coupon per scanner.

COUPON COUPON COUPON

SAVE \$165.00
Bearcat® 210XW-GF

8-Band, 20 Channel, No crystal scanner

List Price \$339.95

Now only \$174.95 plus \$7.00 shipping.

This coupon must be included with your prepaid order. Credit cards and quantity discounts are excluded from this offer. Offer valid only on prepaid orders mailed directly to Communications Electronics Inc., P.O. Box 1045 - Dept. SCAN, Ann Arbor, Michigan 48106-1045 U.S.A. Coupon expires February 28, 1987. Coupon may not be used in conjunction with any other offer from Communications Electronics Inc. Limit one coupon per scanner.

COUPON COUPON COUPON

SAVE \$140.00
Regency® HX1500-GF

11-Band, 55 Channel, No crystal scanner

List Price \$369.95

Now only \$229.95 plus \$7.00 shipping.

This coupon must be included with your prepaid order. Credit cards and quantity discounts are excluded from this offer. Offer valid only on prepaid orders mailed directly to Communications Electronics Inc., P.O. Box 1045 - Dept. SCAN, Ann Arbor, Michigan 48106-1045 U.S.A. Coupon expires February 28, 1987. Coupon may not be used in conjunction with any other offer from Communications Electronics Inc. Limit one coupon per scanner.

COUPON COUPON COUPON

SAVE \$125.00
Regency® Z60-GF

8-Band, 60 Channel, No crystal scanner

List Price \$299.95

Now only \$174.95 plus \$7.00 shipping.

This coupon must be included with your prepaid order. Credit cards and quantity discounts are excluded from this offer. Offer valid only on prepaid orders mailed directly to Communications Electronics Inc., P.O. Box 1045 - Dept. SCAN, Ann Arbor, Michigan 48106-1045 U.S.A. Coupon expires February 28, 1987. Coupon may not be used in conjunction with any other offer from Communications Electronics Inc. Limit one coupon per scanner.

COUPON COUPON COUPON

SAVE \$102.00
Uniden® RD55-GF

Ultra Sensitive Visor Mount Radar Detector

List Price \$199.95

Now only \$97.95 plus \$7.00 shipping.

This coupon must be included with your prepaid order. Credit cards and quantity discounts are excluded from this offer. Offer valid only on prepaid orders mailed directly to Communications Electronics Inc., P.O. Box 1045 - Dept. SCAN, Ann Arbor, Michigan 48106-1045 U.S.A. Coupon expires February 28, 1987. Coupon may not be used in conjunction with any other offer from Communications Electronics Inc. Limit one coupon per radar detector.

COUPON COUPON COUPON

SAVE \$91.00
Bearcat® 50XL-GF

10-Band, 10 Channel, No crystal scanner

List Price \$199.95

Now only \$108.95 plus \$7.00 shipping.

This coupon must be included with your prepaid order. Credit cards and quantity discounts are excluded from this offer. Offer valid only on prepaid orders mailed directly to Communications Electronics Inc., P.O. Box 1045 - Dept. SCAN, Ann Arbor, Michigan 48106-1045 U.S.A. Coupon expires February 28, 1987. Coupon may not be used in conjunction with any other offer from Communications Electronics Inc. Limit one coupon per scanner.

COUPON COUPON COUPON

COUPON COUPON COUPON

CIRCLE 176 ON FREE INFORMATION CARD

LETTERS



INFORMATION NEEDED

I am a graduate of the University of Akron, with an Associate Degree in Electronics Technology. I also have military and industrial experience in electronics. Yet, I am still having difficulty finding employment in my career field.

I have tried newspapers, my local unemployment office, my college placement office, and even the public library, all with no results when it comes to information about who's hiring. Could any of your readers give me any information on how to find out who is hiring, where, in the electronics industry? Any such help would be greatly appreciated.

MICHAEL D. HARDY
131 Tremont, S.E., Room 325,
Massillon, OH

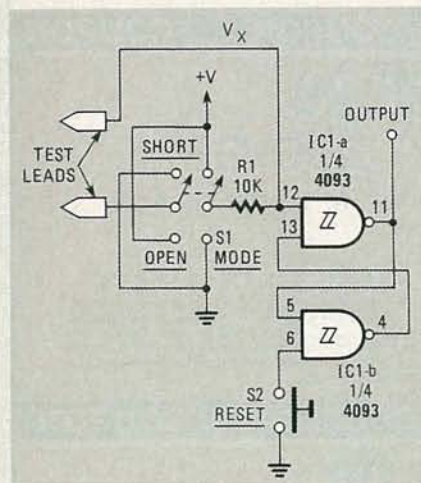

FIG. 1

OOOOPS!

In Fig. 3 of the Latching Continuity Tester (November 1986), switch S1 is wired incorrectly. The correct wiring is shown in the circuit fragment in Fig. 1 here. Although not shown in Fig. 1, we should also note that the lead of BZ1 shown to ground should go to +V. We apologize for any prob-

lems those errors may have caused.—Editor

TV DESCRAMBLING BOOK

In the November installment of our series, "TV Signal Descrambling," you were kind enough to note that we are preparing a book dealing with the same subject. The correct title is *Video Scrambling and Descrambling for Satellite and Cable TV*, catalog number 22499,

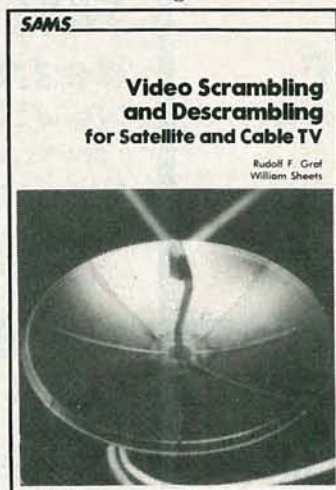

FIG. 2

published by Howard W. Sams & Co., 4300 West 62nd Street, Indianapolis, IN 46286. It is shown in Fig. 2.

RUDOLF GRAF and
WILLIAM SHEETS

We apologize to Rudy, Bill, and Howard W. Sams & Co. for printing the incorrect information.

TV-SIGNAL DESCRAMBLING

After reading the current articles on TV Signal Descrambling, the elaborate and esoteric methods used to keep a few hackers and those in the hinterlands from seeing the broadcasters' emanations, my question is: Why?

A review of this week's offerings from the birds on my local cable, from "Fraggle Rock" to 40-year-old

movies played for the 17th time this year, leads me to the conclusion that the general public mentality is even lower than the network executives think it is.

My major concern is this: With the cable companies and bird operators finding out that there is little market for their garbage, and with the encoding so simple and foolproof, the next thing is that pay-TV will move to the local HF-VHF stations and we will have to rent a decoder to see "Miami Vice" and David Brinkley. And will the political candidates issue free half-hour harangues, good only in the period that they have paid for, or would we have to pay for that, too?

And it's called *Premium Programming—yecch!*

M. F. OBERG
Rocklin, CA

HURRAH FOR CAPTAIN MIDNIGHT

I read your article, "The Raid on HBO," in the October 1986 *Radio-Electronics* with much interest.

In my opinion, someone should have given "Captain Midnight" a medal for being so brave. The only reason I myself didn't do something like what he did is that I don't know enough about satellites. I feel that the people who scramble programs are stealing not only from those who receive the program but from those who pay for the ads on the program.

You see, I am a rebel. Back before many of you were born, I was in radio. That was back in the 1930's; as a teenager, I thought it was wrong for the government to tell me that I couldn't have a broadcasting station. The government doesn't own the airwaves—they belong to God. So a friend and I built a transmitter and we put it on the air. We operated that sta-

tion for over a year and made money from commercials. But the government eventually caught up with us, with the help of someone who was jealous because he didn't have the guts to do the same thing himself. I just hope that more "Captain Midnights" appear.

I really enjoy your magazine, and hope that you continue to publish articles like "The Raid on HBO." I also enjoy articles on building satellite-TV descramblers.

I have been a reader of your magazine for many years; in fact, I have many copies dating back to the 1930's and 1940's.

R. M. BLOMQUIST
Westlake, LA

GRAVITY WAVES

The article on gravity waves, by Gregory Hodowanec, in the April 1968 *Radio-Electronics* was thought-provoking. The theory behind his gravity-wave detector captivates the imagination and theoretically must have a certain degree of validity.

I will not hazard a guess as to

how much validity the theory has, but I suspect that the circuit that Mr. Hodowanec has shown produces its own input, excluding a small input from $1/f$. The nulling offset voltage pins are not included in his circuit, and offset voltage increases in a 741 op-amp when the level of the feedback voltage increases.

When the input terminal is grounded, the output should also, ideally, be at zero—although, because of imbalances within the IC, that doesn't always happen. Practical op-amps are not ideal. Due to the difference of minority current carriers, and slight differences in the manufacturing process, the impurities added to the transistors are not exactly the same from one transistor to the other. The larger the feedback resistance, the larger the offset voltage.

Try this: Install a different op-amp as an input for the capacitor and note the difference. I suspect that you will find that the output of the second will produce a measurable difference. Even by nulling the op-amp and maintaining a sta-

ble temperature, an internal temperature and component (gain) difference will produce a slowly ringing output with no applied input signal.

A capacitor has inductance at higher frequencies (another contributing input) along with the wires to the capacitor. A radiation (UHF antenna?) input can be out of phase with the offset voltage anywhere from a little over zero to 180° .

TOM SMITH
Champaign, IL

MORE ON GRAVITY WAVES

Your article on gravity waves (*Radio-Electronics*, April 1986) seems to have attracted the usual crop of bizarre characters. (When I was interviewing people for an electronics position, I noted quite a few of those scatterbrained pseudo-scientists among the applicants.) The gravity-wave detection ability of the electrolytic capacitor seems plausible, as the wave could travel through and squeeze the plates together, creating a signal—but the problem here

SCOPE PRICE BREAKTHROUGH!

New B&K-PRECISION Dual-Trace 20MHz Scope... \$440!!

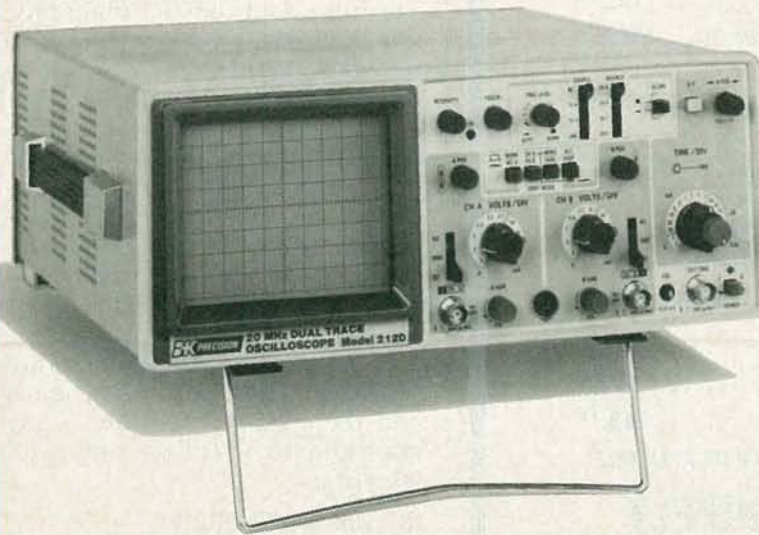

Now you can own a professional quality 20MHz, dual-trace scope for under \$450. Best of all, it's a full featured instrument, from B&K-PRECISION—famous for quality, dependable products.

Compare these outstanding features, then compare price!

- Dual or single trace operation • 2mV/div sensitivity
- 20MHz response at a true -3dB • AUTO/NORM triggered sweep operation with AC, TVH, TVV and Line coupling
- Calibrated 18 step timebase with x10 magnifier • X-Y operation
- Bright, sharp rectangular CRT with P31 phosphor
- Front-panel trace rotation control • Tilt stand and soft handle • Selectable +/- slope • Built-in calibration source
- Compact low-profile design.

For immediate delivery, contact your local B&K-PRECISION distributor or call B&K-PRECISION today.

B&K PRECISION DYNASCAN CORPORATION

6460 West Cortland Street • Chicago, Illinois 60635 • 312/889-9087
International Sales, 6460 W. Cortland St., Chicago, Illinois 60635 • Canadian Sales, Atlas Electronics, Ontario
South and Central American Sales, Empire Exporters, Plainview, NY 11803

CIRCLE 77 ON FREE INFORMATION CARD

is that an MC1451 (Motorola—the other makes don't work for some reason) happens to be a highly sensitive RF detector; so it is impossible to say *what* that circuit measures, without the following test.

Place both detector and signal source in well-grounded, copper and iron Faraday cages, detector on cushioned rotating plate, transmitter on cushioned and grounded surface, consisting of a heavy metal object, grounded,

being moved at a certain rate of vibration by some means that does not produce EMI. (Perhaps an encapsulated battery-powered motor could be used?)

Such a setup could conceivably determine if the detector has anything to do with gravity waves (or whether it could detect the fact that there are some sorts of currents being produced in the flexing wires or vibrating mechanism that are getting through all your shielding. Or magnetic effects due

to Earth's field on the moving metal object!)

On another subject: Someone asked for an IC to produce composite sync. Fairchild MOS type 3262 does it.

PIERRE MIHOK
Ontario, Canada



FIG. 3

STILL AVAILABLE

The kits and parts for the Humidity Monitor (shown in Fig. 3) from the February 1986 issue of **Radio-Electronics** are still available at the prices listed in that article. However, we have recently moved. Our new address and phone number is: Mark C. Worley, 10614 Golden Quail Drive, Austin, TX 78758 (512) 832-0759. An SASE and note will get you the latest information and update sheets.
MARK C. WORLEY

UNSUSPECTED SOURCE

In the October 1986 issue of **Radio-Electronics**, Mr. Fitch requested useful information (or leads to same) for antique-radio enthusiasts, such information to be included in a future "Antique Radios" department.

I wish to call your attention to the fact that complete antique-radio tube data, basing diagrams, and radio formulae pertinent to old radio construction is found in a rather unlikely publication: *Handbook of Chemistry and Physics*, 24th edition, 1940-1941.

The publisher is still in business: Chemical-Rubber Publishing Co. (CRC Press), 18901 Ctanwood Parkway, Cleveland, OH 44128. (I believe that that is their current address.)

The 24th and earlier editions are probably available in the "science and technology" section of any good public or college engineering library.

ROGER RAVENSBORG
Saint Paul, MN

R-E

★ **CABLE TV SPECIALS** ★

CONVERTERS

- JERROLD: DRZ-3DIC105—66 Channel Wireless \$199.⁹⁵
- JRX-3 DIC—36 Channel Corded Remote..... \$149.⁹⁵
- JSX-3 DIC—36 Channel Set Top..... \$129.⁹⁵
- SB-3—'The Real Thing' \$119.⁹⁵

- MAGNAVOX: 6400—60 Channel Wireless w/Parental Lockout for Jerrold systems..... \$199.⁹⁵

- ZENITH: Z-TAC Cable Add-On..... \$225.⁰⁰

- VIEW STAR: EVSC-2000—60 Channel Wireless— with Parental Lockout..... \$ 99.⁹⁵
- EVSC-2000A-B—Same as above with A-B Switch \$109.⁹⁵
- View Star 1000—60 Channel Wireless..... with Volume \$119.⁹⁵

MISCELLANEOUS

- OAK: N-12 Mini-Code \$ 89.⁹⁵
 - N-12 Mini-Code Vari-Sync..... \$109.⁹⁵
 - N-12 Mini-Code Vari-Sync Plus Auto On-Off .. \$165.⁰⁰

 - JERROLD: 400 & 450 Handheld Transmitters..... \$ 29.⁹⁵

 - HAMLIN: MLD-1200 \$ 99.⁹⁵

 - NEW ITEMS: Standard Components—66 Channel Wireless— with Parental Lockout \$ 99.⁹⁵
 - Scientific Atlanta **Call for Price**
 - Power Zapper Stun Gun, 46, 000V..... \$ 59.⁹⁵
 - K-40 Radar Detector—Dash Model \$199.⁹⁵
 - K-40 Radar Detector—Remote..... \$229.⁹⁵
- ALL UNITS GUARANTEED. QUANTITY PRICES AVAILABLE.

UNITED ELECTRONIC SUPPLY

P.O. BOX 1206 • ELGIN, ILLINOIS 60121 • 312-697-0600

PERFORMANCE

THAT IS OUT OF THIS WORLD...



\$389⁰⁰
MODEL 2000 20MHz
DUAL TRACE

\$549⁰⁰
MODEL 3500 35MHz
DUAL TRACE DELAYED SWEEP

...AT A DOWN TO EARTH PRICE

At last! Truly affordable test equipment with no compromise in design, and features you would expect to find only on oscilloscopes costing hundreds of dollars more! JDR Instruments presents two, new, high-performance models backed by a two year warranty and technical support which is only a phone call away. Perfect for the technician or advanced hobbyist, both models feature Dual Trace capability and a variety of operating and triggering modes, including CH-B Subtract and X-Y operation.

MODEL 2000 has a 20 MHz bandwidth and 20 calibrated sweeps ranging from .2s to .2 μ s. A convenient built-in component tester provides additional diagnostic power.



CIRCLE 59 ON FREE INFORMATION CARD

MODEL 3500 features a 35 MHz bandwidth and exceptional 1mV/DIV sensitivity. Delayed sweep and variable holdoff allow stable viewing of complex waveforms.

ORDER TOLL FREE
800-538-5000
800-662-6279 (CA)

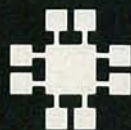

JDR INSTRUMENTS
1224 South Bascom Avenue
San Jose, California 95128 (408) 995-5430

EQUIPMENT REPORTS

Pencept Penpad 320

This intelligent tablet cuts CAD and data-entry chores down to size.

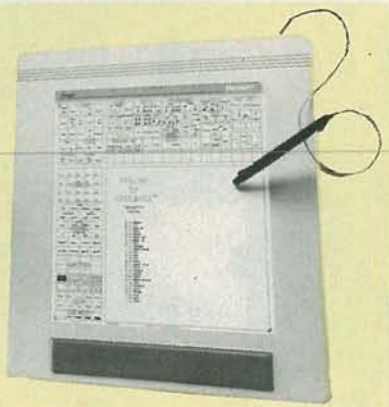

CIRCLE 9 ON FREE INFORMATION CARD

POLITICS MAKES STRANGE BED-fellows—but so does technology. For example, what makes the the IBM-PC the IBM-PC is its Intel microprocessor, the 8088. So a Motorola 68000 would be the last thing you'd expect to find inside an IBM. Surprise—Pencept (39 Green Street, Waltham, MA 02154) have done it! They've tucked a 68000 and about 200K of EPROM in the IBM on an expansion card, and its union with the 8088 has produced some exciting results.

We'll Help You Make Ends Meet.

With Fully Shielded, FCC Compliant AP Products brand RS-232 Adaptors

- 7 Standard configurations – 2 Gender Changers, 5 Pin-out Adaptors.
- Short .920" housing length, excluding connectors.
- FCC compliant – fully shielded – rated 60dB minimum.
- Rugged die-cast and riveted construction.
- Tin plated connector interfaces, coated covers.
- Device wire schematic and part number clearly labeled.
- Male connectors feature exclusive spring clip design assuring ground continuity.
- Gold over Nickel plated contacts.
- Exclusive Molded-in construction.
- Hardware appropriate for connector is provided as standard.
- Custom configurations and private label programs available.

For more information call Associated Electronics/3M today. For immediate



response contact a local authorized AP Products Prototype & Test Devices distributor. Or telephone 800-321-9668 or (216) 354-2101 in Ohio for further information.

We Solve Problems.

Associated Electronics/3M

AP Products Prototype & Test Devices
9325 Progress Parkway, P.O. Box 540
Mentor, Ohio 44060

CIRCLE 76 ON FREE INFORMATION CARD

3M

Pencept's product is a digitizing tablet called the *Penpad 320*. No big deal, you say. True, there are dozens of digitizing tablets, and, given minor differences, they're all basically the same. But the *Penpad* is different—radically different. It's got at least as much smarts built right on its single-slot expansion card as the IBM motherboard it mates with. What use are all those smarts put to? Good question. The answer is: character recognition.

The pad

The *Penpad* measures about 16 × 17 inches and has an active area of about 11 × 11 inches. A pen with a single pushbutton switch mounted near the tip is what you use to enter graphics and text. A single cable attaches the *Penpad* to a "D" connector mounted on the expansion card.

How you use the pen depends on the kind of program you're using it with. There are three basic uses: in applications programs (word processors and spreadsheets), DOS, and CAD programs. For example, in an application program you can press and hold the pen button and then use the pen to move the cursor, more or less like a mouse.

Pencept supplies a special template for using the *Penpad* with DOS. You mount the template at the top of the active area, leaving an 8½ × 11 inch area for use with forms. (More on forms below.) Then, by merely touching the pen to the template, you can simulate pressing keys at the keyboard. The function keys are represented on the template, as are the cursor keys, and the shift, alt, control, escape, backspace, enter, and other keys.

In addition, there is a "scratchpad" area for (literally) writing in commands. Anything you write in the scratchpad area will appear on the screen; you can edit your entries from the *Penpad* by touching the appropriate squares (backspace, etc.) Then touch the enter square (or press the button), and your command will be executed, just as if you had typed it at the keyboard.

Not bad. But the real excitement comes when you use the *Penpad*

Exclusive, triple patented dynamic cap and coil analyzing . . . guaranteed to pinpoint your problem every time or your money back



with the all new LC75 "Z METER 2"
Capacitor Inductor Analyzer
Patented \$995

The "Z METER" is the only LC tester that enables you to test all capacitors and coils dynamically — plus, it's now faster, more accurate, and checks Equivalent Series Resistance (ESR) plus small wire high resistance coils.

Eliminate expensive part substitution and time-consuming shotgunning with patented tests that give you results you can trust every time. Test capacitor value, leakage, dielectric absorption, and ESR dynamically; with up to 600 volts applied for guaranteed 100% reliable results — it's exclusive — it's triple patented.

Save time and money with the only 100% reliable, in- or out-of-circuit inductor tester available. Dynamically test inductors for value, shorts, and opens, automatically under "dynamic" circuit conditions.

Reduce costly parts inventory with patented tests you can trust. No more need to stock a large inventory of caps, coils, flybacks, and IHVTs. The "Z METER" eliminates time-consuming and expensive parts substituting with 100% reliable LC analyzing.

Turn chaos into cash by quickly locating transmission line distance to opens and shorts to within feet, in any transmission line.

Test troublesome SCRs & TRIACs easily and automatically without investing in an expensive second tester. The patented "Z METER 2" even tests SCRs, TRIACs, and High-Voltage Diodes dynamically with up to 600 volts applied by adding the new SCR250 SCR and TRIAC Test Accessory for only \$148 or FREE OF CHARGE on Kick Off promotion.

To try the world's only Dynamic LC Tester for yourself, CALL TODAY, WATS FREE, 1-800-843-3338, for a FREE 15 day Self Demo.



Call Today Wats Free 1-800-843-3338

SENCORE

3200 Sencore Drive
Sioux Falls, SD 57107
605-339-0100 In SD Only

*innovatively designed
with your time in mind.*

CIRCLE 177 ON FREE INFORMATION CARD

JANUARY 1987

23

Learn micro-processing with the new
MICRO-PROFESSOR 1P



Students, engineers or technicians—
upgrade your micro-processing skills
with the new Micro-Professor 1P.

The MPF-1P features:

- extensive software support
- more built-in memory
- improved keyboard
- larger display

Three tutorial guides help cover all capabilities. The ideal training tool! MPF-1P will deliver you into the growing world of micro-processing. Invest now!

Plus—FREE GIFT Only **\$199.95**

Check this box for **FREE** Z-80 Microprocessor Programming and Interfacing textbook when you order within 7 days. \$16.95 value. (Include \$7.50 postage & handling)



Dept. RE-0187
5326 9th Ave. N.E.
Seattle, WA 98105-3617

For immediate action call TOLL FREE:

1-800-426-1044

Full money back guarantee.
Pictured with optional printer



CIRCLE 111 ON FREE INFORMATION CARD

	Pencept		Penpad 320							
OVERALL PRICE										
EASE OF USE										
INSTRUCTION MANUAL										
PRICE/VALUE										
	1	2	3	4	5	6	7	8	9	10
	Poor		Fair			Good			Excellent	

with a CAD program like AutoCAD, the premier (and de facto standard) computerized drafting program. In fact, Pencept has a special template, an interface program, and a menu system that makes using AutoCAD much, much easier.

The template includes a small area for text entry and a few built-in command squares (flip screen, backup drawing, and main menu). You use the command squares merely by touching the pen to the tablet in the square. To flip between text and graphics screens,

for example, just touch the pen to the Flip Screen square. Five command squares are empty, and you can customize them to perform your most needed functions.

The interface program (Pencad) and the menu system allow you to use the pen like a mouse in navigating the menus. AutoCAD's menus appear on the right side of the screen, and, normally, as you type in commands at the keyboard, the menus change to show current options. With the *Penpad*, you just touch the pen to the surface of the right side of the tablet to perform menu functions. The menus change to reflect the current context, just as if you had typed commands at the keyboard. Of course, you can also literally write commands (and drawing text) in the text boxes at the top of the template.

There's even more. Pencad has a built-in (and totally re-configurable) set of "recognition macros." They allow you to execute some of the most commonly used Auto-

Send Purchase Order
Check, Money Order, or C.O.D.
or Call Toll Free
800-223-0826
in N.Y. State (212) 865-5580
#1 IN CABLE BOXES

\$69.95

JERROLD CORDLESS CABLE TV CONVERTER STARCOM CS-V

- Volume control
- 68 channels
- Mute control
- Automatic fine tuning
- Instant channel recall
- Programmable to go on at a particular channel and off automatically
- Compatible with descramblers



\$109.95 / 10 up
\$129.95/1-4 \$119.95/5-9

JERROLD CORDLESS CABLE TV CONVERTERS

MODEL DRX3-105/400

- 58 channels
- Remote channel changing
- Remote on/off switch
- Remote fine tuning

EXTRA HAND REMOTES
REM 400 - \$29.95



JERROLD CORDLESS CABLE TV CONVERTER

MODEL DRZ/450

\$69.95 / 10 lot
\$79.95 ea.
• 66 channels
• Automatic fine tuning • A/B switch option



JERROLD CORDED CABLE TV CONVERTER MODEL JRX3-105

\$49.95
• 36 channels
• push button



"THE RABBIT" VIDEO MULTIPLYING SYSTEM TR-7000

\$51.95 / 12 up
\$59.95/6-11
\$69.96/1-5



IT'S LIKE HAVING A VCR IN EVERY ROOM

■ MASTER CARD ■ VISA

OMNITRON ELECTRONICS

770 Amsterdam Ave., New York, NY 10025

SHIPPING CHARGES

For Orders	Add
\$25-100	\$6.50
\$100-500	\$8.50
\$500-750	\$10.50
\$750 and up	\$20.00



CIRCLE 110 ON FREE INFORMATION CARD

CAD commands (Zoom, Redraw, Copy, etc.) from anywhere on the tablet merely by pressing the pen button, holding it in, and writing a key letter of the desired command (Z for Zoom, R for Redraw, C for Cancel, Y for Copy, etc.)

Everything is re-configurable. You can build your own entirely customized set of AutoCAD menus and then thoroughly integrate them with the *Penpad* by designing your own template and recognition macros. With careful design, you could build a system that required an absolute minimum of keyboard input by your draftsman.

Other versions of Pencil are available for CADVANCE and FreeLance; check with Pencil if you want to use the *Penpad* with other CAD programs.

Other uses

Pencil has several additional application programs for the *Penpad*. One is called Penform; it allows you to create professional-looking forms. You can plot the forms you create and copy them or have them printed. In addition, you can use them with a separate data-input program that allows you to write the data on a form that lies on the *Penpad*. The data entered in that manner is stored on disk in ASCII or DIF (*Data Interchange Format*). DIF is used to share data between different spreadsheets. You can then use a spreadsheet or a DBMS program to analyze the data.

Pencil's other application program is Pencil. It is advertised as a business presentation program that allows you to prepare "slide shows" of graphs and drawings. In effect, it is a miniature CAD program with a few special features.

Our impressions

Configuring the interface card and driver software can be a little confusing; it requires comprehension of the IBM's interrupt and I/O port structure. After the proper configuration is determined, though, driver loading can be done with batch files.

After using the *Penpad* with AutoCAD for about an hour, you'll never want to go back to typing at
continued on page 71

Analyze defective waveforms faster, more accurately, and more confidently — every time or your money back



with the SC61 Waveform Analyzer
Patented \$2,995

If you value your precious time, you will really want to check out what the exclusively patented SC61 Waveform Analyzer can do for you. 10 times faster, 10 times more accurate, with zero chance of error.

End frustrating fiddling with confusing controls. Exclusive ultra solid ECL balanced noise cancelling sync amplifiers, simplified controls, and bright blue dual trace CRT help you measure signals to 100 MHz easier than ever.

Accurately and confidently measure waveforms from a tiny 5 mV all the way to a whopping 3,000 V without hesitation with patented 3,000 VPP input protection — eliminates expensive "front end" repairs and costly equipment downtime.

Make only one circuit connection and push one button for each circuit parameter test: You can instantly read out DC volts, peak-to-peak volts and frequency 100% automatically with digital speed and accuracy. It's a real troubleshooting confidence builder.

Confidently analyze complex waveforms fast and easily. Exclusive Delta measurements let you intensify any waveform portion. Analyze glitches, interference signals, rise or fall times or voltage equivalents between levels; direct in frequency or microseconds.

Speed your digital logic circuit testing. Analyzing troublesome divide and multiply stages is quicker and error free — no time-consuming graticule counting or calculations. Simply connect one test lead to any test point, push a button, for test of your choice, for ERROR FREE results.

To see what the SC61 can do for your troubleshooting personal productivity and analyzing confidence, CALL TODAY, WATS FREE, 1-800-843-3338, for a FREE 15 day Self Demo.



Call Today Wats Free 1-800-843-3338

SENCORE

3200 Sencore Drive
Sioux Falls, SD 57107
605-339-0100 In SD Only

*innovatively designed
with your time in mind.*

CIRCLE 178 ON FREE INFORMATION CARD

Train for the Fastest Growing Job Skill in America

Only NRI teaches you to service all computers as you build your own 16-bit IBM-compatible micro

Now that computers are firmly established in offices by the millions—and in homes, too—the demand for trained computer service technicians surges forward. The Department of Labor estimates that computer service jobs will actually *double* in the next ten years—a faster growth rate than for any other occupation.

Total systems training

No computer stands alone... it's part of a total system. And if you want to learn to service and repair computers, you have to understand computer *systems*. Only NRI includes a powerful

computer system as part of your training, centered around an IBM-PC compatible computer.

No other training is so complete

As part of your training, you'll build a highly rated 16-bit IBM-compatible computer system, assemble the "intelligent" keyboard, install the power supply and disk drive, and interface the high-resolution monitor with your computer—it's confidence-building, real-world experience that includes training in programming and circuit design.

Even if you've never had any

previous training in electronics, you can succeed with NRI at-home training.

No experience necessary, NRI builds it in

You'll start with the basics, then rapidly build on them to master such concepts as digital logic, microprocessor design, and computer memory. You'll build and test advanced electronic circuits using the exclusive NRI Discovery Lab, professional digital multimeter, and logic probe. Like your computer system, they're all yours to keep as part of your hands-on training.

Learn Computer Servicing Skills with NRI's "Hands-On" Training...



Using NRI's unique Action Audio Cassette, you are talked through the operation and practical application of your hand-held digital multimeter—the basic, indispensable tool for the computer specialist.



You'll set up and perform electronics experiments and demonstrations using your NRI Discovery Lab. You'll even interface the lab with your computer to "see" keyboard-generated data.



After you build this digital logic probe, you'll explore the operation of the Sanyo detached "Intelligent" keyboard and its dedicated microprocessor.

NEW
Now Fully IBM PC
Compatible!

NRI training now includes the fully IBM compatible Sanyo 880 Series Computer. It runs programs almost as fast as an IBM PC. It also includes a multipurpose function I-O card for extended expansion capabilities with up to seven slots available for such additions as: internal clock/calendar, Hayes modem, serial ports, extended graphics, etc.

Your NRI total systems training includes: NRI Discovery Lab to design and modify circuits; four-function digital multimeter with walk-you-through instruction on audio tape; digital logic probe for visual examination of computer circuits; the latest Sanyo 880 Series Computer with "intelligent" keyboard and 360K double-density, double-sided disk drive; high resolution monochrome monitor; 8K ROM, 256K RAM; bundled software including GW BASIC, MS DOS, WordStar, CalcStar; reference manuals, schematics, and bite-sized lessons.

Send for 100-page free catalog

See all the training equipment you get in this exciting, state-of-the-art computer course, including the educator-acclaimed NRI Discovery Lab, digital multimeter, and logic probe. Read detailed descriptions of each lesson, each experiment you perform. And check out other NRI high-tech training like Robotics,

Digital Electronics Servicing, Data Communications, TV/Audio/Video Servicing, and more.

Mail the postage-paid card today, and see how NRI can prepare you for advancement, a new career—even a business of your own in the exciting world of electronics. If the card has been used, write to NRI at the address to the right.

NRI SCHOOL OF ELECTRONICS

McGraw-Hill Continuing Education Center
3939 Wisconsin Avenue
Washington, DC 20016



We'll give you tomorrow

as You Build Your Own Sanyo Computer System.



The power supply is assembled in the main unit of the computer. You check out keyboard connections and circuits with the digital multimeter included for training and field use.



Next, you install the disk drive. You learn disk drive operation and adjustment, make a copy of MS-DOS operating disk and begin your exploration of the 8088 CPU.



Using the monitor, you focus on machine language programming, an indispensable troubleshooting tool for the technician. You continue by learning BASIC language programming.

Scan and record temperatures from freezing to scorching.



The new Fluke 52 goes to great extremes to outperform any other handheld thermometer.

At the touch of a button, it sequentially scans the readouts of two temperature inputs and their difference. Or records the minimum and maximum from any one of these three channels for up to 1,200 hours.

You can measure extreme temperatures with 1/10th of a degree resolution, using standard K or J type thermocouples probes.

Prices for the Fluke 50 Series are surprisingly low... starting at just \$119 for the single-input Fluke 51. Order yours today.

For the name of your local supplier and a free brochure call toll-free 1-800-227-3800, Ext. 229.

FROM THE WORLD LEADER IN HANDHELD TEST INSTRUMENTS.

FLUKE 51/52 THERMOMETERS

Measurement range:

K-type: -200°C to +1370°C (-328°F to +2498°F)

J-type: -200°C to +760°C (-328°F to +1400°F)

Accuracy:

K-type is ±(0.1% of reading + 0.7°C or 1.3°F)

J-type is ±(0.1% of reading + 0.8°C or 1.4°F)

°C or °F Selectable • Hold Mode

Scan, Differential, and Min/Max Recording Modes (52 only)

Standard mini-connector input

1200 hour 9V battery life • 3-year warranty

General-purpose K-type bead probe included (two with 52)

©1986 Fluke



CIRCLE 121 ON FREE INFORMATION CARD

NEW PRODUCTS



CIRCLE 30 ON FREE INFORMATION CARD

EARTH-STATION RECEIVER, the model *ESR2400*, is micro-processor-controlled and contains its own built-in power supply; also built in to the receiver is the *VideoCipher II* decoder module. (Consumers have the option of buying the model *ESR2400* without the decoder module and adding it at a later date if they wish.)

The on-screen display shows all pertinent functions and parameters, such as channel, satellite, polarity, and signal strength. There is priority view, which allows up to 19 channels to be preprogrammed for instant viewing. The viewer then need only press one button

on the remote control, and the right satellite, channel, polarization, and audio format will be selected automatically.

Other features include parental lock-out, positioning program-mability (up to 30 memories) stereo reception, Ku-band compatibility (up to 50 channels), block-system technology, full-function infrared remote control, and signal-strength indicator for precision tuning.

The model *ESR2400* has a suggested retail price of under \$1500.00.—**R. L. Drake Company**, P.O. Box 112, Miamisburg, OH 45342.

DMM, the model *DM1000*, is a card-sized, 3½-digit, autoranging digital multimeter. It is self-contained in a vinyl case, with probes attached, folds to 4.5" high × 3" wide × 0.5" deep, and weighs three ounces. The unit tests and measures AC/DC volts, ohms, and continuity, and performs diode checks.

Called the "Checkman Mini," the model *DM1000* features 0.7% basic DC accuracy, easy-to-read 0.4" high LCD, and attached probes to ensure immediate operation. Volt and ohm ranges have built-in autoranging to save testing time. AC/DC voltage ranges are 2 volts to 450 volts. Ohm ranges are from 2 kilohms to 2 megohms. An

MAKE MORE MONEY



Do You REALLY Want to Make More Money?

Yes it does take *work* and a few sacrifices to climb up the electronics ladder to where the bigger money is. But, if that's where you want to be, then that's what you must do — *work* harder at learning and getting the right credentials, even if it takes a few sacrifices. A *B. S. degree* and the knowledge that rightly goes along with it can give you powerful ladder-climbing equipment in your search for *success in electronics*.

The accredited Grantham non-traditional B.S. Degree Program is intended for mature, fully-employed workers who want to upgrade their electronics careers.

TRAIN FOR ELECTRONICS

You say you're *already* trained in electronics but that you're *not* making enough money??? Well then, maybe you don't have an accredited bachelor's degree to prove that your education is *up to snuff!* Check out the Grantham Independent-Study B. S. Degree Program. It could make a *dollars and sense difference* in your electronics career.

Grantham offers this program, complete but without laboratory, to electronics technicians whose objectives are to upgrade their level of technical employment. Since the field of electronics is so enormous, opportunity for advancement is always present. Promotions and natural turnover make desirable positions available to the man who is ready to *move up*.

Grantham College of Engineering
10570 Humbolt Street
Los Alamitos, California, 90720

Put Professional Knowledge and a COLLEGE DEGREE in your Electronics Career through Independent Home Study

Study materials, carefully written by the Grantham College staff for independent study at home, are supplied by the College. Your technical questions related to these materials and the lesson tests are promptly answered by the Grantham home-study teaching staff.

Recognition and Quality Assurance

Grantham College of Engineering is accredited by the Accrediting Commission of the National Home Study Council, as a degree-granting institution.

All lessons and other study materials, as well as communications between the college and students, are in the English language. However, we have students in many foreign countries; about 80% of our students live in the United States of America.

This booklet
FREE!

This free booklet explains the Grantham B.S. Degree Program, offered by independent study to those who work in electronics.



for
FREE
Booklet
CLIP
COUPON
and mail in
envelope or
paste on
postal
card.

Grantham College of Engineering R-1-87
10570 Humbolt Street, Los Alamitos, CA 90720

Please mail me your free catalog which explains your B.S. Degree independent-study program.

Name _____ Age _____

Address _____

City _____ State _____ Zip _____

JANUARY 1987

easy-to-hear tone indicates continuity. The device operates on two 1.5-volt batteries, and the display automatically signals when they need to be changed. There is a one year warranty.



CIRCLE 31 ON FREE INFORMATION CARD

The model *DM1000* has a suggested list price of \$27.95.—**Siber Hegner North America, Inc.**, 5 Landmark Square, Stamford, CT 06901.

CLOCK/TIME RECEIVER, the model *OEM-10*, provides the user with precise time by receiving and decoding the WWV and WWVH radio signals broadcast by the

National Bureau of Standards (NBS). The receiver signals are synchronized to within 10 milliseconds of the NBS atomic clock. The time information includes days, hours, minutes, and seconds, as well as tenths and hundredths of a second.

The model *OEM-10* receiver section consists of a five-channel,

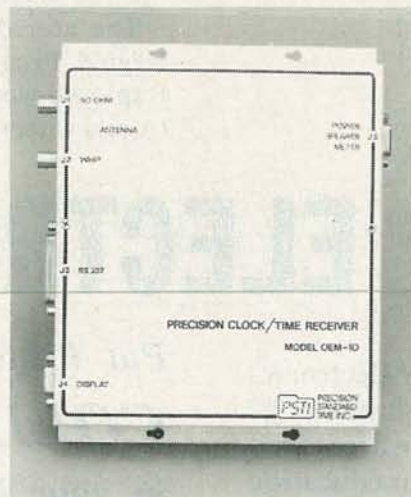

CIRCLE 32 ON FREE INFORMATION CARD

crystal-controlled, dual-conversion, superheterodyne receiver with an audio amplifier. The signal-processing section includes both analog and digital filters. The microprocessor section monitors and controls all the data-acquisition and data-correction activities. The data-output section includes an RS-232C interface, as well as a TTL-level serial interface and an optional LED display. The receiver, filters, microprocessor, and serial interfaces are enclosed in a rugged, low-profile aluminum case.

Typical applications for the model *OEM-10* include incorporation into master-clock systems, energy-management systems, computers, remote-sensing and data-recording devices, etc.

The model *OEM-10* is priced at \$450.00.—**Precision Standard Time, Inc.**, 2585 Scott Blvd., Santa Clara, CA 95050.

1-MHz FUNCTION GENERATOR, the model *FG 1001*, is a circuit board, modularly designed to fit

COPPER ELECTRONICS

4200 PRODUCE ROAD - LOUISVILLE, KENTUCKY 40218

Call us **FREE 1-800-626-6343**

or write for **FREE** Flyer.

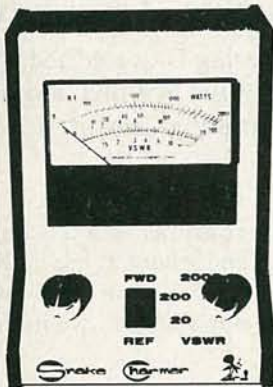

Snake Hammer

WATTMETER
69.95

SPCIFICATIONS:

- * Power Range: 20, 200, 2000 Watts
- * VSWR: Voltage Standing Wave Reading
- * Peak Reading During modulation
- * Accuracy +/-5 percent on dead carrier

We have a national factory warranty service on many brands, and we service All CB, Amateur, and Commercial Equipment.

THE LOWEST PRICES IN THE COUNTRY!

CIRCLE 125 ON FREE INFORMATION CARD

NOISE REDUCTION FOR UNDER \$10.

MIXING CONSOLES

SWITCHES

MICROPHONE CONNECTORS

SNAKE CABLES

BATTERY CONTACTS



ALL PLUGS & JACKS (XLR, PHONE, PHONO, DIN, MIDI, ETC.)

PATCHBAYS

FADERS, POTS

TERMINAL STRIPS

SPEAKER TERMINALS

CRAMOLIN®

Even the finest equipment in the world cannot guarantee noise-free operation. One "dirty" connection anywhere in the electrical path can cause unwanted noise or signal loss.

"MORE THAN A CONTACT CLEANER"

CRAMOLIN® is a fast-acting, anti-oxidizing lubricant that cleans and preserves all metal surfaces, including gold.

When applied to metal contacts and connectors, **CRAMOLIN®** removes resistive oxides as it forms a protective molecular layer that adheres to the metal surfaces and maintains maximum electrical conductivity.

CRAMOLIN® - USED BY THOSE WHO DEMAND THE BEST:

Bell & Howell	Hewlett Packard	MCI(Sony)	Nakamichi
Boeing	John Fluke Mfg.	Motorola	RCA
Capitol Records	McIntosh Labs	NASA	Switchcraft

SINCE 1956

CAIG LABORATORIES INC.

1175-O Industrial Ave., (P.O. Box J) - Escondido, CA 92025-0051 U.S.A. • (619) 743-7143

CIRCLE 188 ON FREE INFORMATION CARD

REACH FOR RELIABILITY



RCA

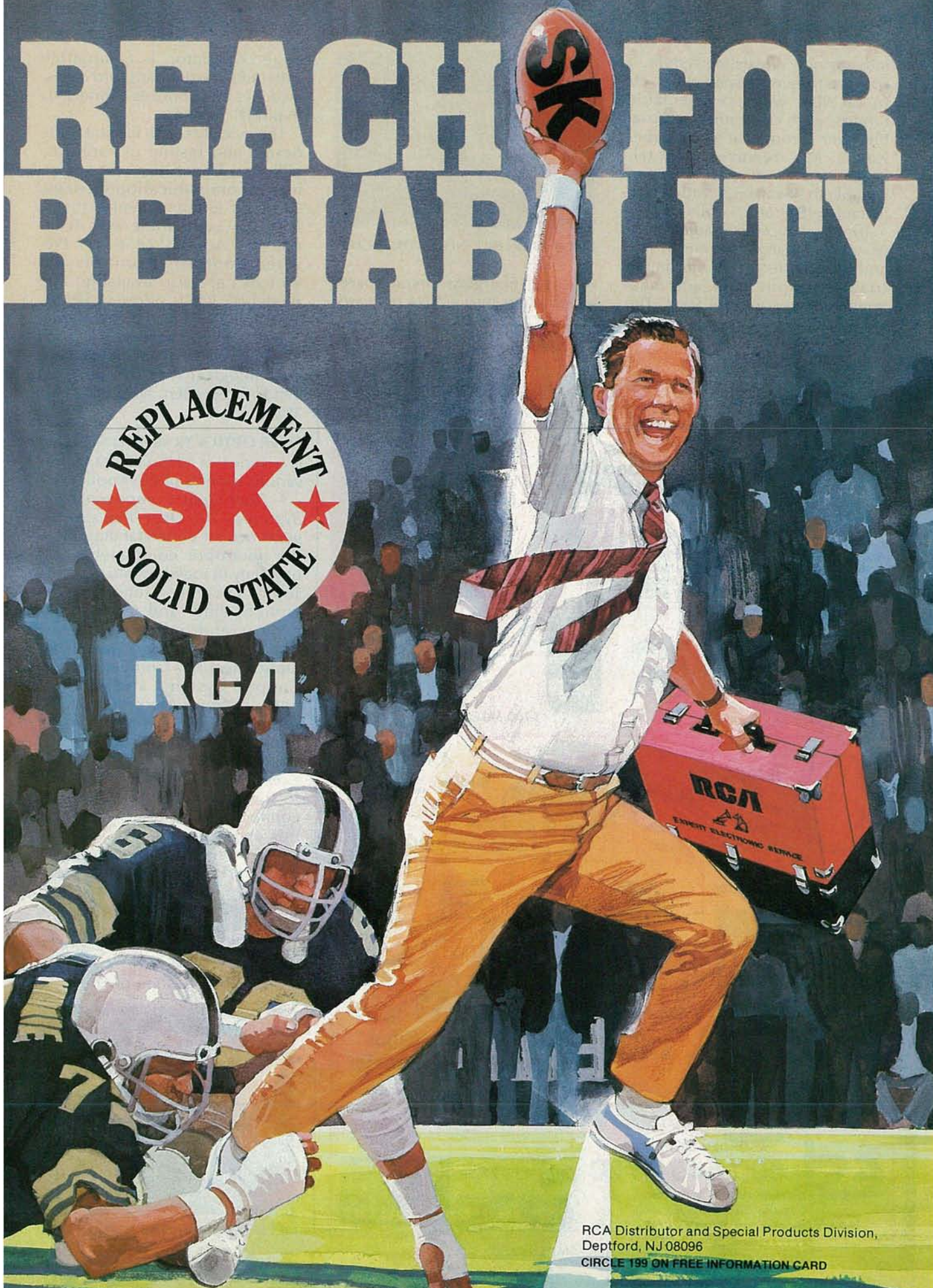

RCA Distributor and Special Products Division,
Deptford, NJ 08096
CIRCLE 199 ON FREE INFORMATION CARD

into any new or existing system. It covers a frequency span of 0.01 Hz to 1.0 MHz with six selectable ranges, each continuously variable over a range of 100:1. Sine-waves, squarewaves, and triangular waves are selectable and variable to 10-volts p-p, with an adjustable offset of ± 5 -volts DC.

Trimmers allow user-adjustment of sine and triangle symmetry, sine and triangle distortion, maximum triangle-output level, and maximum sinewave-output level. The

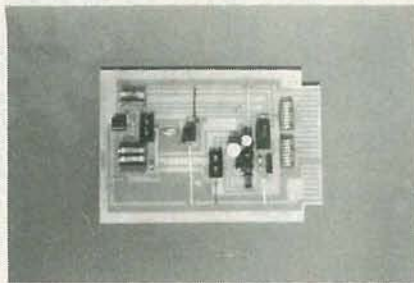

CIRCLE 33 ON FREE INFORMATION CARD

6" x 4.5" fiberglass circuit board, which plugs into a 22/44 pin card-

edge connector, is compatible with industry-standard card cages. Switches and controls connect via 16-pin DIP sockets.

The model *FG 1001* facilitates the design and testing of audio oscillators, bench-top test equipment, communication devices, and laser entertainment systems. It is fully compatible with Technological Artisans' *LASE-BUS*. Pre-wired front-panel controls and switches are also available. The model *FG 1001* is priced at \$89.95, assembled and tested; the model *FGC 001*, front-panel controls with DIP jumpers, is priced at \$39.95.—**Technological Artisans**, 53 West 72nd, Street (3G), New York, NY 10024.

FIBER OPTICS TRAINING SYSTEMS

is a series of VHS videotapes on various aspects of fiber optics.

1. *Fiber Optic Components and Systems—An Overview* gives a good overall understanding of all the fiber-optic components and how they fit together into systems. Topics covered: General Background, Fiber and Cable, Connectors and Splices, Splitters, Light Sources and Receivers, Fiber Optics Testing, Comparisons to Copper, Systems and Applications, Potential Markets, and The Future. This VHS tape with workbook is priced at \$185.00.

2. *How to Install Fiber-Optic Connectors* is a step-by-step guide to the installation of fiber-optic connectors. Included are many tips about potential pitfalls that could otherwise be learned only by experience. Topics covered: Popular Types, Comparisons, Step-by-Step Installation, Tips, Problem Areas, and The Future. This VHS tape with workbook is priced at \$145.00.

3. *Practical Testing of Fiber-Op-*



CIRCLE 35 ON FREE INFORMATION CARD

Desoldering Tool

SALE

\$15⁹⁵ EA.

20 - 240 Volt. 150/60Hz. 25 - 30 Watt. Can be used for both soldering and desoldering. **BM-483**



Video Head VEH 0070

SALE

\$37⁹⁵ EA.

Panasonic type head used in 2-4 hour recorder system. **T-682**



Audiophile Headphone

with Volume Control and Walkman Style Adapter

SALE **\$24⁹⁵** EA.

BM-398

CRT Brightner with Isolation Transformer

T-681 SALE **\$8²⁵** EA.



GE Voltage Suppressor

GESP-753 UL Listed

T-700 SALE **\$15⁹⁵** EA.



Telephone Amplifier

SALE **\$10⁹⁵** EA.

BM-406 Easy Installation



4 Amp Power Supply

SALE **\$18⁷⁵** EA.

BM-231

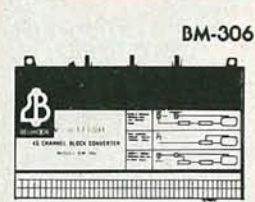

46 Channel Block Converter with Fine Tune Control

SALE **\$19⁹⁵** EA.

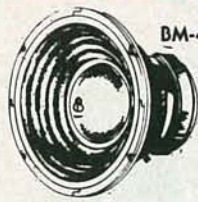

10" Replacement Woofer 8 ohm 35/70 Watt

SALE **\$29⁹⁵** EA.



200 Meg/Ohm Digital Multimeter

AC or DC, w/battery. Display boxed.

BM-317

SALE

\$39⁰⁰ EA.

ESI ORDER BY PHONE
800-645-4720

Electronic Parts & Accessories
a unit of ALPHA-KENCO INC.

3820 14th Avenue, Brooklyn, NY 11218

IN NYS CALL:
(718) 436-9700



call for our free
CATALOG

tic Systems and Components is a real-world guide to testing fiberoptic systems and their individual component parts. Topics covered: Testing Cable, Testing Connectors and Splices, Testing Components, System Testing, Types of Test Equipment, and Troubleshooting. This VHS tape with workbook is priced at \$100.00. All three tapes may be purchased together at \$380.00; extra workbooks are \$10.00 each.—**Radiant Communications Corp.**, 470 Ridgedale Avenue, East Hanover, NJ 07936.

PROGRAMMABLE SCANNER, the model R1075, has 15 channels and can receive more than 15,000 frequencies from six of the most popular public-service bands.

With its priority channel and scan-delay functions, the scanner keeps listeners from missing important transmissions. When it is activated, the priority channel automatically overrides all other calls, so that broadcasts from a favorite channel are never missed. Scan delay puts a two-second



CIRCLE 34 ON FREE INFORMATION CARD

pause at the end of a transmission so that "calls" and "answers" can be heard before the scanner resumes its scanning cycle.

The scanner covers six full bands; VHF-low (30–50 MHz), VHF-amateur (144–148 MHz), VHF-high (148–174 MHz), UHF-amateur (440–450 MHz), UHF (450–470 MHz), and UHF-T (470–512 MHz). A dual scan-speed control allows the scanning cycle to be set to "fast" or "slow" speeds.

The model R1075 has a suggested retail price of \$179.95.—**Regency Electronics, Inc.**, 7707 Records Street, Indianapolis, IN 46226. R-E

Get A Complete Course In

ELECTRONIC ENGINEERING

8 volumes, over 2000 pages, including all necessary math and physics. 29 examinations to help you gauge your personal progress. A truly great learning experience.

Prepare now to take advantage of the growing demand for people able to work at the engineering level.

Ask for our brochure giving complete details of content. Use your free information card number, or write us directly. **\$89.95**, Postage included. Satisfaction guaranteed or money refunded.



**Banner
Technical
Books, Inc.**

1203 Grant Ave.
Rockford, IL 61103

CIRCLE 182 ON FREE INFORMATION CARD



The Super Converter 8001 Features:

- Listening to 810–912 MHz Band on a UHF Scanner and /or Other Monitor Receivers
- Easy Connections to Your Receiver
- 9 Volts Battery Operation Power Source and Power On Indicator by LED Display
- External Power Jack

Warranty

- 180 Days From Date of Purchase

Unit Cost

- \$59.94 plus \$4.00 Shipping and Handling Charge

EASY LISTENING

- FOR 810 TO 912 MHz BAND SUPER CONVERTER 8001
- FOR YOUR UHF SCANNING RECEIVER AND OTHERS

A super-converter 8001 has been certified by FCC part 15 regulation.

HOW TO ORDER

Name: _____

Address: _____

City: _____ State: _____

Zip: _____ Phone () _____

Make Check or Money Order payable to
GRE AMERICA, INC.

Mail to: GRE AMERICA, INC.
425 Harbor Blvd., Belmont, CA 94002

Unit Cost @ \$59.94 × Qty. = Total

CA. Residents Add 6.5% Tax

Shipping & Handling @ \$4.00/
Unit × Qty. =

PAYMENT METHOD TOTAL ▶

Check Money Order
 Mastercard Visa

Card No. _____

Expiration Date _____

Signature _____

**PHONE ORDER: 800-233-5973
or 415-591-1400**

Regency "Scanner Answer" Giveaway



Here's your chance to win a complete monitoring package from Regency Electronics and Lunar Antennas. 18 scanners in all will be awarded, including a grand prize of the set-up you see above: the Regency HX1500 handheld, the Z60 base station scanner, the R806 mobile unit, and a Lunar GDX-4 Broadband monitoring/reference antenna.

55 Channels to go!

When you're on the go, and you need to stay tuned into the action, take along the Regency HX1500. It's got 55 channels, 4 independent scan banks, a top mounted auxiliary scan control, liquid crystal display, rugged die-cast aluminum chassis, covers ten public service bands including aircraft, and, it's keyboard programmable.

Compact Mobile

With today's smaller cars and limited installation space in mind, Regency has developed a new compact mobile scanner, the R806. It's the world's first microprocessor controlled crystal scanner. In addition, the R806 features 8 channels, programmable priority, dual scan speed, and bright LED channel indicators.

Base Station Plus!

Besides covering all the standard public service bands, the Regency Z60 scanner receives FM broadcast, aircraft transmissions, and has a built-in digital quartz clock with an alarm. Other Z60 features include 60

channels, keyboard programming, priority control, digital display and permanent memory.

Lunar Antenna

Also included in the grand prize is a broadband monitoring/reference antenna from Lunar Electronics. The GDX-4 covers 25 to 1300 MHz, and includes a 6 foot tower.



ELECTRONICS INC.
7707 Records Street
Indianapolis, IN 46226

Grand Prize (1 awarded)

- 1—Regency Z60 Base station scanner
- 1—Regency HX1500 Handheld scanner
- 1—Regency R806 Mobile scanner
- 1—Lunar GDX-4 Antenna

First Prize (5 awarded)

- 1—Regency Z60 Base station scanner
- 1—Regency R806 Mobile scanner

Second Prize (5 awarded)

- 1—Regency HX1500 scanner

Contest rules: Just answer the questions on the coupon, (all answers are in the ad copy) fill in your name and address and send the coupon to Regency Electronics, Inc., 7707 Records Street, Indianapolis, IN 46226. Winners will be selected from all correct entries. One entry per person. No purchase necessary. Void where prohibited by law. Contest ends June 30, 1987.

1. The Regency Z60 is
 - a digital alarm clock an FM radio
 - a scanner all of the above
2. The Regency R806 is the world's first _____ controlled crystal scanner.
3. The Regency HX1500 features
 - 55 channels Bank scanning
 - Liquid crystal display all of the above
4. The Lunar GDX-4 antenna covers _____ to _____ MHz.

Name: _____

Address: _____

City: _____ State: _____ Zipcode: _____

I currently own _____ scanners.

Brands owned: _____



Send in a photo (like this one of Mike Nikolich and his Regency monitoring station) and receive a free gift from Regency. Be sure to include your name, address and phone number.

BUILD THIS



TOD T. TEMPLIN

STEREO TV DECODER

Build your own high-fidelity MTS decoder for the finest in TV enjoyment.

A RECENT SURVEY OF TELEVISION STATIONS across the U. S. and Canada reveals that more than 250 stations are now transmitting MTS stereo TV sound. So chances are good that at least one station in your area is transmitting stereo audio right now. You might think that you need a stereo TV or VCR to enjoy MTS, but consider this: For about \$50 (for all new parts), you can build our add-on converter, which will work with virtually any TV or VCR. All components are readily available, and we've designed a PC board, which simplifies construction greatly. The circuit may be aligned by ear, although using an oscilloscope will give more precise results.

Background

To understand how we can enjoy MTS sound, let's look back to when color-TV standards were formed. In 1953 the NTSC (National Television Systems Committee) defined the standards for color-TV broadcasting that are now used in the U. S., Canada, Mexico, and Japan.

In the NTSC system, 6 MHz is allocated for each television channel, as shown in Fig. 1. Video information is transmitted on an amplitude-modulated carrier that extends about 4.2 MHz above the visual carrier. Mono audio is transmitted on a frequency-modulated carrier 4.5 MHz above the video carrier, with 100% modulation causing a 25-kHz deviation of that carrier. So a fully modulated mono signal causes the carrier to vary between 4.475 and 4.525 MHz around the carrier.

By subtracting 4.2 MHz (top of video) from 4.475 MHz (bottom of audio), we find that there is 275 kHz of unused spectrum. That space was originally allocated as a guard band by the NTSC. The reason the guard band was necessary was that the tube-based circuits of that era were less

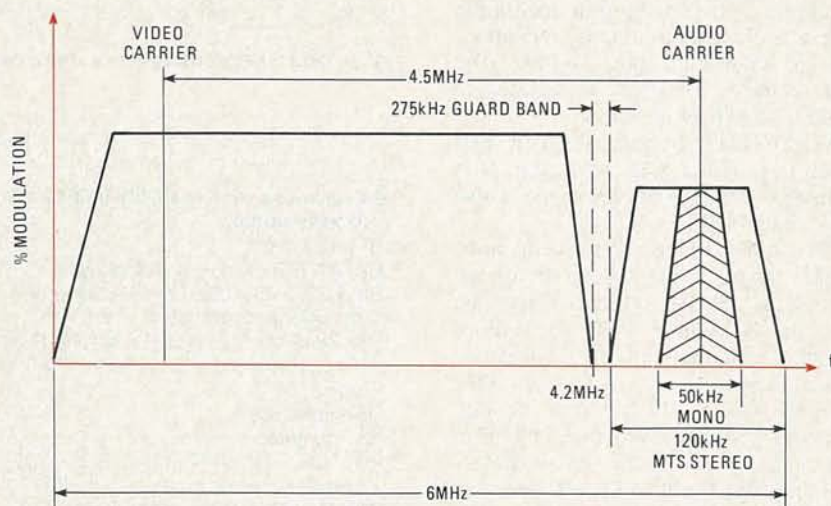

FIG. 1—STEREO-TV AUDIO requires about twice the bandwidth of a mono signal.

capable of keeping the audio and the video portions of the signal separate than modern solid-state circuits. It is that 275-kHz gap that allows us to have MTS sound today.

On March 29, 1984, the BTSC (the Broadcast Television Standards Committee, which is the present-day equivalent of the NTSC), proposed guidelines to the FCC (in BC docket 21323) for TV stations using the BTSC system of multichannel sound transmission. That docket contains general technical rules governing the use of the television audio baseband for use in the transmission of stereo television sound, as well as a second-language channel (SAP, for Second Audio Program), and a professional channel. (The alternate services were discussed in "Stereo Audio for TV," *Radio-Electronics*, February and March 1985, and in "Stereo TV Decoder," in the March 1986 issue of *Radio-Electronics*.—*Editor*)

As in the NTSC system, the baseband mono audio signal (which is the equivalent of the L+R stereo signal) has a bandwidth of about 15 kHz. It is transmitted with 75 μ s of pre-emphasis, and has a maximum deviation of 25 kHz.

At 15.734 kHz is the BTSC pilot tone. The pilot is locked to horizontal sync, and it is used to identify the signal as a BTSC transmission, thus informing the television receiver to switch from mono to stereo reception. The pilot has a 5-kHz deviation.

Then comes the stereo difference signal (L-R). It is amplitude modulated on a 31.468 kHz subcarrier, producing a double-sideband suppressed-carrier signal that spans about 30 kHz. That subcarrier frequency was chosen because it is exactly twice the NTSC horizontal sweep frequency, and is, therefore, easily synchronized during both transmission and reception.

NOISE REDUCTION

THE STEREO DECODER DESCRIBED IN THIS article doesn't use a true dbx decoder. When we first decided to build an MTS decoder, we contacted the engineers at dbx Corporation in an attempt to obtain engineering samples of their decoder IC's. As you may know, however, dbx Corporation does not sell those IC's to unlicensed persons or companies, and that includes hobbyists. We were discouraged, but decided to go ahead and build a converter without the dbx IC's, and see just how well it could be done.

The decoder presented here is the result of that effort, and we believe that it performs as well as many commercial units. In addition, none of the electronic components used are difficult to obtain. Also, due to a very flexible design, you can interface the decoder to almost any TV or VCR and obtain very good results. **R-E**

The L-R signal is also compressed by a complex noise-reduction technique known as dbx television noise reduction. (See the sidebar for more on dbx.) The level of the L-R signal is adjusted to produce 50 kHz of deviation.

At 78.67 kHz (five times the horizontal sweep rate) is the SAP subcarrier. It is limited to 10-kHz of deviation and is also dbx compressed.

Last, at 102.3 kHz (6.5 times the horizontal sweep), is the subcarrier for the professional channel. It is not compressed and is limited to about 3-kHz of deviation.

If the deviations of all sub-channels are added together, the total is 98 kHz (25 + 5 + 50 + 15 + 3). However, the total deviation is not allowed to exceed 73 kHz (50 + 15 + 3), because the sum of the deviations of the L + R and L - R signals is limited to 50 kHz. Although that total is greater than the deviation of a plain mono transmission, it fits into the guard band with room to spare.

If you're familiar with the stereo system used for FM radio transmissions, you'll notice that the stereo portion of the BTSC system is essentially the same as that used in FM radio, disregarding the SAP and professional channels. In fact, the main differences are the slightly different frequencies of the pilot and the L-R subcarriers. We can take advantage of those similarities by using an IC that is normally used to decode FM radio signals. Doing so simplifies our design and reduces costs considerably.

The circuit

A block diagram of the stereo-TV decoder is shown in Fig. 2. It shows the overall relationships between the separate sections of the circuit. Figures 3-6 show the details of each subsection.

Let's start with the decoder section (shown in Fig. 3). It centers around IC1, a

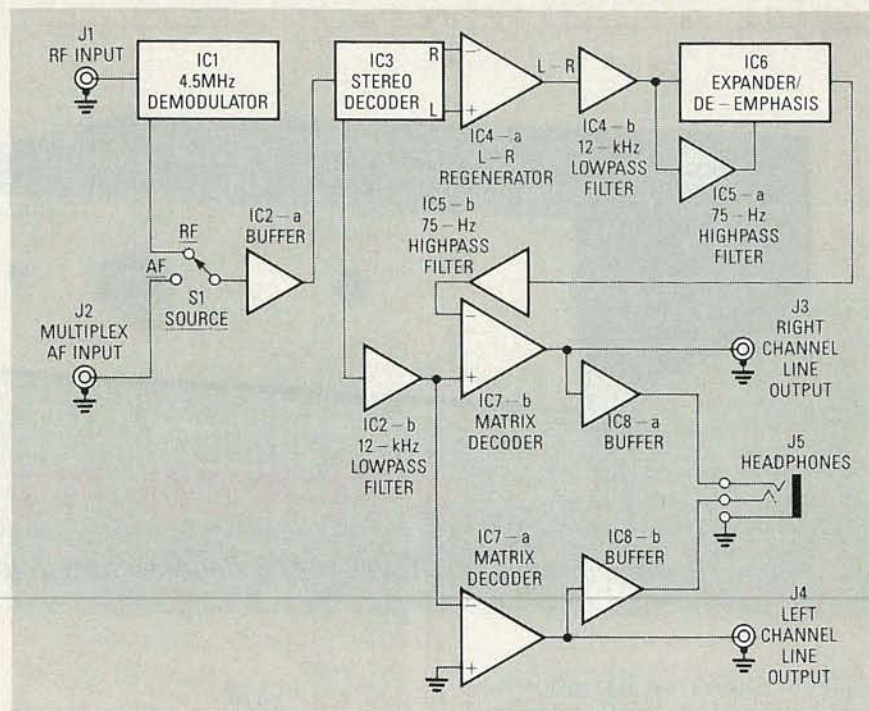

FIG. 2—EIGHT INEXPENSIVE IC'S are all it takes to provide a high-quality MTS decoder.

PARTS LIST

All resistors are 1/4-watt, 5% unless otherwise noted.

R1—120 ohms
 R2, R7, R35, R37—10,000 ohms
 R3, R23, R49, R53, R54—10,000 ohms, trimmer potentiometer
 R4, R6, R11, R12, R42, R43, R44, R46, R48, R50, R51, R59, R60—100,000 ohms
 R5—2200 ohms
 R8—10 ohms
 R9, R24, R31, R57, R58, R63—1000 ohms
 R10, R16, R17, R28—3300 ohms
 R13—330,000 ohms
 R14, R15, R21, R62—4700 ohms
 R18—12,000 ohms
 R19—25,000 ohms, trimmer potentiometer
 R20—4300 ohms
 R22, R27—5100 ohms
 R25—5,000 ohms, trimmer potentiometer
 R26—1500 ohms
 R29—30,000 ohms
 R30—18,000 ohms
 R32, R33, R39, R40—20,000 ohms
 R34, R41, R55, R56—39,000 ohms
 R36, R38—22,000 ohms
 R45—68,000 ohms
 R47—470,000 ohms
 R52—100,000 ohms, dual-gang potentiometer
 R61—330 ohms

Capacitors

C1, C4, C13, C32—0.01 μ F, ceramic disk
 C2, C9, C19—470 pF, ceramic disk
 C3, C14—0.05 μ F, ceramic disk
 C5—5-60 pF, trimmer
 C6—10 pF, ceramic disk

C7, C8, C10, C11, C27, C38, C47—1 μ F, 50 volts, electrolytic
 C12, C23, C25—0.0022 μ F, ceramic disk
 C15, C30, C34-C37—0.22 μ F, ceramic disk
 C16, C17—0.47 μ F, ceramic disk
 C18—0.0047 μ F, ceramic disk
 C20, C21—0.0015 μ F, ceramic disk
 C22, C24—0.0039 μ F, ceramic disk
 C26, C29—0.015 μ F, ceramic disk
 C28, C31, C39-C46—10 μ F, 50 volts, electrolytic
 C33, C50-C53—2.2 μ F, 50 volts, electrolytic
 C48—2200 μ F, 50 volts, electrolytic
 C49—470 μ F, 50 volts, electrolytic

Semiconductors

IC1—MC1358 stereo demodulator
 IC2, IC4, IC5, IC7, IC8—LM358 dual op-amp
 IC3—LM1800 stereo decoder
 IC6—NE570 compander
 D1, D1—1N4002 rectifier diode
 LED1, LED2—standard
 Q1, Q3—2N3904 NPN transistor
 Q2—2N3906 PNP transistor
 Q4—2N2222 NPN transistor

Other components

F1—1/4-amp, 250-volt fuse
 J1-J4—RCA phono jack
 J5—stereo headphone jack
 L1—33 μ H S1—SPDT toggle switch
 S2—SPST toggle switch
 T1—10.7 MHz IF transformer
 T2—25-volt CT power transformer

Note: A drilled, etched, and plated PC board is available from Tod. T. Templin, 5329 N. Navajo Ave., Glendale, WI 53217 for \$9.00.

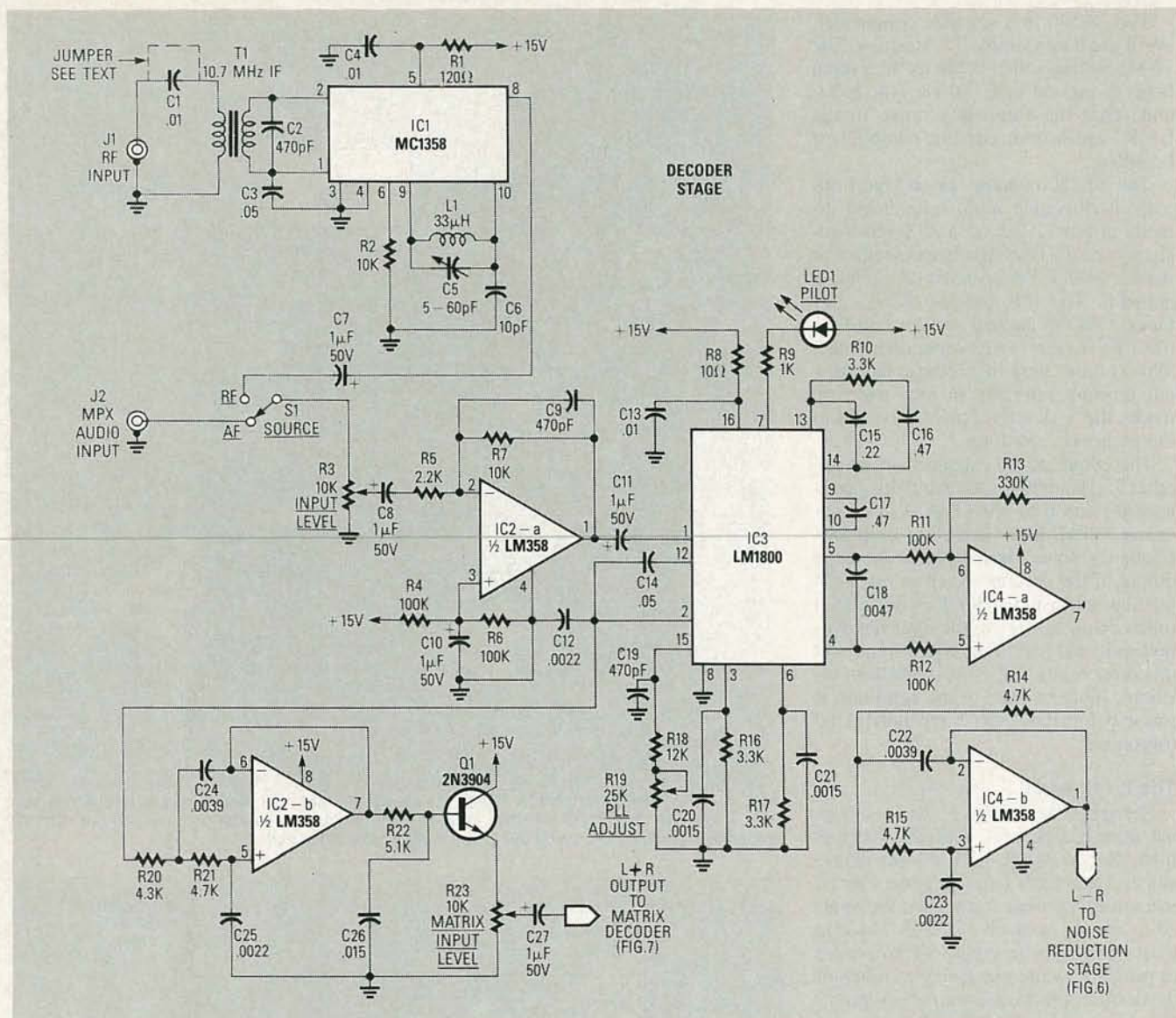

FIG. 3—THE DECODER STAGE converts the multiplexed audio signal into L + R and L - R signals.

standard 4.5-MHz audio demodulator that is used in many television receivers. The circuit is more or less what you find in the databook. The major exception is that the standard de-emphasis capacitor has been eliminated in order to ensure that the L - R signal is presented to the decoder. If present, the capacitor would roll off the high-frequency L - R signal.

The output of IC1 is routed to S1, which allows you to choose between the internally demodulated signal and an externally demodulated one. Buffer amplifier IC2-a then provides a low-impedance source for driving IC3, an LM1800 stereo demodulator. As with IC1, IC3 is used in a conventional manner. Our circuit differs from the cookbook circuit, however, in that the component values associated with the phase-locked loop have been altered so that the loop will lock on the 15.734-kHz MTS pilot rather than on the 19-kHz FM-radio pilot.

When IC3 is locked on a stereo signal,

the outputs presented at pins 4 and 5 are the discrete left- and right-channel signals, respectively. In order to provide noise reduction to the L - R signal, we must re-combine the discrete outputs into sum and difference signals. Op-amp IC4-a is used to regenerate the L - R signal. It is wired as a difference amplifier, wherein the inputs are summed together (+L - R). Capacitor C18 bridges the left- and right-channel outputs of the demodulator. Although it decreases high-frequency separation slightly, it also reduces high-frequency distortion. After building the circuit, you may want to compare sound output with and without C18.

The L + R signal is taken from the LM1800 at pin 2, where it appears conveniently at the output of an internal buffer amplifier.

The raw L - R signal is applied to IC4-b, a 12-kHz lowpass filter. The L + R signal is also fed through a 12-kHz lowpass filter in order to keep the phase shift un-

dergone by both signals equal. If only one were filtered, there would be a loss of high-frequency separation when the left and right channel signals were recovered.

Next, as shown in Fig. 4, the L - R signal is fed to Q2. That transistor has three functions. It allows us to add a level control to the L - R signal path; it provides a low source impedance for driving the following circuits; and it inverts the signal 180°. (Think of the signal at the collector of Q2 as -(L - R)). Inversion is necessary to compensate for the 180° inversion in the compander.

Next comes the expander stage; this is where we would use a dbx decoder if we could get one (see sidebar). At the collector of Q2 is a 75- μ s de-emphasis network (R27 and C29) that functions just like the network associated with Q1 (in Fig. 3). Note that Q2 feeds both Q3 and IC5-a, a -12 db per octave highpass filter. The output of that filter drives the rectifier input of IC6, an NE570.

The NE570 is a versatile compander. We'll use it as a simple 2:1 expander. The 75-Hz highpass filter at the rectifier input helps to prevent hum, 60-Hz sync buzz, and other low-frequency noise in the L-R signal from causing pumping or breathing.

The NE570 contains an on-board op-amp; its inverting input is available directly at pin 5, and via a 20K series resistor at pin 6. That's a convenient place to implement the 390- μ s fixed de-emphasis network. The 18K resistor (R30) combines with the internal resistor and C32 (0.01 μ F) to form a first-order filter with a 390- μ s time constant. Because the internal op-amp operates in the inverting mode, the -(L-R) signal is restored to the proper (L-R) form.

The output of the expander drives another 75-Hz highpass filter, but this one is a third-order type providing -18 db per octave rolloff. It too is used to keep low-frequency noise from showing up at the output of the decoder. Keep in mind the fact that television audio does not extend much below 50 Hz, so the filter removes no significant part of the audio signal. At this point the (L-R) signal has been restored, more or less, to the condition it was in before it was dbx companded at the transmitter.

The L + R signal

Referring back to Fig. 3, the L + R signal from IC3 is fed to a 12-kHz lowpass filter, IC2-b, with a -12 dB per octave slope. That cutoff frequency was chosen in a somewhat arbitrary manner. We wanted to remove as much of the 15.734-kHz pilot signal from the output of the decoder as possible, while preserving as much of the desired high-frequency audio as possible. So we settled on 12 kHz as a good compromise.

The output of the highpass filter is applied to a 75- μ s de-emphasis network (R22 and C26). The L + R audio signal is now restored properly. We feed it through Q1, which is wired as an emitter follower to provide a high load impedance for the de-emphasis network and a low source impedance for level control R23. Next the L + R signal is fed to the matrix decoder, shown in Fig. 5.

Left and right recovery

Op-amps IC7-a and IC7-b are used to recover the individual channels. First, IC7-b is configured as unity-gain difference amplifier. The (L + R) is applied to its inverting input, and the (L - R) signal is applied to the non-inverting input. Therefore the output of IC7-b may be expressed as $-(L + R) + (L - R) = -L + L - R - R = -2R$. Similarly, IC7-a is configured as a mixing inverting amplifier. Here, however, both sum and difference signals are applied to the inverting input. So the output of IC7-a is $-(L + R)$

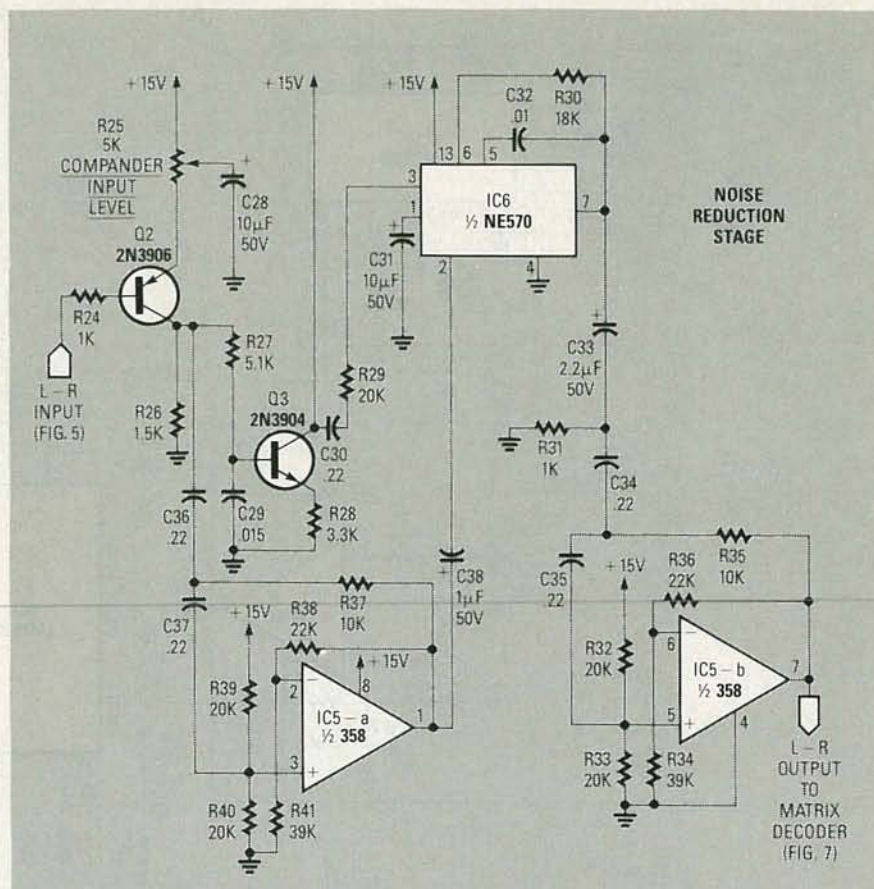

FIG. 4—THE NOISE-REDUCTION STAGE de-compands the L-R signal, and emulates dbx-style processing. As described elsewhere in this article (see box), true dbx processing is not currently possible in a home-built circuit due to the inavailability of the dbx IC's.

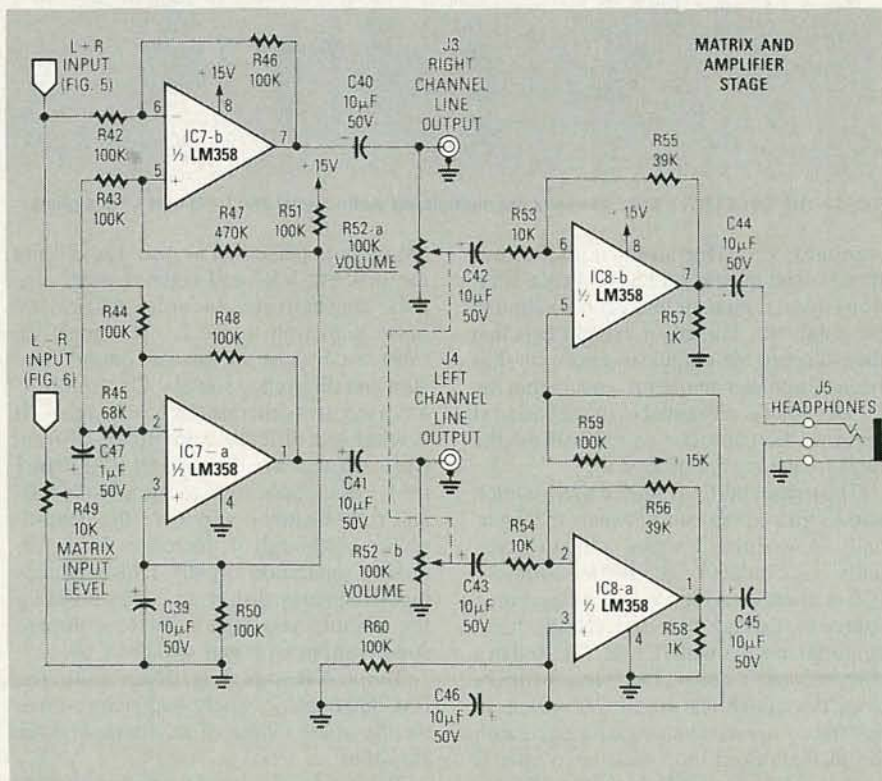

FIG. 5—THE MATRIX STAGE separates the L + R and L - R signals into the left- and right-channel components. Op-amp IC8 and associated components provide an optional headphone output. If you do not wish to drive a pair of headphones, or plan to use your amplifier's headphone jack for that purpose, all components to the right of jacks J3 and J4 can be deleted.

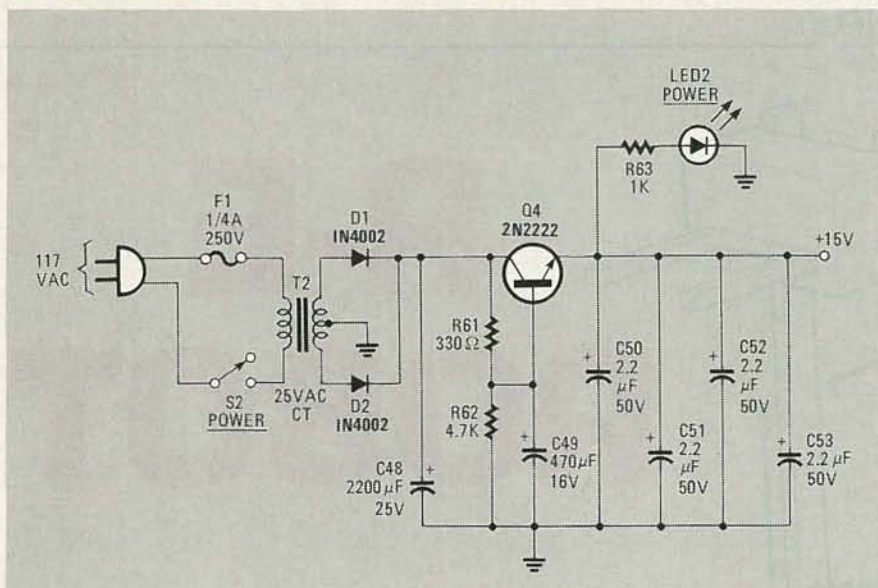

FIG. 6—THE UNREGULATED POWER SUPPLY shown here provides extremely low ripple for the MTS decoder.

COMPENSATION

THE MARCH 1985 ISSUE OF **RADIO-ELECTRONICS** has a good description of the dbx system, but we'll summarize the salient features here. Keep in mind the fact that dbx operates only on the stereo difference signal (L-R).

- The signal is compressed at transmission by a fixed ratio of 2 to 1.
- The signal is pre-emphasized by a combination of 75- μ s and 390 μ s networks.
- The signal is spectrally companded by a variable ratio that depends on broadband frequency balance and signal level.

Of those three functions, spectral companding is the most difficult to compensate for. We include de-compression circuits and the proper de-emphasis networks, but we decided not to include spectral de-companding in our decoder, based on the following rationale.

Spectral companding's primary function is to mask high-frequency noise when the signal is composed primarily of low frequencies at relatively low levels. It does so by adding a variable amount of high-frequency pre-emphasis at the proper times. If the signal contains relatively high signal levels across the entire audio spectrum, little spectral companding is performed. Fortunately, in the real world of television broadcasting, high-level signals that extend across the entire audio spectrum are fairly common, so little dbx companding actually is performed.

All television stations use sophisticated audio processing devices to boost the audio level during quiet program material, and to limit the level during loud material (like commercials). Those devices generally divide the spectrum into three bands, and each band is independently monitored by the processor to ensure that the levels in each band remain relatively high.

The end result is that overall modulation remains high across the entire audio spectrum for most types of program material. Therefore, the dbx circuitry would do little spectral companding, so we made no attempt to compensate. **R-E**

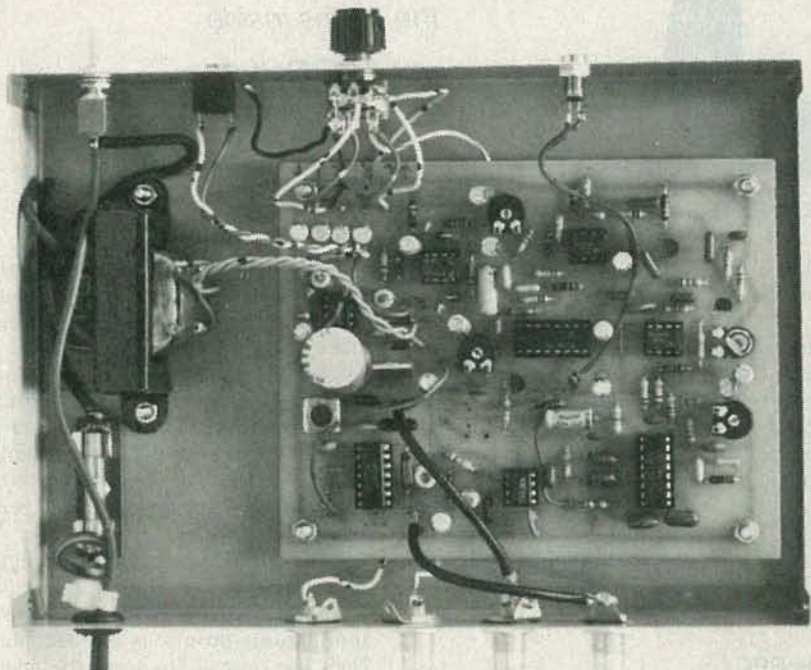

FIG. 7—THE COMPLETED STEREO DECODER BOARD. Next time, we'll show you how to build the circuit shown here.

$-(L-R) = -L - R - L + R = -2L$. Because both channels have been inverted, the stereo relationship is preserved.

The two op-amps in IC8 provide an additional stage of amplification to drive a pair of stereo headphones. If you don't plan to use headphones, or if you are content to use only your stereo's headphone jack, all components to the right of line-output jacks J3 and J4 may be deleted.

The schematic of the decoder's power supply is shown in Fig. 6. It provides an unregulated 15-volt DC output. Transistor Q4 is used as a capacitance multiplier, to

provide high ripple reduction. The four 2.2- μ F capacitors (C50-C53) are distributed on the PC board (which we'll show next time) to keep the impedance of the power-supply rails low. That's important to minimize crosstalk between different sections of the unit.

As shown in Fig. 7, most of the circuitry we've described mounts on a single PC board. Unfortunately, we've run out of space for this month. When we continue we will show you how to build the circuit, as well as several methods of connecting the unit to a TV or VCR. At that time, the PC pattern will be provided. If you wish to get a head start, and are planning to purchase a pre-etched board, you can order one from the source provided in the Parts List. **R-E**



AN OUTBOARD TUNER lets you use the circuit with a TV that lacks audio outputs. Next time, we'll see many other ways of using the circuit.

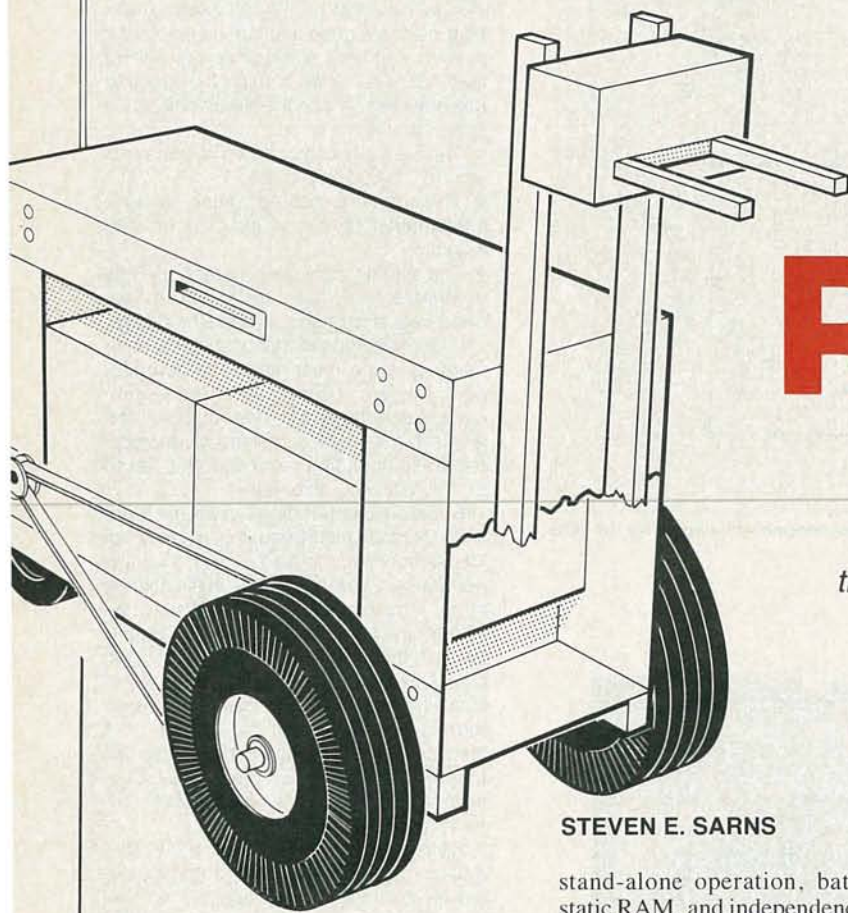

R-E ROBOT

*A detailed look at
the Robotic Personal Computer—
the brains inside
the R-E Robot.*

STEVEN E. SARNS

Part 2 OUR LAST ARTICLE introduced you to the R-E Robot, and to our project to provide a sophisticated, yet low-cost, alternative to the expensive home robot. This month, we will look a little more closely at the Robotic Personal Computer (RPC). The development of the RPC represented quite a challenge, but produced an exciting single-board personal computer that can be interfaced with a wide range of off-the-shelf or custom peripherals.

Design criteria

Most of our work to this point had used the SBC88 (a single-board controller project described in the April through June, 1984 issues of *Radio-Electronics*). However, we realized that that single-board controller with its on-board inputs and outputs was too limited to use for our robot project. That applied both to the controller's input/output capability and to the programming environment that it provided. We knew what we needed—the productive programming environment of a personal computer combined with the economy and ruggedness of a single-board controller. Typical single-board computer features that add to that ruggedness include application code in ROM,

stand-alone operation, battery-backed static RAM, and independence from troublesome disk drives once the application programming is completed. However, we needed the PC bus for possible future memory and input/output expansion of the robot. With so many ideas and possibilities revolving around our robot, we did not want the hardware to limit us.

After a careful search, we found that a single-board computer that met all of our requirements was not available. Our task then was to design such a computer, and to do it on a spartan budget.

The RPC

The Robotic Personal Computer (RPC) was designed to bridge the gap between the single-board controllers and the personal computer. Both types of machines have advantages and disadvantages. The controller is the classic solution to problems for which microprocessor control is required. However, the productive programming environment and the rapidly declining price of the personal computer are now tempting many manufacturers to incorporate complete personal computers into their products.

It takes a major commitment of money and talent to design a single-board computer for dedicated control applications. Such a project requires a development system because the completed single-

board computer has no operator interface. Typically, development systems cost between \$5000 and \$30,000 and require engineers to design the hardware and programmers to develop the software in assembly code. Once completed, however, the manufacturer has an economical system that is custom-tailored to his application. All software is stored in ROM, the most secure and least expensive form of data storage.

The personal computer offers an alternative to the foregoing for situations where disk-based operating systems and applications programs are acceptable. Their use nearly eliminates the need for the services of design engineers, because all that may be required in the way of hardware design is a peripheral board, and then only when a standard off-the-shelf product cannot be located.

There are some disadvantages to using a personal computer in a dedicated control application. The major one is that they store their code on disk. Many dedicated control applications require that the computer exist in harsh environments where disk drives cannot function reliably. Another problem is the operator interface. The personal-computer interface has been optimized for the programmer or data-entry person. However, many control applications require highly customized operator interfaces, such as LCD or touch-

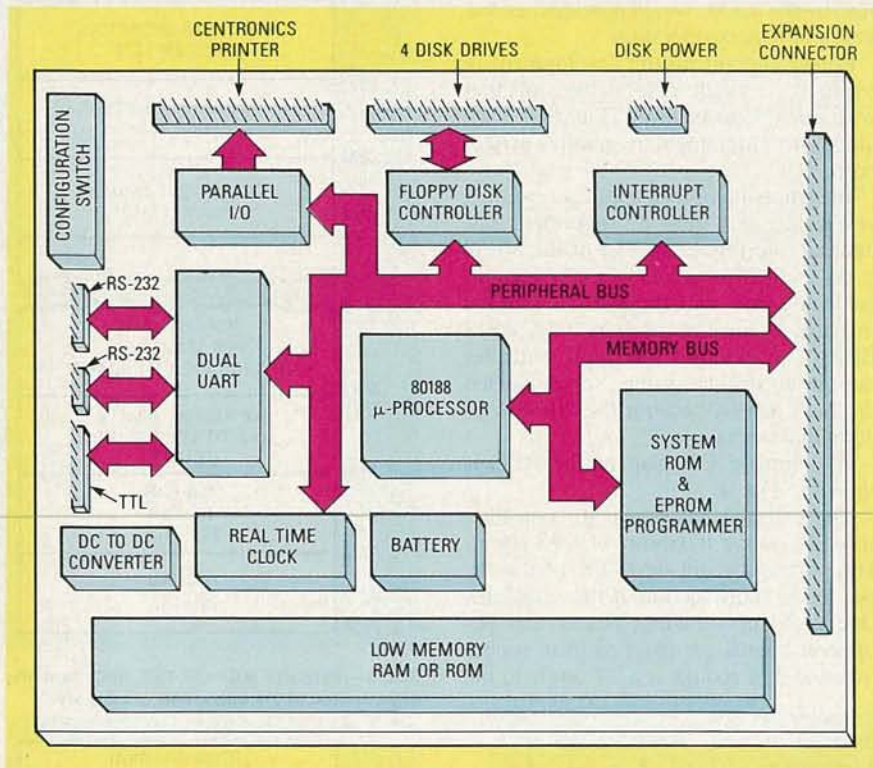

FIG. 1—BLOCK DIAGRAM OF THE RPC. All major functions of the computer are shown here.

panel displays. Finally, and most important, the end product is much more expensive than necessary.

With all that in mind, we set out to design our RPC, a single-board personal computer. Our design requirements dictated that the result would be a unique product. The major requirements were:

- The system must be its own development system (like a personal computer).
- The system must be tailored (both in hardware and in software) to execute ROM-based programs.
- The system must have a readily accessible expansion bus.
- The system must be economical at the board level, containing only those components needed to implement the design goals (like a single-board computer).

Once the design specifications were clear, we drew up some block diagrams. The trick was to achieve a balance between all the goodies that could be tied into the system, while preserving economy of board space and component cost. Before long, the design shown in Fig. 1 began to take shape. And after several months of sketching, the first schematics emerged. A complete schematic of the final version of the RPC will be shown in a future installment.

Designing the hardware

Once we knew the overall design of the RPC, we were faced the task of selecting

the components. The first step was choosing the microprocessor. Given the success of the IBM PC, our first thought, naturally, was to use the 8088. That microprocessor is supported by the latest generation of software packages available. However, the 8088 requires a large number of support IC's. The newer 80188 is a highly integrated version of the 8088. Much of the peripheral support circuitry required by the 8088 has been included on the 80188 chip (see Fig. 2). That high degree of integration also made it easier to meet our goal of a physically small circuit board.

Although dynamic RAM is less expensive than static RAM, there are several advantages in using static RAM for the RPC. During the applications-software development process, RAM can be replaced with programmed EPROM's as the program is developed. An EPROM programmer is included on the board. That EPROM programmer also programs EEPROM's, which is handy when you consider that some applications software will probably need to be developed in the field. An on-board battery keeps the RAM powered for several months. One of the disadvantages of static RAM is the package size. Provision for special two-high RAM-stacking sockets is included. Those sockets accommodate up to 128K of RAM/EPROM memory.

Upper memory, normally the domain

of the Basic Input Output System (BIOS) and system monitor, if present, has received special attention. An entire 64K segment is allocated to 4 byte-wide sockets. The highest 16K contains the BIOS and power-on reset vector. Two more sockets contain 32K of high-level language and applications code. The fourth socket is either the EPROM programmer or contains applications code. A complete memory map is shown in Fig. 3.

The system must support a disk drive during program development for program storage and retrieval. (The disk drive, however, must not be required in the final target system. System software must be ROM based and tailored to ROM-based applications programs.) The disk drive is invaluable when large amounts of data must be stored. Disk-drive support there-

Can you imagine what a robot we could build with a staff of 250,000 (the entire readership of **Radio-Electronics**)? One key to the success of the **R-E Robot** is the collective development capability of that readership. In an effort to encourage the exchange of programs, sources of parts, hardware enhancements, and any other items of general interest, **Radio-Electronics**, Stock Drive Products, and Vesta Technology are each offering special support.

Radio-Electronics will open a special section of its new remote bulletin board system (RE-BBS) to builders of the **R-E robot**. You can reach the bulletin board by calling 516-293-2283.

Stock Drive Products (55 S. Denton Ave., New Hyde Park, NY 11040 516-328-0200) has agreed to supply a kit of parts for the drive sub-system, including two 10-inch pulleys and two 2-inch pulleys. Part number 2Z6-RL11862 is available for \$32.00.

To simplify the mechanical aspects of building a robot, Vesta will sell, for a limited time, an aluminum chassis (resembling the one in Fig. 1) at cost, approximately \$45. The fully-populated RPC will be available for \$294, including 16K of RAM and the FORTH operating system. The Board-1 PC board is available as a bare board for \$41, or fully assembled for \$289. All source code for testing the robot and implementing RCL is available on a 5.25-inch disk for \$2.00. All Vesta products are covered by a 15-day return policy. MasterCard or Visa accepted; no purchase orders or terms available. Please add \$8.00 for shipping and handling for the computer board. Vesta Technology, Inc., 7100 W. 44th Avenue, Suite 101, Wheatridge, CO 80033, 303-422-8088.

Additional sources for various parts and sub-systems will be listed in future installments of this article.

R-E

fore is included on the board. The Western Digital WD1770 single-IC floppy-disk controller supports both 5.25" and 3.5" drives. The preferred drive is the latest Citizen 3.5" model; it offers two important advantages: 1" overall height and 5-volt DC operation (no other supply voltages are required).

A terminal was selected as the programmer interface for program development. The variety of terminals available ranges from a computer system emulating a terminal to a battery-operated handheld unit. The terminal can be removed if it is not required by the application. Of course, the RPC must have a UART to drive the terminal. The Signetics SCN2681 was selected. That dual UART is supplied in a 28-pin package, an important consideration when trying to minimize board size. The second UART channel has selectable RS-232 or direct TTL I/O. That allows direct connection to inexpensive board-level modems or other serial data-interface units. RS-232 voltage-levels are generated on-board with a small DC-DC converter.

Most control and data-acquisition applications require time-of-day informa-

tion, a function also included on the board. The National MM58274 real-time clock IC is supported by the same battery used by the RAM, which provides several weeks of battery operation.

Printer support during development is required. A single octal driver, together with a few leftover gates is all that is required to implement a parallel-printer port.

Interrupts in control applications are a key feature that must be supported. The internal interrupt-controller of the 80188 is not as flexible as an external interrupt-controller, nor will the 80188's internal interrupt-controller support a PC-DOS BIOS. An external interrupt-controller must be used in the system, so we selected the Intel 8259A because the 80188 supports that device.

A complete I/O map of the RPC is shown in Fig. 4.

The external bus-connector considerably affects the flexibility of the system. The popularity and flexibility of the PC bus led to the selection of that standard. One problem with that bus is that peripheral boards are plugged-in in such a way that they mount at a 90° angle to the

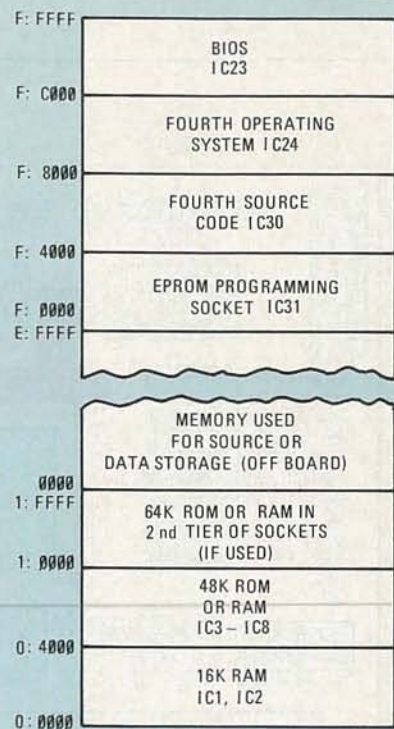

FIG. 3—MEMORY MAP OF THE RPC. Note the organization of the upper 64K of memory.

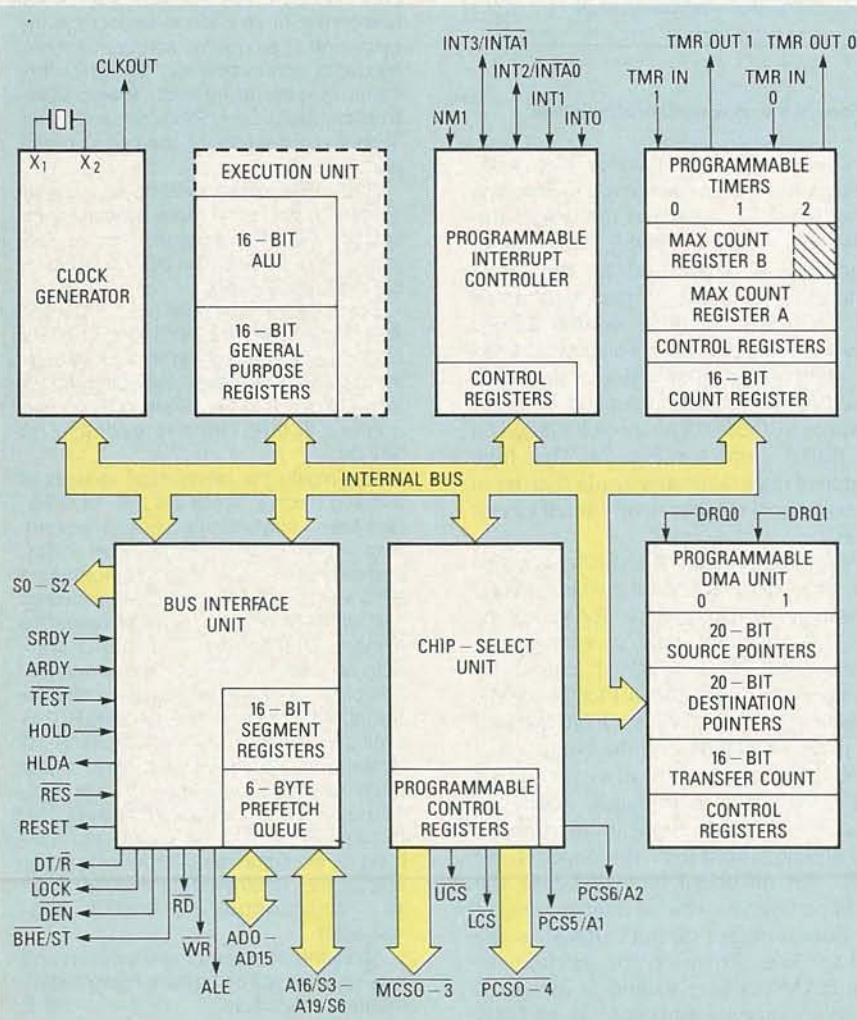

FIG. 2—THE 80188 MICROPROCESSOR was selected for our project because of its compatibility with the 8088 and its high degree of integration.

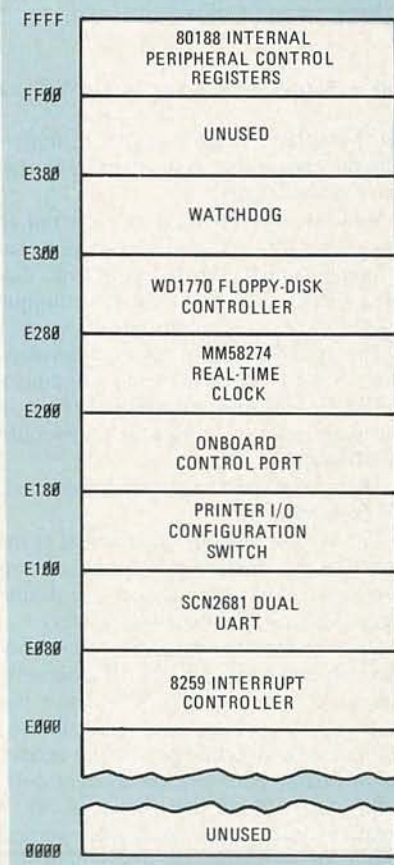

FIG. 4—THE RPC'S I/O SYSTEM organization is detailed here.

motherboard. Such an arrangement posed significant packaging problems. To elimi-

continued on page 69

Make your home into something special!

That's exactly what your home will be when you fill it with Heathkit electronic products — products that make your life easier and more enjoyable. Within our diverse line are kit and assembled products sure to enhance each room in your home.

1. Make your entryway more secure and easy to use with the Keyless Doorlock. You'll never again be locked out because of lost or forgotten keys. All it takes is a simple fingertip entry of a four-digit code, and the Keyless Doorlock unlocks your door.

2. Add a new dimension to your living room with your own Computerized Weather Station. This Digital Weather Station displays up-to-the-minute temperature, wind, and barometric pressure readings, along with time and date.

3. Give your kitchen a unique blend of style and efficiency with our Digital Wall Clock. This easy-to-build kit keeps time with quartz-crystal accuracy. And with its simulated oak wood-grain finish cabinet, you'll have a timepiece that fits into almost any decor.

4. Put your den to greater use with this IBM PC AT Compatible Computer. Do word processing, personal accounting and more when you run exciting IBM-compatible software on your fast and powerful HS-241. And you can build it yourself in just a few hours.

5. Bring the latest in digital technology to your bathroom. This Digital Scale lets you closely monitor your weight with electronic precision. And, it's battery operated so it's safe to use right out of the shower.

6. Add a video entertainment center to your bedroom. Our 19"-diagonal stereo TV kit gives you an extra-sharp color-corrected picture with full stereo sound, and convenient viewing that you can control from your bed. Comes in a simulated walnut cabinet that complements your room.

7. Transform your rec room into a haven for hobby fun. Put our Deluxe QRP CW Transceiver in this room and enjoy superb HAM radio operation that excels in performance and features. It offers expandable transmission and reception capabilities.

8. Give your workbench a touch of professionalism with this oscilloscope. Whether you're a service technician or a hobbyist, you'll love the wide range of measurement capability our laboratory-grade Dual Trace 10 MHz Oscilloscope gives you.

9. Add practicality to the utility room and save money, too. Avoid expensive food spoilage with our Freezer Alarm that

warns you when the inside temperature of your freezer rises too high. Prevent water damage with our Food Alarm that warns you of water that's where it shouldn't be.

10. Make your coming and going easier than ever. Your garage door will open with incredible ease and dependability with our Deluxe Garage Door Opener. Easy to install, this opener is durable and includes a handy security light.

You'll find fun and excitement with every Heathkit product. Whether they're in kit form or already assembled, our products will help you enjoy your home more than you ever dreamed possible.

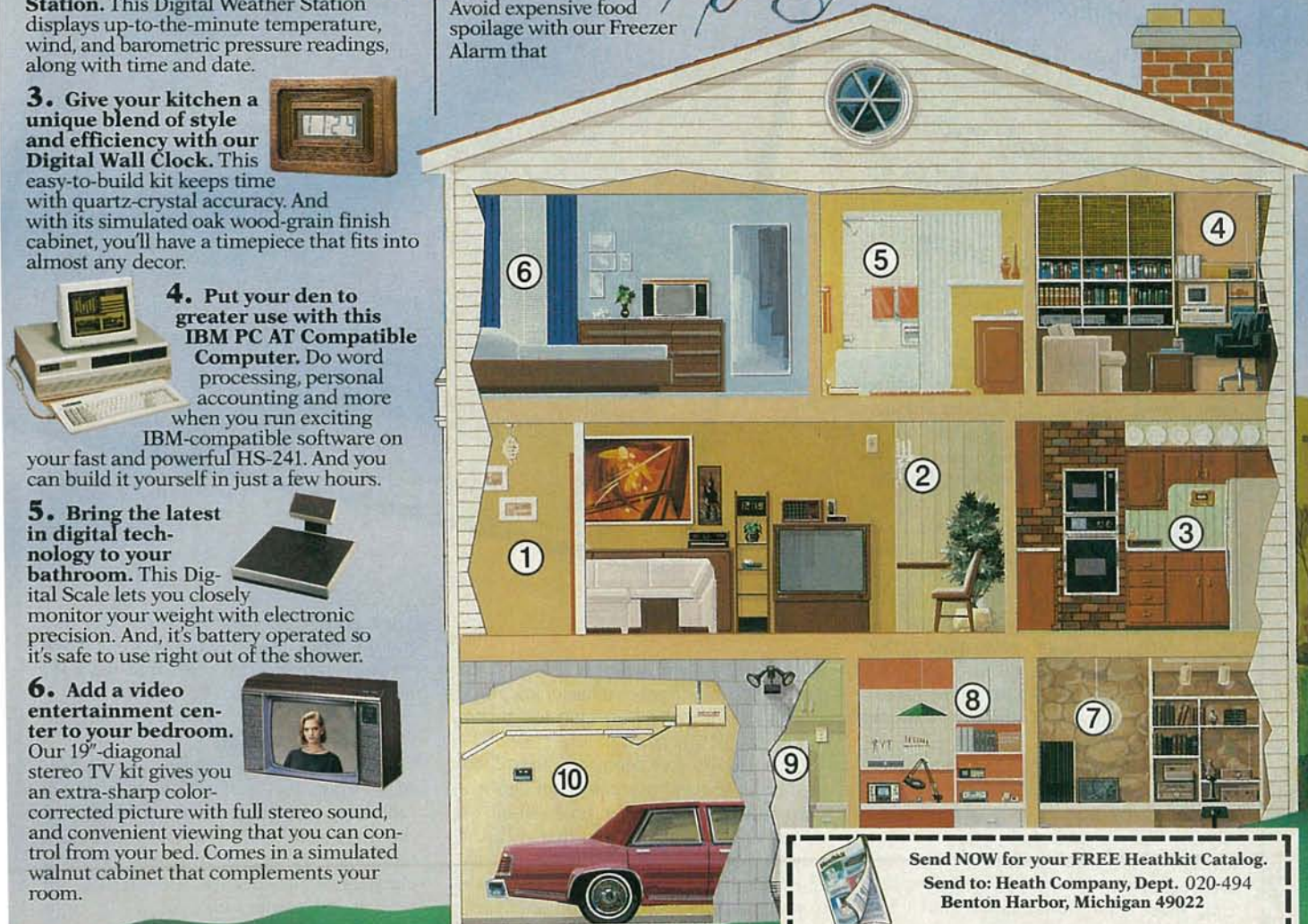

Heathkit[®]
Heath
Company

CIRCLE 86 ON FREE INFORMATION CARD

Send NOW for your FREE Heathkit Catalog.
Send to: Heath Company, Dept. 020-494
Benton Harbor, Michigan 49022

Name _____
Address _____
City _____ State _____ Zip _____
A subsidiary of Zenith Electronics Corporation CL-789A

Apply for a Patent

Applying for a patent is not as difficult or as costly as it might seem. In this article we show you how to obtain a patent and give your inventions the full protection of the law.

DAVE SWEENEY

IN TINKERING AROUND IN OUR WORKSHOPS, many of us have come up with a circuit or design that we think is unique. But how do you go about finding out if your idea really is unique, and if it is worth the time and money required to obtain a patent?

Actually, though the process may sound intimidating, applying for a patent is a relatively simple task. True, the cost of hiring a good patent attorney is high; but if you are willing to do some of the work yourself, you can save quite a few dollars. In this article, we are going to dispel a few superstitions about the patent process and show you the best ways to protect your ideas.

There is a down side to the patent procedure. Patenting demands time for writing, requires attention to detail, and appears to the uninitiated as the complex domain of the legal profession. As a result, technically oriented people often shy away from patent applications and what seems like an overwhelming amount of paperwork. But thanks to some recent legislation, the situation for inventors has improved. Since the Patent and Copyright Act of 1982 was enacted, examiners in the Patent and Trademarks Office (PTO) have

been helping those who need it with the paperwork. That makes it easier and more affordable for garage or table-top inventors to protect their ideas.

One way to save money in the patent process is to compose your own application. You should hire a professional to examine the document, but that will cost considerably less than paying for the time and effort to draft the original. That's not to say that patent attorneys are not necessary. Far from it. If your application encounters "interference" (that's when another applicant claims that he had the same idea) you will want a professional to ensure that your rights are adequately protected. Many patent attorneys have spent a

great portion of their lives studying the patent laws and practices that have evolved over the 180 years that the PTO has been in existence.

Protecting creativity

A patent for an invention is a government grant to "...the right to exclude others from making, using, or selling..." the invention. The patent may be maintained for 17 years. A patent is not a copyright or trademark. Copyrights and trademarks confer other rights to creations, or "ideas." Since copyrights and trademarks protect creative works they appear similar to patents, but each is completely different and serves a different purpose. A copyright protects the writings of an author against copying, and in some

As a below named inventor, I hereby declare that:

My residence, post office and citizenship are as stated below next to my name.

I believe I am the original, first and sole inventor (if only one name is listed below) or an original, first and joint inventor (if plural names are listed below) of the subject matter which is claimed and for which a patent is sought on the invention entitled Circuit for a Battery-Powered Wetness Alarm, the specification of which

(check one) is attached hereto as application # _____
 was filed on _____ and was amended on _____ (if applicable)

I hereby state that I have reviewed and understand the contents of the above-identified specification, including the claims, as amended by any amendment referred to above. I acknowledge the duty to disclose information which is material to the examination of this application in accordance with Title 37, Code of Federal Regulations, paragraph 1.65(a).

I hereby claim foreign priority benefits under Title 35, United States Code, paragraph 119 of any foreign application(s) for patent or inventor's certificate listed below and have also identified below any foreign application for patent or inventor's certificate having a filing date before that of the application on which priority is claimed.

(number)	(country)	(Day/Month/Year filed)	Priority Claimed	
			Yes	No
			<input type="checkbox"/>	<input type="checkbox"/>

I hereby claim the benefit under Title 35, United States Code, paragraph 120 of any United States application(s) listed below and, insofar as the subject matter of each of the claims of this application is not disclosed in the prior United States application in the manner provided by the first paragraph of Title 35, United States Code, paragraph 112, I acknowledge the duty to disclose material information as defined in Title 37, Code of Federal Regulations, paragraph 1.56(a) which occurred between the filing date of the prior application and the national or PCT international filing date of this application.

(application serial no.)	(filing date)	(Status) (patented, pending, abandoned)

I hereby declare that all statements made herein of my own knowledge are true and that all statements made on information and belief are believed to be true; and further that these statements were made with the knowledge that willful false statements and the like so made are punishable by fine or imprisonment or both, under Section 1001 of Title 18 of the United States Code and that such willful false statements may jeopardize the validity of the application or any patent thereon.

Full Name: _____ Address: _____
 Inventor's Signature: _____ Citizenship: _____
 Date: _____

**TABLE 1—
LIST OF DEPOSITORY LIBRARIES**

Location	Library
Albany, NY	New York State Library
Atlanta, GA	Georgia Tech Library
Baton Rouge, LA	Troy H. Middleton Library
Birmingham, AL	Public Library
Boston, MA	Public Library
Buffalo, NY	Buffalo and Erie County Public Library
Charleston, SC	Medical University of South Carolina
Chicago, IL	Public Library
Cincinnati, OH	Public Library
Cleveland, OH	Public Library
Columbus, OH	Ohio State University Library
Dallas, TX	Public Library
Denver, CO	Public Library
Detroit, MI	Public Library
Durham, NH	University of New Hampshire
Houston, TX	Fondren Library
Kansas City, MO	Linda Hall Library
Lincoln, NB	University of Nebraska-Lincoln
Los Angeles, CA	Public Library
Madison, WI	Kurt F. Wendt Engineering Library
Memphis, TN	Memphis & Shelby County Public Library
Milwaukee, WI	Public Library
Minneapolis, MN	Minneapolis Public Library
Newark, DE	University of Delaware
Newark, NJ	Public Library
New York, NY	Public Library
Philadelphia, PA	Franklin Institute
Pittsburgh, PA	Carnegie Library
Providence, RI	Public Library
Raleigh, NC	D.H. Hill Library
Sacramento, CA	California State Library
Seattle, WA	University of Washington Engineering Lib.
St. Louis, MO	Public Library
Stillwater, OK	Oklahoma State University Library
Sunnyvale, CA	Patent Information Clearinghouse
Tempe, AZ	Science Library, Arizona State Library
Toledo, OH	Public Library
Univ. Park, PA	Pattee Library, Penn State University

photocopies of it is against the law. Copyrights are registered in the Copyright Office in the Library of Congress. (For more information, write to Register of Copyrights, Library of Congress, Washington, D.C. 20540.)

Trademarks relate to any word, name, symbol, or device that is used in trade to indicate the origin of goods, and to distinguish them from the goods of others. Information on registering trademarks can be found in a pamphlet, "General Information Concerning Trademarks," which may be obtained from the Patent

and Trademark Office.

The PTO is located at Crystal Plaza, 2021 Jefferson Davis Highway, Arlington, VA 22202. It maintains the only complete collection of U.S. patent literature filed according to subject matter. The examiners use one set of search files while the public has access to another collection in the Public Search Room. Arranged by subject according to a classification system, the patent search files contain more than 300 classes, and more than 90,000 subclasses. Catalogs and a computer system cross-reference the 4 million US pat-

TABLE 2—COVER LETTER

Date

Commissioner of Patents and Trademarks
Washington, District of Columbia 20231

Request for Participation in
Disclosure Document Program:
Disclosure of (Your Name)
Entitled: (Name of Your Invention)

Sir:

Attached is a disclosure of my above-entitled invention consisting of one (1) sheet of written description and one (1) separate drawing, a \$6 check, a stamped addressed return envelope, and a duplicate copy of this letter.

It is respectfully requested that this disclosure be accepted and retained for two years (or longer, if I later refer to it in a paper filed in a patent application) under the Disclosure Document Program.

Very Respectfully,

(Inventor's Name)

cases includes performing and recording rights. This magazine, for example, is copyrighted, and selling unauthorized

TABLE 3—THE DECLARATION

As a below named inventor, I hereby declare that:

My residence, post office and citizenship are as stated below next to my name.

I believe I am the original, first and sole inventor (if only one name is listed below) or an original, first and joint inventor (if plural names are listed below) of the subject matter which is claimed and for which a patent is sought on the invention entitled Circuit for a Battery-Powered Wetness Alarm, the specification of which

(check one) is attached hereto
 was filed on _____ as application # _____
 and was amended on _____
 (if applicable)

I hereby state that I have reviewed and understand the contents of the above-identified specification, including the claims, as amended by any amendment referred to above. I acknowledge the duty to disclose information which is material to the examination of this application in accordance with Title 37, Code of Federal Regulations, paragraph 1.65(a).

I hereby claim foreign priority benefits under Title 35, United States Code, paragraph 119 of any foreign application(s) for patent or inventor's certificate listed below and have also identified below any foreign application for patent or inventor's certificate having a filing date before that of the application on which priority is claimed.

Prior Foreign Application(s)			Priority Claimed	
(number)	(country)	(Day/Month/Year filed)	<input type="checkbox"/> Yes	<input type="checkbox"/> No

I hereby claim the benefit under Title 35, United States Code, paragraph 120 of any United States application(s) listed below and, insofar as the subject matter of each of the claims of this application is not disclosed in the prior United States application in the manner provided by the first paragraph of Title 35, United States Code, paragraph 112, I acknowledge the duty to disclose material information as defined in Title 37, Code of Federal Regulations, paragraph 1.56(a) which occurred between the filing date of the prior application and the national or PCT international filing date of this application.

(application serial no.)	(filing date)	(Status) (patented, pending, abandoned)
--------------------------	---------------	--

I hereby declare that all statements made herein of my own knowledge are true and that all statements made on information and belief are believed to be true; and further that these statements were made with the knowledge that willful false statements and the like so made are punishable by fine or imprisonment or both, under Section 1001 of Title 18 of the United States Code and that such willful false statements may jeopardize the validity of the application or any patent thereon.

Full Name: _____ Address: _____
 Inventor's Signature: _____
 Date: _____ Citizenship: _____

mixture and use of materials.

Plant patents cover organic matter such as flowers and vegetables. Lately, those patents have been used to protect biochemical developments such as gene splicing.

A *structure patent* describes an object, such as a spoon, and explains how the object works.

Finally, *regular utility patents* are used to protect processes or systems and to describe the way a group of components or materials operate together. That type of patent usually includes schematic diagrams, flow charts, mechanical drawings, or combinations of those, together with descriptions of how the invention works. That type of patent is the one most likely to be obtained for an electronics-oriented invention.

The first steps

Before writing patent applications or raising the fees for lawyers, you must establish the date when you first conceived the invention. A *disclosure document* and your laboratory notebook together will satisfy that need to certify the idea's conception, as well as the building, testing, and development of the hardware.

A tale that occasionally surfaces suggests that you mail yourself a registered letter containing a description of the invention, and never open the letter until the patent court asks for it. That way, you would have a dated reference for your invention. While sending yourself the registered letter probably won't hurt, the correct method for establishing the date of your invention is to take advantage of the invention-disclosure process of the PTO. That process allows you to submit a short description of the invention and receive a time-stamped receipt of its entry into the PTO archives. The PTO assigns a reference number to the disclosure and mails the number to you for inclusion in your patent application, should you submit one. The PTO will maintain the document for two years after you submit the disclosure. That description of the invention need not contain the same level of detail as that in the patent application, but the information must describe the idea sufficiently to be judged the same idea.

That disclosure document contains specific sections that fully communicate the essence of your idea. To introduce your disclosure, a standard letter accompanies the document. A sample of the letter is shown in Table 2. As shown, the letter lists the contents of the submission, and states that you desire participation in the program. Note that you must include a check or money order for \$6, and a stamped, self-addressed envelope for the PTO to return your registration card.

The rest of the disclosure is up to you, but should contain the following sections: Title (the name of the invention); inventor

ents into related subclasses. More than 10 million foreign patents and about 1 million copies of articles from professional journals are also filed according to the classification system. The weekly "Official Gazette" outlines the 1200 or so patents granted for that week.

Depository libraries, located throughout the U.S. (see Table 1), contain copies of some or all of the U.S. patents, but arranged in numerical order. If you want a copy of a patent and you know its number, you can locate a copy at one of those libraries, or you can order photocopies of the patent from the PTO for 50 cents each.

Types of patents

Let's briefly mention the types of patents that the government grants, then concentrate on the type that usually applies to electronics circuits and equipment.

First, a *design patent* protects the general appearance and visual arrangement of an invention. You may have created a control panel with an LED and knob arrangement that you think is special. The design patent consists of a professional drawing of your design, along with the proper identifying paperwork called the *declaration*.

Materials patents, usually used to protect chemical formulations, describe the

(your name and address); function (a statement about what the invention does); use (a description of the invention's use); description (the physical/electrical description of the invention, with references to any accompanying drawings) and differences from existing devices (a statement of how your invention improves upon or differs from other devices). As indicated in the preceding, you should include a drawing or drawings of your invention. For that document, the drawings need not be complete (you may be still developing the invention), but it should embody the creative part of the idea.

Your notebook can become critical in establishing your rights. Experienced patent applicants use a standard log-book technique, the same as is used in scientific laboratories. Date everything, show diagrams, objects, tests, and results, and annotate every page with the following words: "I have read and understood." Have someone (but not a relative) who is knowledgeable enough to understand what they have read, sign each page. The notebook should be a sewn-together type, like a school copy book. Write everything in ink. Number the pages. To correct errors, cross out entries and initial them rather than erasing. Use the page numbers and dates for reference within the notebook. Keep in mind that the primary use of the book is to tell the complete and detailed story of how and when you came to produce the invention.

With your notebook up to date and your disclosure receipt on its way back from the PTO, you are ready to begin a search for other patents that relate to yours (prior art) and to prepare your application. If you would rather hire a professional for the search without incurring the full expense of a patent attorney, you may want to talk to a patent agent.

You can find a qualified patent agent listed in the Register of Patent Attorneys and Agents, which can be ordered from the Superintendent of Documents, U.S. Government Printing Office, Washington, DC 20402. The price is \$12. To be listed, patent agents must comply with regulations that require good moral character and good reputation, and must have the legal, scientific, and technical qualifications necessary to render a valuable service to applicants.

Patent agents maintain access to the PTO library, prepare patent applications, and deal with the examiners. While they are barred from practicing law and can not conduct patent litigation, they are usually as qualified as patent attorneys to perform patent searches and prepare patent applications. But for an interesting experience, and to acquire the knowledge necessary to file future patent applications, you can prepare the paperwork yourself.

TABLE 4—THE SPECIFICATION

TITLE: CIRCUIT FOR A BATTERY-POWERED WETNESS ALARM

CROSS REFERENCE TO RELATED APPLICATIONS:

Patent Disclosure (#), '(title)' submitted to the
Commissioner of Patents and Trademarks on (date)

RIGHTS TO INVENTIONS MADE UNDER FEDERALLY-SPONSORED RESEARCH AND DEVELOPMENT: None.

BACKGROUND OF THE INVENTION:

A quantity of electrical and mechanical water detection and water alarm mechanisms exists which sense the presence of water and cause either local or remotely located alarms to sound. Until semiconductor electronics were developed, an alarm capable of sensitivity to wetness has been costly to build because amplification is necessary and vacuum tubes require hazardous operating voltages. Semiconductor electronics devices have been used to provide the sensitivity to wetness by amplifying small changes resulting from electrical conduction on a wet floor. The power to operate these semiconductor electronics devices used in wetness alarms can be supplied from batteries.

Because batteries wear out, the monitor function provided by the alarm may cease without external indication provided by extra circuitry.

Summary:

This invention increases the battery life in a battery-powered alarm which monitors a surface for wetness. When water wets a surface which is touched by two electrodes, the wet surface becomes a high resistance circuit connecting a battery to a Silicon Controlled Rectifier (herein called an SCR). Battery voltage thus connected causes the SCR to conduct. Because the SCR is in series with a crystal noise generator, the battery power activates the noise generator thus sounding an alarm to wetness on the surface touched by the electrodes. In its monitor state, with no water on the surface, the SCR operates as a reverse-biased diode. In this state, no electric current is required to flow from the battery to the circuit to maintain the monitor function.

Brief Description of the Drawing:

Figure 1 is an electrical schematic diagram of the invention. The electrodes are any metal that conducts electricity. SCR1 is an SCR. BZ1 is a noise generator. B1 is a battery. R1 is a resistor.

Best Mode for Carrying Out the Invention:

The invention should be housed in a container having a water tight seal, and having the electrodes mounted externally to touch the monitored surface. The battery capacity should equal that necessary to operate the noise generator plus that necessary to overcome SCR resistance when the noise generator is turned on.

The patent application

To illustrate one possibility for a patent application, let's look at the circuit in Fig. 1. The circuit is designed to warn of water or moisture on a surface, such as a floor. Only slight dampness is required to set off the alarm, as any dampness will reduce

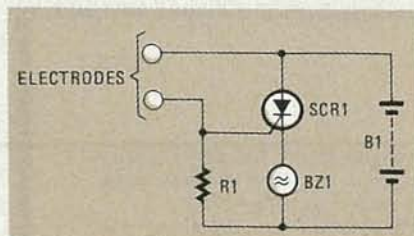

FIG. 1—A BATTERY-POWERED MOISTURE alarm. The circuit might be patentable based on the fact that, in the absence of water, the SCR remains off and negligible current flows, thereby conserving battery life.

the resistance between the electrodes and trigger SCR1. That in turn causes a piezoelectric sounder to issue an audible alarm. Once SCR1 is triggered it stays on even if the water evaporates.

What makes the circuit different, and hence patentable, is the fact that when no water is present, SCR1 remains off and no current flows through the circuit, except, of course, for leakage. That means that the battery could last for almost its entire shelf life. Now that we have a subject for a patent, let's see how a patent application would be prepared.

The first part of the application is called a *declaration*. A sample declaration is shown in Table 3. It contains a standard oath and statement of your intent to file for patent protection. If you expect to submit future patent applications, then make a few photocopies with blanks as shown. In

our sample, the first of those blanks, the title of the invention, has been filled in with the name of the circuit.

The rest of the document consists of the *Specification*, shown in Table 4, the *Claims* shown in Table 5, and the *Abstract*, shown in Table 6. Let's look at those in more detail.

As you become familiar with the specification, you will realize that it begins with general information and becomes more detailed as it proceeds. Remember that the specification must describe the invention sufficiently to be understood by someone "skilled in the art." You need not explain the physics of electricity or electronics theory.

Let's consider the *title*. Placed at the top of the page, the title should contain two to seven words, convey the essence of the idea, and be limited to the matter discussed in the document. For our example

water alarm, the title "Electric Water Alarm" would not be the best choice because the essence of the idea is not merely to sound an alarm to the presence of water. The alarm might merit a patent because the invention's battery will last a long time and thus allow the alarm to be self-contained and portable. A better title might be "Portable Battery-Powered Water-Alarm Circuit," or, better yet, "Circuit for a Portable, Battery-Powered Water Alarm."

In the paragraph *Cross References to Related Applications*, we mention the disclosure that was filed previously and include its title and the registration number supplied by the PTO.

Rights to Inventions made under Federally-sponsored Research and Development means what it says. For many applications, the rights must be shared by a laboratory or institution funding the de-

A SHORT HISTORY OF THE PTO

While the first recorded patent grant occurred in the Republic of Venice in 1474 AD, our U.S. patent system evolved from the 17th century English system, when patents for inventions were granted during the reign of Queen Elizabeth. Across the Atlantic, the Americans disliked monopolies, but continued the patent process because they recognized the benefits to society and the just nature of rewarding innovation.

The earliest American patent was granted by the Massachusetts Bay colony, in 1641, to Samuel Winslow for a salt-manufacturing process. As the colonies prospered, the individual states granted patents, but the localized process became recognized as inconvenient and expensive. Proposals that the Federal government grant patents and secure copyrights were written into the Constitution. Article 1, Section 8 states: Congress shall have the power "to promote the progress of science and useful arts, by securing for limited times to authors and inventors the exclusive right to their respective writings and discoveries."

The patent office became a distinct bureau in 1802 when a separate official in the State Department was installed as the Superintendent of Patents. Patent-law revisions enacted in 1836 reorganized the office and designated the official in charge as the Commissioner of Patents. The Patent Office remained in the State Department until 1849, when it was transferred to the Department of the Interior. In 1925 control of the Patent Office was transferred to the Department of Commerce, where it is today. **R-E**

TABLE 5—THE CLAIMS

page 2

CLAIM:

What's claimed is:

1. An electric circuit for use in a wetness alarm, said circuit comprising:
 - a Silicon Controlled Rectifier, an electric noise generator; two electrodes; a resistor; and a battery.
2. A circuit as defined in Claim 1 connected such that electric current is connected from said battery to said noise generator through said Silicon Controlled Rectifier.
3. A circuit as defined in Claim 1 connected such that said electric noise generator operates only when the electrical resistance between said electrodes decreases.

TABLE 6—THE ABSTRACT

page 3

ABSTRACT:

An electric circuit for use in a portable wetness alarm. The circuit senses the presence of water on a surface and sounds an alarm. When no water exists, the circuit requires no power from its source because the semiconductor switch, a Silicon Controlled Rectifier, remains off and offers a very high impedance to the power source. As a result, the circuit performs its monitor function for the battery shelf life without replacement.

velopment. For our illustration there is no sponsorship.

In *Background of the Invention* (which also could be called *Technical Field*), we begin to tell the examiner about the invention. The background should describe the general nature of the invention and may include a paraphrasing of the applicable U.S. patent classification. Following the general statement, a description of the prior art should be included. In addition, problems that the invention solves when compared with other inventions should be discussed.

The *Summary* contains a general statement of the invention. In the summary, we try to point out the advantages of the invention or describe how it solves the problems that exist in the prior art. If possible, the concept that makes the invention special should be discussed. Parts necessary to build the invention (for example, SCR's, resistors, etc.) should be mentioned only to the extent that they contribute to an understanding of the invention.

In the next section, *Brief Description of Drawing(s)*, we refer to the drawing and describe the function of the elements. All

continued on page 69

TV SIGNAL DESCRAMBLING

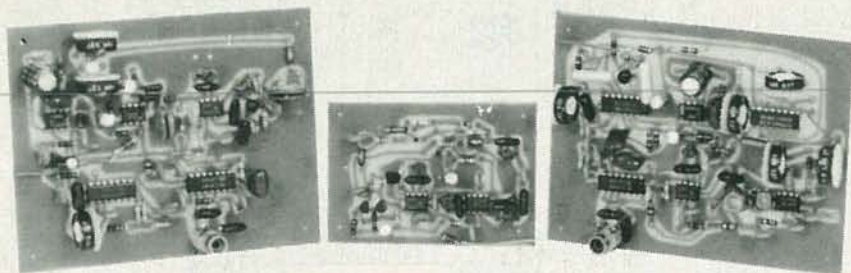

This month we show you how to build and align a gated-pulse decoder.

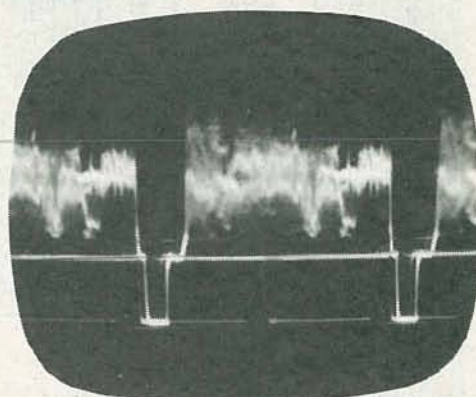

WILLIAM SHEETS and RUDOLF F. GRAF

Part 7 LAST TIME WE LOOKED at a practical decoder for the sinewave scrambling system. This month we'll look at another practical descrambler. It will decode the gated-pulse system.

Gated-pulse descrambler

The popular gated-pulse system operates by suppressing the sync-pulse level so that the amplitude of the video signal is higher than that of the sync tips. That throws off the TV's sync circuit, which is designed to assume that the highest amplitude signal is the sync. The result is a picture that rolls, tears, and is generally unwatchable.

A 15.734-kHz reference signal is used in restoring the sync. That signal is modulated onto the channel's audio carrier, which is located 4.5 MHz above the video center frequency. The audio signal may be scrambled or unscrambled. If scrambling is used, it is done by stripping the audio away from the main audio channel and locating it on a 31.5-kHz subcarrier.

In order to decode a gated-pulse signal, we have to restore the correct sync-to-video-amplitude relationship. The circuit shown in Fig. 1 does just that. Let's see how it works.

The scrambled signal is fed to jack J1 and coupled to IC1, an MC1350 variable-gain IF amplifier. The gain of that stage is

determined by the instantaneous voltage at pin 5. Maximum gain, about 20 dB, is achieved when that voltage is +5. Raising the voltage at pin 5 causes the gain to drop. For instance, at +6 volts, gain drops to about 12–14 dB. That feature of IC1 gives us a way to restore the proper relationship between the sync and the video. That is, raising the gain of that stage during the sync pulses will cause the peak sync tip to once again have a higher amplitude than the peak video. Gain is raised by applying a negative-going pulse to pin 5.

The majority of the decoder's circuitry is used to generate the required pulses. A portion of the amplified RF-input signal, taken from the output of IC1, is coupled to IC2, an MC1330 video detector/amplifier. That IC has a gain of about 30 dB. The output, at pin 4, is a scrambled video signal. That signal is fed to IC4, an MC1358 TV-sound IF amplifier. Among other things, that IC functions as a quadrature FM detector and a limiter. The L2-C15 network is used to tune the detector to 4.5 MHz.

Remember that the decoding reference signal is modulated onto the 4.5-MHz sound carrier. It is extracted from the carrier using an MC1310 FM-stereo PLL demodulator, IC5. That IC contains a PLL, audio demodulators, a pilot-carrier output, and a stereo-lamp output, which is used as a pilot-carrier detector here.

The audio signal appears at pin 12 of IC4 and is coupled to IC5 via a highpass filter (C27, C28, R18, and R19). Resistors R20 and R21 are used to determine the frequency of IC5's internal VCO. By varying the setting of R21, the VCO should be made to run at 4 times the horizontal frequency, or at approximately 63 kHz. When that is done, a 15.734-kHz signal appears at pin 10. That signal is amplified by Q1 and passed to IC6, a CD4528 dual monostable multivibrator.

The dual monostable handles the task of generating the missing sync pulses. The signal at the collector of Q1 is fed to one monostable at pin 4. That monostable generates wide (30 to 60 μ s) pulses, with a repetition rate of 1/15.734 kHz, at pin 13. That pulse train is used to trigger a second monostable multivibrator (pin 12) which generates a nominal 11- μ s pulse every 63 μ s. The network consisting of R28, R31, and C34 sets the pulse width of the first monostable; the network consisting of R32, R31, and C35 sets the pulse width of the second monostable. Since the second monostable is triggered by the falling edge of the pulse from the first monostable, we can control the position of the 11- μ s pulse generated by the second monostable by varying the length of the pulse generated by the first monostable. Therefore, we can place the 11- μ s pulse anywhere we want during the video-line

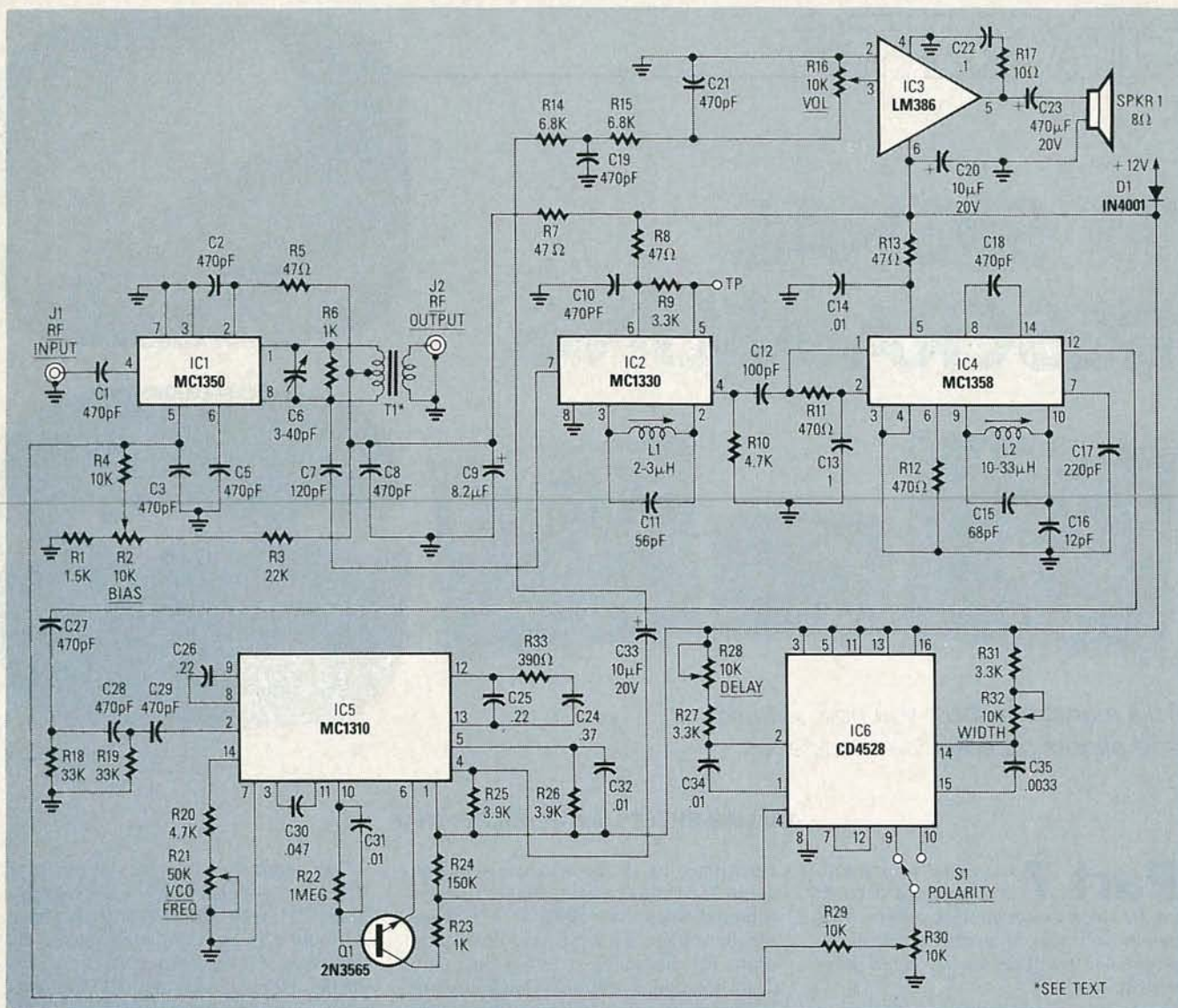

FIG. 1—DESCRAMBLE GATED-PULSE SIGNALS using this easy-to-build circuit. Information for winding transformer T1 and coil L1 can be found in the text.

interval. Of course, we want to time it so that pulse coincides with the sync-pulse intervals. Potentiometer R28 sets that timing, and potentiometer R32 is used to tailor the pulse-width output to 11 μ s.

The CD4528 outputs both a positive- (pin 10) and negative- (pin 9) going pulse train. As previously mentioned, for descrambling we need a negative-going pulse. That circuit could also be used to scramble a signal. That is done by selecting the positive-going pulse. Switch S1 is used to select the appropriate polarity. If you are always going to use the circuit for the same application, the switch could be replaced by a jumper. Resistors R29 and R30 form a voltage divider that drops the amplitude of the pulse train to the appropriate level for the AGC circuit of IC1.

The RF output of the circuit is taken from pins 1 and 8 of IC1. A tuned circuit consisting of C6, R6, and T1 provides a way of coupling the output of the IC to a typical 75-ohm load connected to J2.

Note that in the gated-pulse system, the

pulses within the vertical-blanking interval are not altered. That's because some more complex variations of the gated-pulse scrambling technique hide their descrambling information within that interval; this circuit *will not* decode signals whose descrambling information is hidden in that way. Therefore, the scrambling signal is suppressed during the vertical-blanking interval. When the scrambling signal is suppressed, there is no input to pin 2 of IC5, causing pin 6 of that IC to go high. The result is that transistor Q1 is cut off during the vertical blanking interval, and the monostable is not triggered.

In some systems audio is "scrambled" by stripping it away and hiding it on a 31.5-kHz subcarrier. The audio is recovered by IC5, with right-channel and left-channel information appearing at pins 4 and 5. Since conventional television sound is monophonic, we only need the audio at one of the pins. Therefore, the left channel audio at pin 4 is coupled to IC3, an LM386 audio amplifier via C33, and a

de-emphasis network that consists of R14, C19, R15, and C21. The output of IC3 is sufficient to drive a standard 8-ohm speaker. Volume can be adjusted using R16. If the audio is not "scrambled", the audio circuit just described is not needed and therefore can be eliminated.

Building the circuit

With the possible exception of the coils and the transformer, all components should be easy to locate. In addition, a complete kit of parts, including coils, PC board, etc., is available from the supplier mentioned in the Ordering Information. If you'd like to etch your own board, use the pattern that is provided in PC Service. The parts-placement diagram is shown in Fig. 2. A photograph of the completed board is shown in Fig. 3.

Note that coil L2 is a custom component and is available only from the supplier mentioned; its cost is nominal. Transformer T1 consists of two windings on the same 1/4-inch form. The primary is

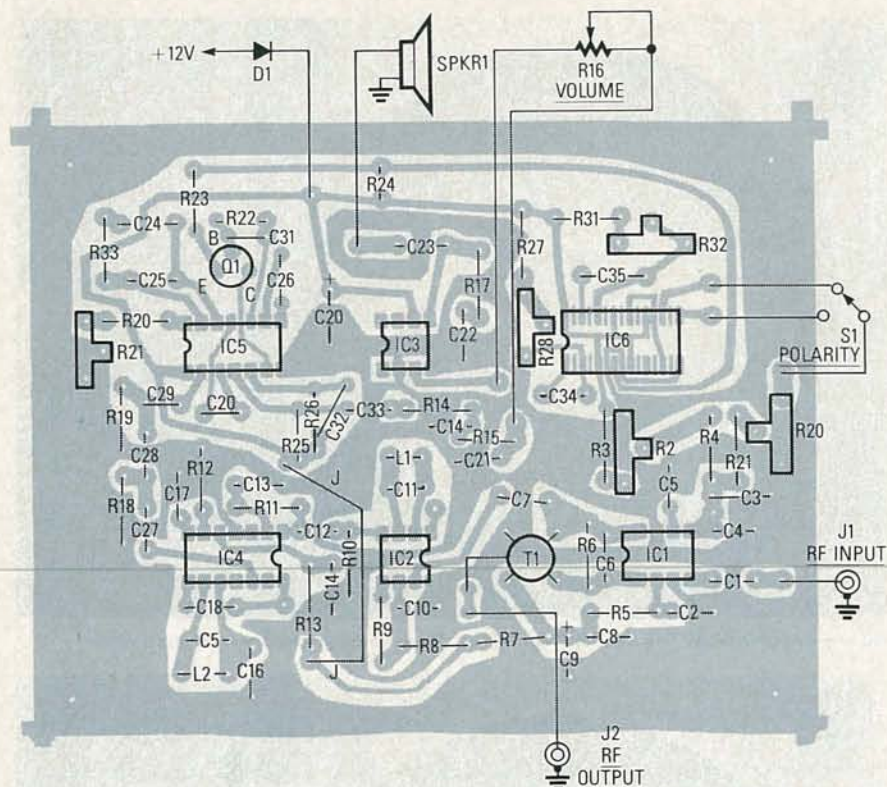

FIG. 2—PARTS-PLACEMENT DIAGRAM for the gated-pulse decoder. Most of the circuit's components mount on the PC board.

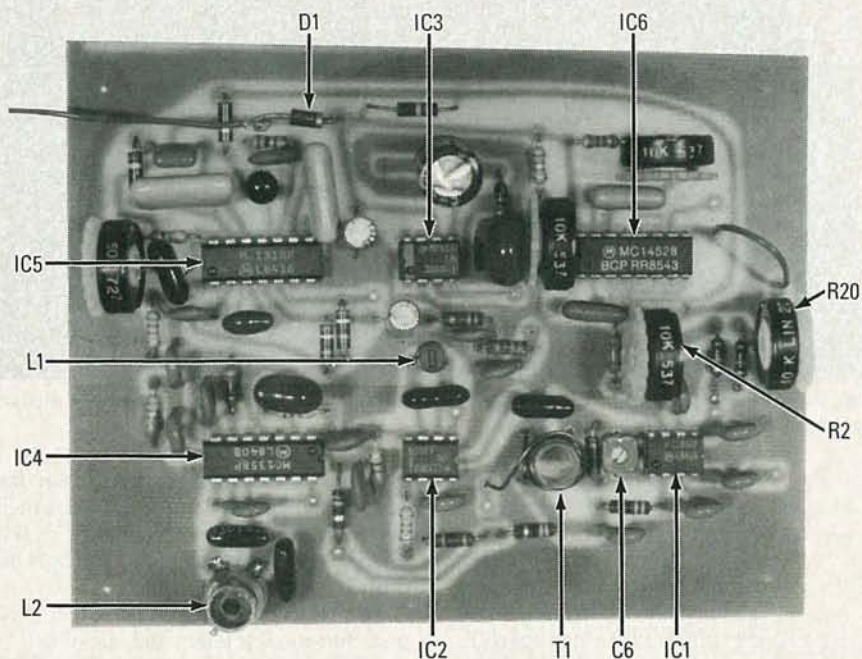

FIG. 3—THE COMPLETED BOARD should resemble the one shown here. The locations of several key components have been noted.

6 turns of No. 22 enameled wire, center-tapped; the secondary is one turn of No. 22 enameled wire. Coil L1 consists of 8½ turns of No. 22 enameled wire on an 8-32 screw. After winding the coil, remove the screw and replace it with an appropriate tuning core. As discussed last time, that core can be removed from a coil scavenged from an old radio or TV set. An

appropriate core is also manufactured by Midland Ross, Cambion Division (One Alewife Pl., Cambridge MA 02140); it is part number 515-3225-03-21-00.

Checkout

Once all components are mounted on the PC board, check the board for solder bridges, poor connections, improperly

Ordering Information

The following are available from North Country Radio, P.O. Box 53, Wykagyl Station, New Rochelle, NY 10804: Complete sinewave decoder kit, including PC board (metal box for interface circuit not included), item SW-1, \$52.95 plus \$2.50 postage and handling; Pulse decoder kit, including PC board, item PD-1, \$54.95, plus \$2.50 postage and handling; Outband decoder kit, including PC board, item OB-1, \$34.95 plus \$2.50 postage and handling. All three kits can be purchased together for \$129.95 plus \$3.50 postage and handling. The LX10-33 coil is available separately for \$4.00, plus \$1.75 for postage and handling. NY residents please add appropriate sales tax.

The authors of this series on television scrambling and descrambling have written a comprehensive book on the topic. Entitled *Video Scrambler and Descrambler for Satellite and Cable TV*, it is available as book no. 22499 from Howard W. Sams & Co., Indianapolis, IN 46268.

oriented components, and any other errors. Measure the resistance between the supply and ground rails with an ohmmeter. It should be several hundred ohms. If the resistance is less than about 100 ohms, something is wrong.

If all is OK, connect a signal generator set at 61.25 MHz or 67.25 MHz (Channel 3 or 4) between the input and ground. Set R22 so that +5 volts appears at pin 5 of IC1. Set R21, R28, R30, and R32 to their center positions. Connect an oscilloscope via an RF detector probe to the secondary of T1.

Amplitude-modulate the output of the signal generator 80% with an external 1-kHz, 1-millivolt signal (one technique for doing that was discussed in the last installment of this series). Adjust C6 for maximum output. If all is as it should be, you should get a total gain of 15 to 20 dB from IC1. With a 1-millivolt input, the output will be between 5 and 10 millivolts.

Next, connect the oscilloscope to pin 4 of IC2. You should see some trace of 1-kHz modulation. Adjust L1 for maximum modulation on the oscilloscope. Although the level is not critical, if everything is OK, the signal should peak at about 200 mV.

Next, connect a Channel-3 or Channel-4 RF signal source to the circuit's input. One good source for such a signal is a VCR. Connect the scope to pin 12 of IC4 and adjust L2 for maximum signal (maximum recovered TV audio). You should get 100 millivolts peak-to-peak, or more. If IC3 is used, connect a speaker to its output (pin 5). Temporarily, jumper C21

PARTS LIST

—GATED PULSE DECODER

All resistors 1/4 watt, 10%, unless noted

R1—1500 ohms
 R2, R28, R30, R32—10,000 ohms, trimmer potentiometer
 R3—22,000 ohms
 R4, R29—10,000 ohms
 R5, R7, R8, R13—47 ohms
 R6, R23—1000 ohms
 R9, R27, R31—3300 ohms
 R10, R20—4700 ohms
 R11, R12—470 ohms
 R14, R15—6800 ohms
 R16—10,000 ohms, potentiometer, log taper
 R17—10 ohms
 R18, R19—33,000 ohms
 R21—50,000 ohms, trimmer potentiometer
 R22—1 megohm
 R24—150,000 ohms
 R25, R26—3900 ohms
 R33—390 ohms

Capacitors

C1—C3, C5, C8, C10, C18, C19, C21, C27—C29—470 pF, ceramic disc
 C4—not used
 C6—3—40 pF, trimmer
 C7, C16—12 pF, NPO
 C9, C20, C33—10 μ F, 16 volts, electrolytic
 C11—56 pF, NPO
 C12—100 pF, NPO
 C13, C22—0.01 μ F, Mylar
 C14, C31, C32, C34—0.01 μ F, ceramic disc
 C15—68 pF, NPO
 C17—220 pF, NPO
 C23—470 μ F, 16 volts, electrolytic
 C24—0.39 μ F, Mylar
 C25, C26—0.22 μ F, Mylar
 C30—0.047 μ F, Mylar
 C35—0.0033 μ F, Mylar

Semiconductors

IC1—MC1350 IF amplifier (Motorola)
 IC2—MC1330 video detector (Motorola)
 IC3—LM386 audio amplifier (National)
 IC4—MC1358 audio IF amplifier and detector (Motorola)
 IC5—MC1310 FM stereo demodulator (Motorola)
 IC6—CD4528 dual monostable multivibrator (RCA)
 Q1—2N3565 NPN transistor
 D1—1N4001 diode

Other components

L1—see text
 L2—18 μ H, LX10-33, see text
 T1—see text
 S1—SPST, toggle or slide, optional
 J1, J2—phono jacks

Miscellaneous: PC board, speaker (8 ohms), wire, solder, etc.

to pin 12 of IC4 using a 0.1- μ F capacitor. Adjust L2 for maximum audio. Note that the audio may sound "tinny" but that is because the de-emphasis circuits are bypassed for this test.

Next, apply a 50-millivolt, 15.7-kHz sine wave from a signal generator to the junction of C28, C29, and R19. Connect the oscilloscope to the collector of Q1.

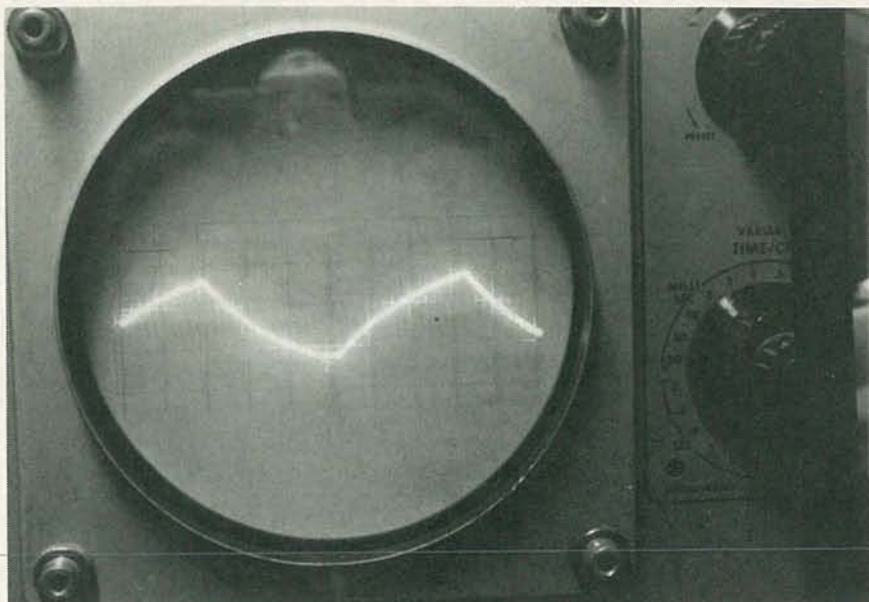

FIG. 4—WAVEFORM AT THE COLLECTOR OF Q3. Scope settings are 10 ms/div and 5 volts.

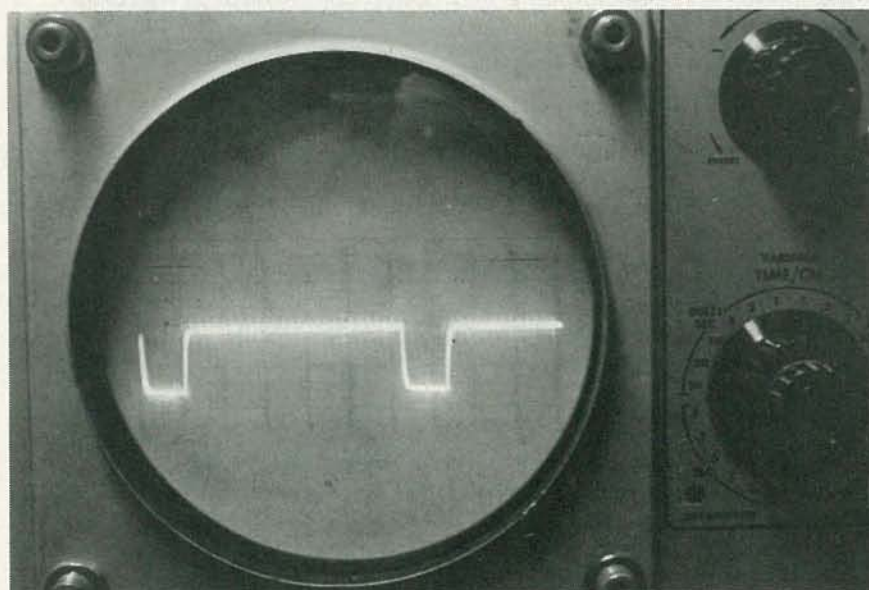

FIG. 5—WITH THE OSCILLOSCOPE CONNECTED across R30, adjust R32 until this waveform appears. Oscilloscope settings are the same as in Fig. 4.

Slowly adjust R21 until the waveform shown in Fig. 4 "pops in." That indicates phase lock.

Next, connect the oscilloscope across R30. Adjust R32 until the waveform shown in Fig. 5 appears. Then connect the oscilloscope to pin 7 of IC6 and vary R28. You should see a pulse whose width varies with the setting of R28. That checks out IC6 and its associated circuitry. Finally, connect the scope to pin 5 of IC1. Adjust R30 to obtain a 1-volt negative-going pulse, riding on a +6-volt DC level.

Before trying the circuit out on an actual scrambled transmission, heed this warning: **Unauthorized use of a circuit to decode scrambled transmissions may be illegal. This project is not intended for such use. If you wish to use the project to decode such transmis-**

sions, written authorization from the program provider must be obtained first. Do not perform ANY of the following tests without such authorization.

To check out the circuit on a scrambled transmission, connect the decoder between the cable-converter box and the TV's RF input. Set the TV to Channel 3 or 4 as appropriate. Set the converter box to a scrambled channel. Using trial and error, adjust R30 and R31 until the picture locks in. If you have difficulty, also adjust the settings of R21 and L2. It may take some time and patience, but if the circuit is working properly, as verified in the preceding tests, the picture will eventually lock in.

Next time we'll look at a descrambler for the outband system. **R-E**

BUILD THIS

A home or small-business intercom needn't be expensive. Our economical system uses standard pulse-dial telephones, and has options for a PA system—with music!



NINE-STATION INTERCOM

DWIGHT MORRISON

INSTALLING A BUSINESS-TELEPHONE SYSTEM can be an expensive proposition. But if you have several unused pulse-dial telephones lying around, you can use them and cut costs dramatically by building our simple control center (for about \$50). The control center provides a switchboard-like function allowing any one of nine phones to call any other. In addition, one station can be set up as the office PA system; to make an announcement from any station, just dial the station assigned to the PA. The PA system can provide background music (from any source) while no announcement is being made.

System features

Nearly any telephone with a pulse-dial output may be connected to the control center. For example, a standard rotary-dial telephone, a pushbutton phone, a speakerphone, or even a cordless phone could be used. (See this story's lead photo.) Each telephone may be located as far as 2000 feet from the control center; interconnections are made with standard four-conductor 22-gauge telephone wire.

Standard telephone-ring generators require a special 90-volt, 20-Hz power supply. Building such a circuit is expensive as well as difficult because components are hard to obtain. Therefore, the control center generates its own special ring and dial tones.

The control center provides a LIGHT output to illuminate a "busy" LED installed in each station. All LED's light up whenever any station is off hook.

How to use it

Operating the intercom is simple. Pick up the phone at any station; you'll hear a

dial tone in the earpiece, and all LED's will light. Now you can dial any station; while dialing occurs, all of the LED's will flash. After dialing, you'll be able to hear the ringback tone in the earpiece. In addition, the station you dialed will buzz for about one second. If no one answers at that station, you can call again without hanging up.

If someone at a different station picks up his phone, he can join in the conversation. That "party-line" effect can be used for simulating a conference call. For example, if two people are talking and decide that they'd like to include a third, they should hang up, and one should call the third. After giving him time to answer, the one who hung up can pick up his phone and join the conversation.

Circuit operation

The schematic diagram of the control center is shown in Fig. 1. The heart of the circuit is an M-959 IC, manufactured by Teltone (P. O. Box 657, 10801-120th Avenue N. E., Kirkland, WA 98033-0657). The M-959 is a CMOS device that counts dial pulses and provides an encoded binary representation of those pulses. For example, if the digit nine were dialed, the D0-D3 outputs would contain logic levels 10 01. The M-959 also provides a logic-level indication of hook status (OH) at pin 13.

When any station goes off hook, current flows through the coils of relays RY10 and RY11, so their contacts close. Relay RY10 supplies power to the LED's in each station, and relay RY11 grounds the LC (Loop Current) input of IC1. That forces the OH output to go high.

The SR flip-flop composed of IC4-c and IC4-d does not change state, but the

astable oscillator composed of IC5-a and IC5-b turns on because both OH and pin 10 of IC4-c are high. That astable is what provides the dial tone, which is fed to the talk circuit via R12 and C12.

When a digit is dialed, relays RY10 and RY11 "follow" the dial pulses—i. e., their contacts make and break a number of times according to the digit that was dialed. After dialing stops, IC1 places the encoded binary digit on pins 8-11. In addition, IC1's STB output (pin 12) goes high for 200 ms.

There is no station one in this system. The reason is that the circuit cannot distinguish well between going off hook and dialing the digit one. The four gates of IC3 are used to ensure that only stations greater than one are called. Those gates are set up as a three-input OR gate. The inputs of the gate are connected to the D1-D3 outputs of IC1, so any station greater than one will cause the output of IC3-d to go high. That signal is NAND-ed with the STB output of IC1 by IC4-a, and the combined signal is used to trigger IC6, a 555 timer operated in the one-shot mode.

With the component values shown in Fig. 1, the output of the 555 will remain high for about one second. The output of IC4-a also resets the IC4-c/IC4-d flip-flop, thereby disabling the ring generator (IC5-a and IC5-b).

The 555's output (pin 3) enables the astable composed of IC5-c and IC5-d, which oscillates at a frequency of about 1000 Hz. That astable supplies the dial tone, which is fed to the talk circuit via R15 and C12.

In addition, the 555's output is inverted by IC4-b and that signal is used to strobe the binary outputs of IC1 into IC2, a 4-

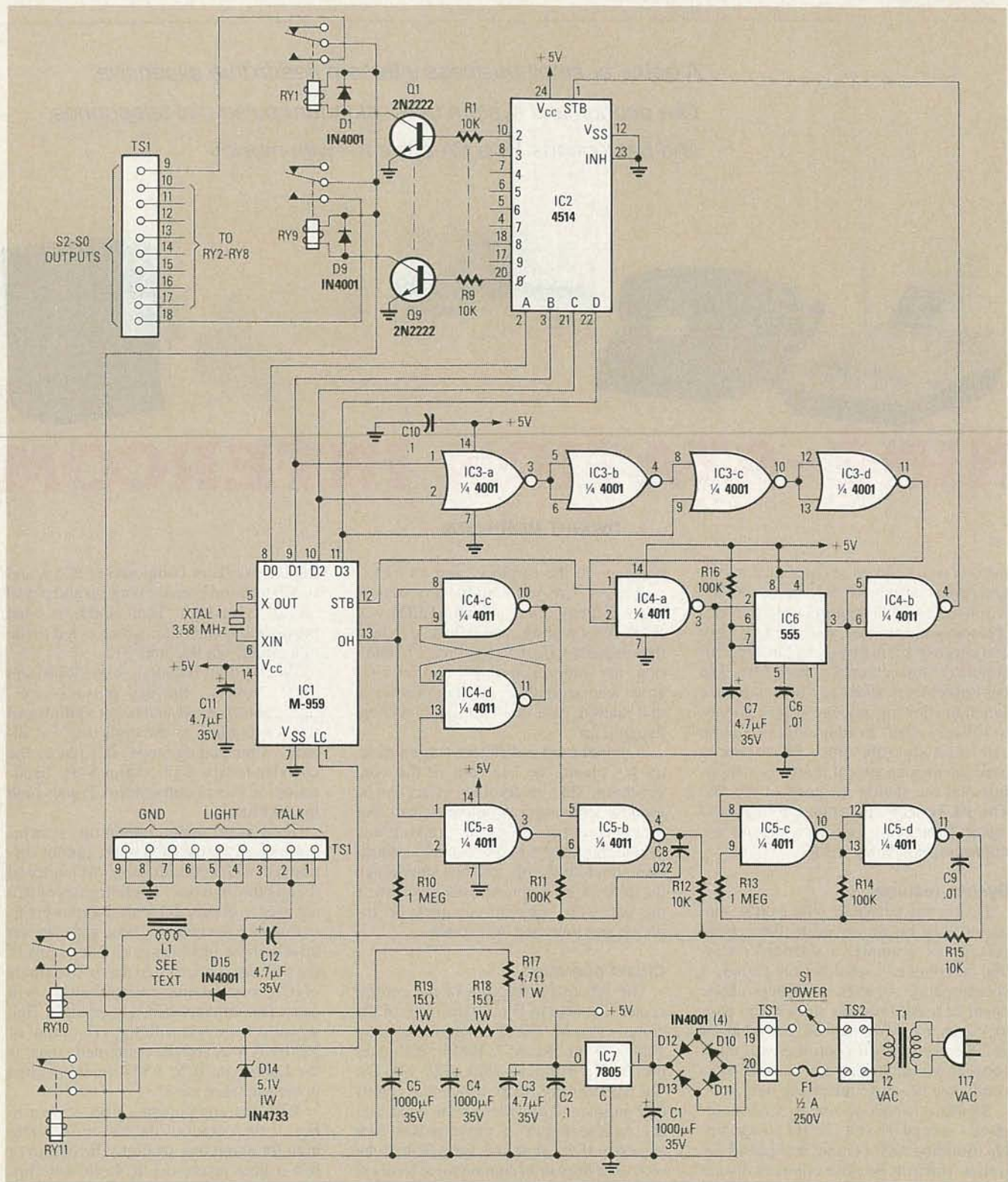

FIG. 1—A-HALF-DOZEN IC'S and a dozen relays comprise most of the circuitry of the intercom. Note that only two of the relay-output circuits are shown (R1-Q1-D1-RY1 and R9-Q9-D9-RY9); the other seven outputs from IC2 are wired in a similar manner.

to-16 line decoder that works as follows. Assume that station two was dialed. Then pin 10 of IC2 will go high and turn on transistor Q1, which will in turn enable relay RY1. At that point, 16 volts will be present at pin 9, the S2 output, of TS1, the 20-terminal strip. That voltage would then

drive the buzzer in station two.

When the conversation ends, both parties hang up. Then relays RY10 and RY11 will de-energize. That will cause all the LED's in the circuit to extinguish, and it will allow IC1's LC input to float high.

Diodes D10-D13 rectify the 12-volt AC

input; IC7, a 7805 regulator provides +5-volts for the logic IC's. Resistors R17, R18, and R19 provide +16-volts to operate the relays and the buzzers. Coil L1, which is actually the primary of a 500-ohm audio transformer, filters power-supply hum from the talk circuit.

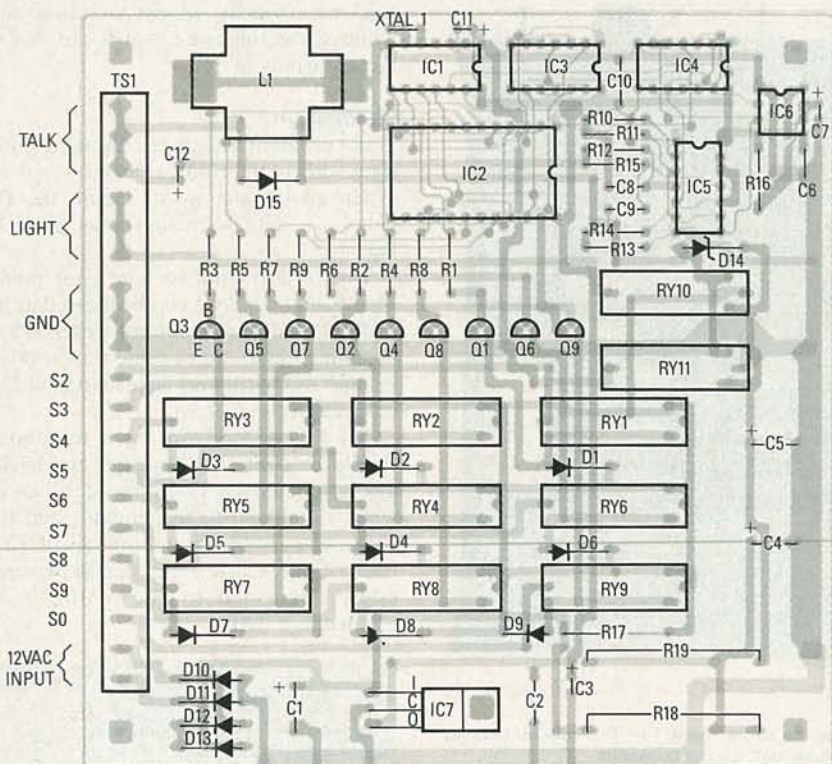

FIG. 2—MOUNT ALL COMPONENTS as shown here. The terminal strip (TS1) is composed of ten dual terminal strips.

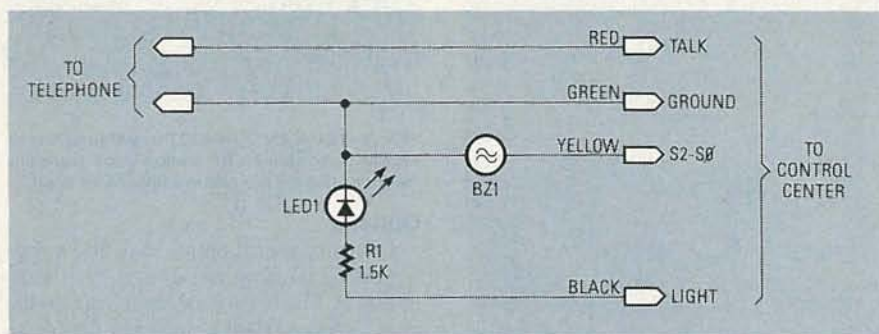

FIG. 3—AN LED, A BUZZER, and a resistor should be mounted in each telephone.

Assembly

Terminal strip TS1 is composed of ten terminal-strip pairs; each PC-board pin and screw terminal is located 0.2" from its neighbor. Radio Shack and Digi-key (P. O. Box 677, Thief River Falls, MN 56701) sell connectors from different manufacturers that will fit the board.

Foil patterns for etching a suitable PC board are shown in PC Service. Beware that the board is double-sided, so, if you etch your own board, you'll have to make provision for soldering all component leads (about 200) on both sides of the board. Alternatively, you can buy a board from the source mentioned in the Parts List. The commercially available board has plated-through holes.

Whether you buy or build your PC board, check it carefully for shorted and open traces before mounting any components. Then, after solving any problems, solder the components to the board ac-

ording to Fig. 2. Mount the low-profile components and IC sockets first.

Don't insert the IC's in their sockets until you perform the initial check-out. The exception is IC7 (the 7805); bend its legs 90° so that it rests flat against the PC board. Secure its tab to the board.

Lay the PC board on a non-conductive surface and connect a 12-volt AC source to the board through a 1/2-amp fuse. Measure the voltage at the input terminal of IC7; it should be about 16-volts DC. The output of IC7 should be between 4.8- and 5.2-volts DC. If those voltages are correct, remove power and insert the IC's in the appropriate sockets.

Testing

You'll need to add a buzzer, an LED, and a resistor to (at least) two telephone sets as shown in Fig. 3. Four wires connect each phone to the control center: three for the talk, light, and ground circuits, and one from each phone to the

PARTS LIST

All resistors are 1/4-watt 5% unless otherwise noted.

R1-R9, R12, R15—10,000 ohms
R10, R13—1 megohm
R11, R14, R16—100,000 ohms
R17—4.7 ohms, 1 watt
R18, R19—15 ohms, 1 watt

Capacitors

C1, C4, C5—1000 μ F, 35 volts, electrolytic
C2, C10—0.1 μ F, ceramic disk
C3, C7, C11, C12—4.7 μ F, 35 volts, electrolytic
C6, C9—0.01 μ F, ceramic disk
C8—0.022 μ F, ceramic disk

Semiconductors

IC1—M-959 dial-pulse counter (Teltone)
IC2—4514 4-to-16 line decoder
IC3—4001 quad NOR gate
IC4, IC5—4011 quad NAND gate
IC6—555 timer
IC7—7805 5-volt regulator
D1-D13, D15—1N4001 rectifier
D14—1N4733 5.1-volt, 1-watt Zener diode
Q1-Q9—2N2222

Other components

F1—0.5 amp, 250 volts
RY1-RY9—reed relay, 12 volt
RY10, RY11—reed relay, 5 volt
L1—500-ohm audio transformer (see text)
S1—SPST toggle
T1—12-volt, 0.5-amp wall transformer
TS1—20-position terminal strip (see text)
TS2—2-position barrier block
XTAL—3.58 MHz, color-burst

Miscellaneous: Enclosure, fuse holder, telephone wire, 12-volt piezo-electric buzzers, LED's, and resistors for telephone stations, etc.

Ordering info

Note: The following are available from COM-TECH, 1856 S. Highland, Jackson, TN 38301: PC board, IC1 (M-959), IC2, and L1, \$34.95; 12-volt, 0.5-amp wall transformer, \$11.95; 12-volt DC latching relay with 3-amp contacts, \$19.95. All orders add \$3 (\$5 Canada) for shipping. Foreign orders must include U. S. funds and \$8.00 for shipping. Tennessee residents add 7% sales tax.

proper s2-s0 output. At the phone end, the red and green wires going to the telephone should connect in parallel with the corresponding wires already in the telephone. The other two wires are connected to the LED and the buzzer as shown.

With power disconnected, connect two telephones to the control center. Apply power, and lift the handset from the base of one telephone. All the busy LED's should light up, and a dial tone should be heard through the handset. Dial the number corresponding to the other telephone. The busy LED's should flash during dialing. After dialing, a ringback tone should be heard over the handset, and the other phone should buzz, both for about one second. Lift the handset from the other phone, if all is well, you should be able to communicate over the two handsets.

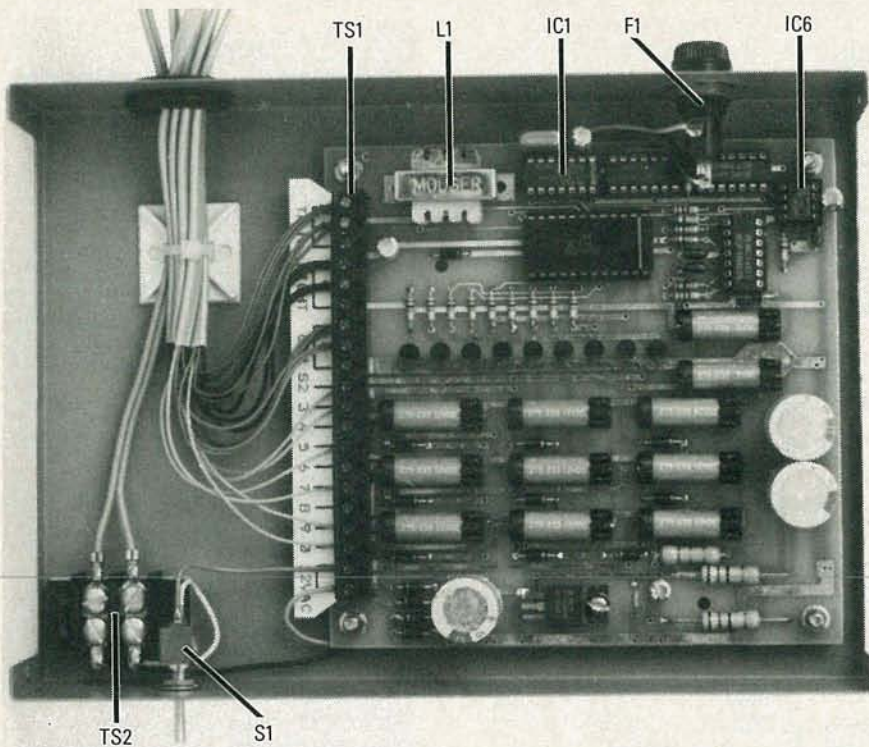

FIG. 4—MOUNT THE PC BOARD, fuse, and power switch as shown here. Run the interconnecting wires through a hole in the rear of the box; insulate the hole with a large grommet.

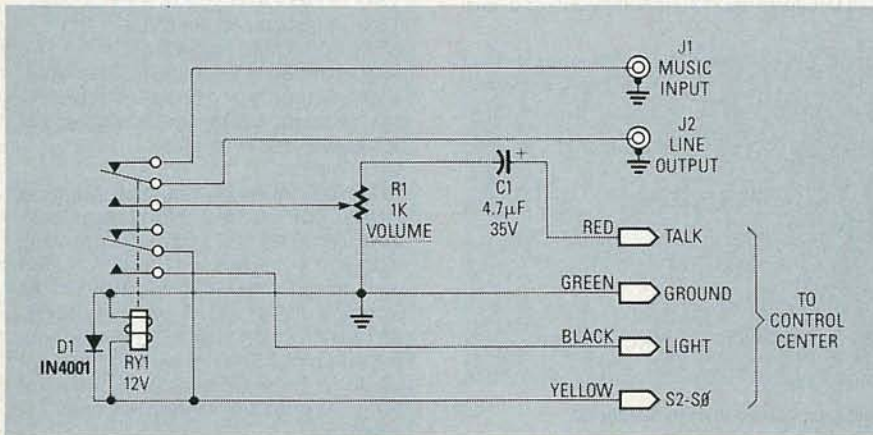

FIG. 5—ADD A PAGING/MUSIC circuit as shown here. Connect the music input to the output of a transistor radio or another suitable source.

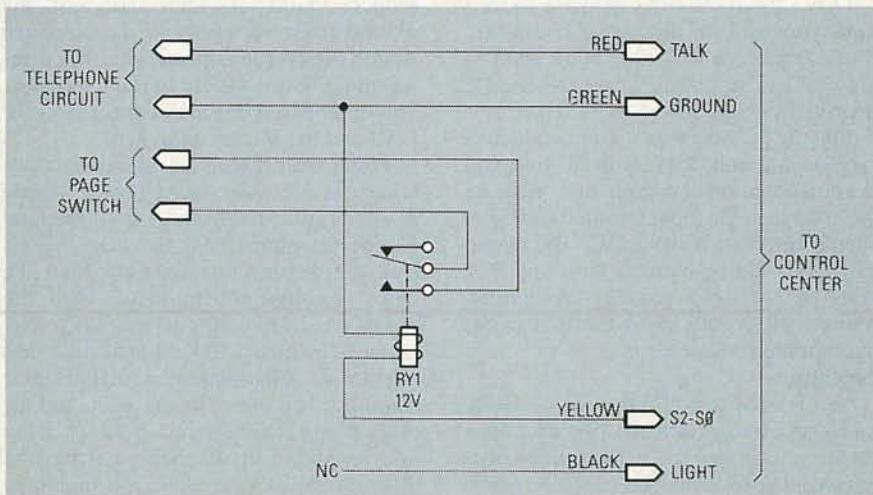

FIG. 6—CONNECT A WIRELESS PHONE as shown here.

To verify that all other channels are working correctly, repeat the above test while connecting one test phone to each of the s_2 - s_8 pins of TS1.

Installation

If a problem is detected during testing, track down the source and correct it. When all circuits work, mount the PC board in a suitable enclosure, as shown in Fig. 4.

Then you'll want to wire your premises. Each telephone can be located as far as 2000 feet from the control center. When installing cable, don't route it near high-voltage AC wiring because hum could be induced in the system.

All red wires from each telephone should be connected together and to the talk terminals of TS1. Likewise, all green wires should go to the ground, and the black wires to the light terminals of TS1. Each of the yellow wires should be separately connected to one of the s_2 - s_8 terminals of TS1.

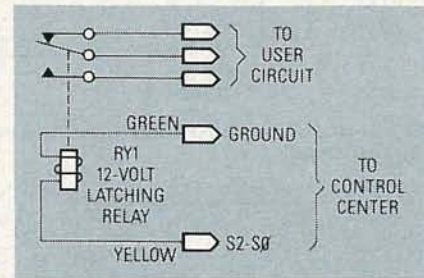

FIG. 7—YOU CAN CONNECT a latching relay as shown here. Dialing its station once turns the relay on; dialing it a second time turns it off.

Options

One very useful option is to add a paging/background music circuit, as shown in Fig. 5. The relay is normally off, so the music source (J1) is connected directly to the line output (J2) through the upper set of contacts. But when that station is called, the relay activates, and the talk circuit is connected to the line output.

The s_2 - s_8 outputs of the control center can be connected to devices other than telephones. For example, you could use one output to activate the "page" feature of a cordless phone. You could page someone carrying a cordless phone by connecting the paging switch in the base station to the control center as shown in Fig. 6.

Another option is to connect a latching relay to one control center output as shown in Fig. 7. Each time the station that circuit is connected to is called, the output of the relay would change state.

There are many other uses for the circuit. For example, you could control the latching relay from a cordless telephone to provide remote control of an electric garage-door opener. Many other uses will doubtless occur to you as you ponder the possibilities!

R-E

THERE HAVE BEEN MANY EXCITING NEW advances in solid-state technology during the past year. Of course, we can't devote the space required to cover them all, but in the next few pages we'll discuss a few of the more exciting, innovative, and useful advances of 1986.

Motorola's Sensefet

The first current-mirror power MOSFET is the newly patented *Sensefet*, made by Motorola (Box 20912, Phoenix, AZ 85036). The new TMOS FET reduces the complexity and increases the efficiency of current-load monitoring circuits. An adaptation of the current mirror is used in the development of a loss-less current sensor. The *Sensefet* is composed of 3600 cells formed on a MOSFET die. Current flowing through two of the cells develops a few microvolts across an external resistor, R_{SENSE} , shown in Fig. 1. A feedback control voltage that is proportional to the total current flowing through the device appears across the resistor; that control voltage can be scaled to determine the total current.

The first *Sensefet* in a planned series of devices is the MTP10N10M. The new device is a 100-volt, 10-amp, 0.25-ohm power MOSFET in a plastic 5-pin TO-220 package. Applications include motor controls, switching power supplies, circuits requiring short-circuit or overload protection, and any application in which you want to monitor load current.

In addition to the conventional gate, drain, and source, the MTP10N10M has a "sense" or "current-mirror" terminal (μ) and a Kelvin source terminal (κ).

True-blue LED

Silicon carbide, a newly developed base material, is used by the Op-

toelectronics Division of Siemens (19000 Homestead Road, Cupertino, CA 95014) in the LDB5410, the first commercially available blue LED. The device operates over a spectral bandwidth of 450 to 540 nm as indicated in Fig. 2.

The LDB5410 is TTL-compatible, pro-

made available in commercial quantities. Several Japanese semiconductor manufacturers have developed blue LED's based on compounds such as silicon carbide, zinc selenide, and gallium nitride. However, fabricating difficulties, inefficient performance, and poor yield of base

materials have made those blue LED's impractical except in specialized applications that have been designed with the devices' limitations in mind.

Mean-green phosphor

Hitachi (1800 Bering Drive, San Jose, CA 95112) has recently developed a unique green phosphor that emits visible green light when excited by infrared rays. Luminous efficiency is approximately four times that of other currently available phosphors of its type. The combination of an infrared LED and the $\text{NaYF}_4:\text{Yb,Er}$ phosphor produces an efficient pure-green LED.

As shown in Fig. 3, with IR excitation, the spectral energy distribution of the new phosphor's emission peaks at 541 nm. The resultant output appears pure green when compared to the broad-spectrum 570-nm peak emission from the conventional GaP green LED's.

It is possible to make a two-color LED by mounting a GaAs:Si infrared diode and a GaAsP red diode close together on a common header and coating it with the $\text{NaYF}_4:\text{Yb,Er}$ phosphor. See Fig. 4. By turning on the infrared LED or the red LED, you would obtain either a green or a red emission. Characteristics of the two-color LED are shown in Table 1.

World's fastest switch

The fastest semiconductor device ever built was demonstrated recently. Scientists at AT&T Bell Laboratories (600 Mountain Ave., Murray Hill, NJ 07974),

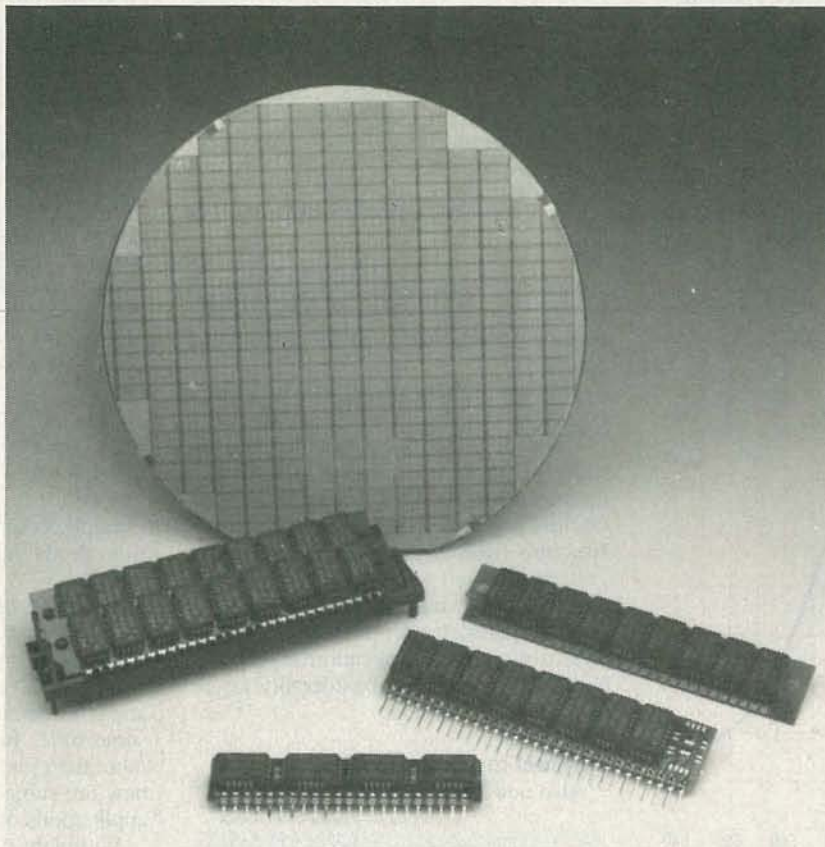

What's New in Solid State

What's been happening in semiconductors the past year? Blue and green LED's, databooks on diskettes, and more.

ROBERT F. SCOTT, SEMICONDUCTOR EDITOR

duces 6 microcandles of light, and subtends a 16° viewing angle. Operating current is 25 mA and forward voltage drop is typically 4 volts. Other characteristics include 150 mW dissipation and 160 pF capacitance. The LED is encapsulated in a 5-mm plastic housing with a clear lens.

A potential drawback is its low reverse-current rating— $0.01 \mu\text{A}$ at 1 volt. Hence it is imperative that the device be connected to a circuit with the proper polarity.

The Siemens offering is not the first true-blue LED, but it is the first to be

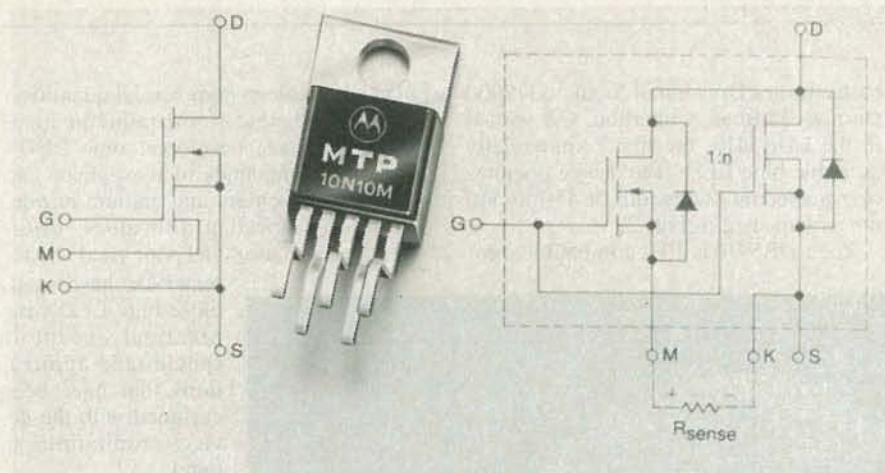

FIG. 1—MOTOROLA'S SENSEFET provides a feedback control voltage that is proportional to the total current flowing through the device.

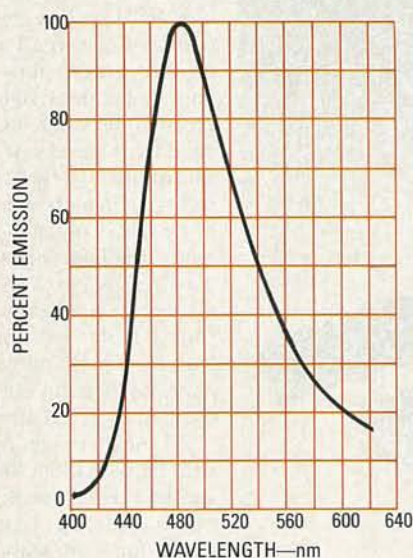

FIG. 2—SIEMENS'S TRUE-BLUE LED has peak output at 480 nm.

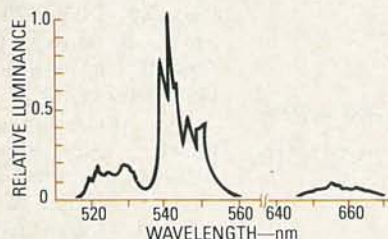

FIG. 3—HITACHI'S PURE-GREEN LED has peak output at 541 nm.

in collaboration with scientists at the National Research and Resource Facility for Submicron Structures (NRRFSS) have designed and fabricated a switch that can turn an electronic signal on and off in 5.8 picoseconds (trillionths of a second). The earlier record for fast switching was 8.5 picoseconds. The new device attains its 5.8-ps speed (the time it takes light to travel one-sixteenth of an inch) in a super-

cooled environment at the temperature of liquid nitrogen—77°K. A near-record 10.2 ps was reached at room temperature (300°K).

The researchers made test structures consisting of ring oscillators and frequency dividers on multilayered wafers of gallium arsenide and doped aluminum gallium arsenide. The basic units in those circuits are Selectively Doped Heterostructure Transistors (SDHT's).

Recently Bell Labs researchers built the largest known SDHT logic device, a 4×4 bit parallel multiplier. It can complete a 4×4 multiplication in 1.6 billionths of a second—considerably faster than other multipliers.

Ultrafast mux/demux IC's

Also new from AT&T Bell Labs is the

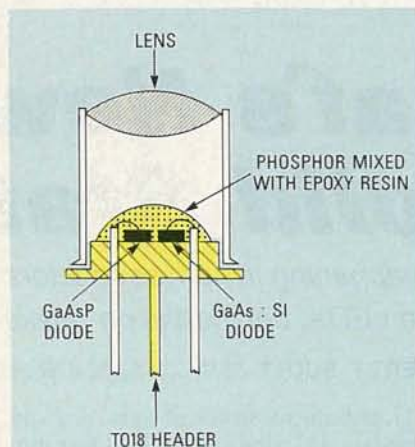

FIG. 4—HITACHI'S DUAL-COLOR (red and green) LED is built as shown here.

fastest practical set of MOS chips for multiplexer/demultiplexer service. Described in a paper delivered at the International Solid State Circuits Conference, the devices were tested at speeds of up to 3 gigabits per second—fast enough for use in high-speed fiber-optic transmission systems. Mr. George Smith, head of the development team says, "Most people consider gallium arsenide the technology of choice for ultra-fast circuits. But what that chip set shows is that silicon can also be used for gigabit-per-second logic circuits. And silicon offers higher yields, lower cost, and higher levels of integration than gallium arsenide."

The multiplexer chip has 200 logic gates and dissipates only 0.5 watt. The demultiplexer has 400 logic gates and dissipates 0.75 watt. Both chips are 2 mm². They are designed in 0.75 micron technology and have channel lengths as short as 0.5 microns. Propagation delay in each gate is only 150 picoseconds, making the devices the fastest in any practical MOS circuit.

The multiplexer accepts 12 parallel input channels, and, using time-division multiplexing, generates a multi-gigabit-per-second serial output. The demultiplexer performs the reverse operation, producing 12 parallel outputs.

New high-speed GaAs arrays

Gallium arsenide has been used as the basis of infrared emitters, reflective sensors, optical couplers, optical switches, and other semiconductor devices for quite some time. Recently GaAs has become more than just a laboratory curiosity; it's now the subject of many experiments in applications other than as a light emitter.

Within the past year, several companies have introduced custom and semi-custom GaAs gate arrays. The new devices are much, much faster than similar silicon-based circuitry. For example, Honeywell's Gallium Arsenide IC Product Center (Richardson, TX) introduced the HGG-2020, a 2000-gate array that clocks at speeds as high as 1 GHz and has 56 I/O cells that are adaptable to work with ECL, TTL, and CMOS signals.

Harris Microwave Semiconductor Division (1530 McCarthy Blvd., Milpitas, CA 95035) has introduced the HMD11100 semi-custom gate array that operates at 3-GHz clock rates and works into 50-ohm ECL loads. It has the equivalent of 300 gates and consists of 8 (each) NOR gates, master-slave flip-flops, and output buff-

TABLE 1—TWO-COLOR LED

Characteristic	Green LED	Red LED
Forward voltage drop	1.3 V	2.0 V
Brightness	250 fL/50 mA	370 fL/30 mA
Power conversion efficiency	0.025%/50 mA	0.25%/30 mA

MAKING NEWS—39 YEARS AGO

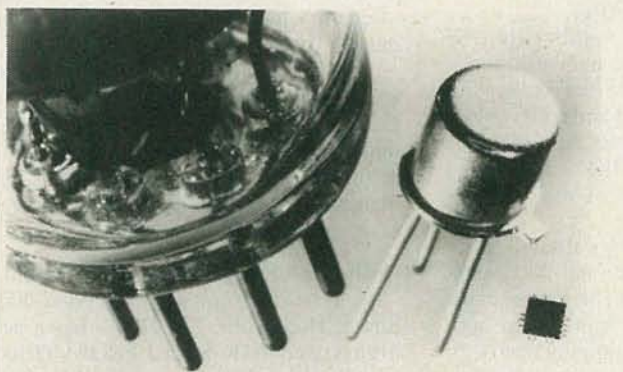

30 YEARS OF ELECTRONICS HISTORY IS represented in this photo; from left to right, a vacuum tube, a transistor, and an early integrated circuit.

On June 30, 1948, Mr. Harvey Gernsback and the author were among a group of science writers and other members of the press that attended a historic press conference and demonstration at the Bell Telephone Laboratories in New York City. The conference was called to announce the invention of the transistor by Drs. John Bardeen and Walter H. Brattain of Bell Labs.

The transistor, as demonstrated, was a revolutionary device; hardly larger than the tip of a shoelace, it could do many of the things a vacuum tube could do, and many other things as well—all with incredibly small amounts of power. Of minuscule size in comparison with the smallest vacuum tube, the transistor is exceptionally rugged. It has no vacuum, no grid, no plate, and no cathode. Further, it has no warm-up delay.

The first amplifying semiconductor was the point-contact transistor. As shown in Fig. 1, it consists of two thin wires spaced only a few thousandths of an inch apart with their ends touching the surface of a thin wafer of germanium. The flow of current in one of the wire points controls the flow of current through the other.

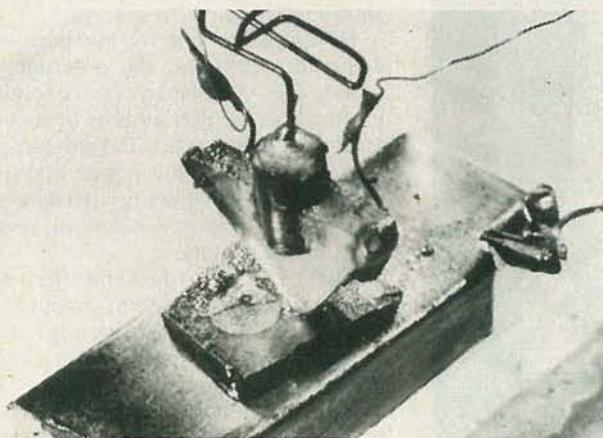

FIG. 1—THE FIRST TRANSISTOR consisted of two thin wires, spaced only a few thousandths of an inch apart, with their ends touching a wafer of germanium.

The next breakthrough from Bell Telephone came in March 1950 with the announcement that Dr. J. N. Shrive had invented a new transistor controlled by light rather than by electric current.

In July of the following year, the junction transistor, invented by Dr. William Shockley, shown in Fig. 2, was announced. It was extremely small for its time, occupying only about $\frac{1}{4000}$ th of a cubic inch, and consumed even less current than the earlier point-contact device.

In the ten years following the invention of the first transistor, the world of the semiconductor did not stand still. Nor did all the

exciting inventions come from Bell Labs. The germanium diode had been invented long before the transistor; the 1N34, 1N60 and



FIG. 2—TWO SEMICONDUCTOR PIONEERS. Dr. William Shockley is shown at the right; Mr. F.E. Blount is at the left.

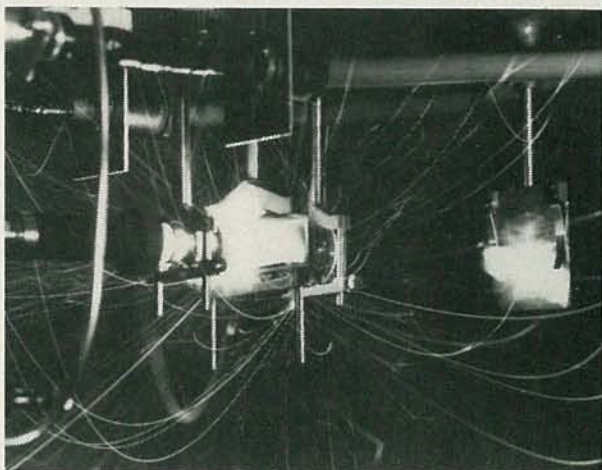

FIG. 3—THIS LASER, developed by Raytheon in the early 1960's, could deliver more than 350 joules of energy.

similar diodes from Sylvania and GE were the latest toys of the electronics experimenter and hobbyist.

The selenium rectifier replaced the copper-oxide tungar rectifiers in battery chargers and low-voltage power supplies. And, pretty soon, the selenium rectifier replaced the rectifier tube in AC-DC radios.

The germanium power rectifier was used for a while, but it was soon pushed aside by the silicon rectifier—a device that has held its place in electronics ever since, both as a small-signal detector and as a power-handling rectifier.

Those (and many other) developments from the early days of semiconductors were not the only things making electronics news. FM, TV, high-fidelity, and the laser, shown in Fig. 3, were all in their infancy then, and scarcely a week passed without the announcement of a new and revolutionary development.

Doubtless, old-timers who followed **Radio-Craft** and **Radio-Electronics** can recount many tales of exciting headline-making advances in electronics.

R-E

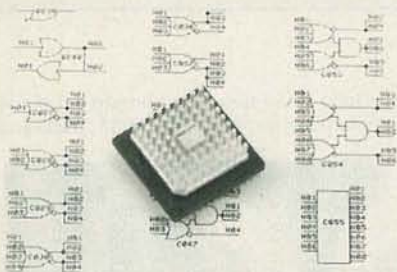

FIG. 5—NEC'S μ PB6350 holds more gates than any other ECL gate array: 5000.

ers; 48 AND gates, 16 input buffers, and 6 differential amplifiers.

Textronix' TriQuint Division (P. O. Box 500, Beaverton, OR 97077) was the first to offer a semi-custom GaAs gate array when it introduced the Q-chip. The device features 2-GHz clock speeds for digital operations and a 6-GHz unity-gain bandwidth for analog functions.

The Q-chip has a total of 52 cells. The 28 internal logic cells each divide into 100 gates; each gate is configured, during the metallization process, to have specific functional characteristics. The remaining

24 peripheral cells are configured as high-speed devices adaptable to interface with ECL, CMOS, or TTL signal levels.

New MOSFET numbering

RCA (Route 202, Somerville, NJ 08876) has changed the numbering system of its popular MOSFET devices to conform to industry standards. Originally designated "RRF" by RCA, the series will hereafter use the "IRF" prefix used by most other makers of that type of MOSFET.

The RCA IRF MOSFET's are drop-in replacements for International Rectifier's HEX1, 11, and 111 sizes. The series spans voltage ratings ranging from 60 to 500 volts with drain currents ranging from 2.5 to 14 amps. The drain-to-source on resistance ($R_{DS(ON)}$) varies from 0.18 ohm at the lower breakdown voltages to 4.0 ohms at the highest breakdown voltage.

High-speed, high-density ECL

NEC Electronics (252 Humboldt Court, Sunnyvale, CA 94086) has introduced a series of ECL gate arrays that offers the highest level of integration cur-

rently available. The μ PB6350, shown in Fig. 5, is the ECL density record-holder with 5000 gates. The runner-up is the μ PB6340 with 4000 gates. Both devices offer ultra high-speed operation: 0.7 ns/gate.

NEC's Director of Gate Array Marketing, Mr. H. Hashimoto, says, "Our new ECL-3A family offers an optimum solution for designers of minicomputers, parallel processors, vector processors, mainframes, IC testers, and high-speed communications equipment."

High-speed, high-density EEPROM

General Instrument (600 West John Street, Hicksville, NY 11802) has a new high-speed 64K-bit EEPROM (Electrically Erasable Programmable Read Only Memory) that is the first of its type to become available. It uses advanced CMOS floating-gate technology in 1.5-micron geometry. Access time is under 150 nanoseconds, compared to the industry average of over 200 ns. And the device's write speed of 200 ms is five times faster than most other currently available devices.

Databook on disk

Siliconix (2201 Laurelwood, Rd., Santa Clara, CA 95054) has revolutionized the method by which design engineers and purchasing agents specify semiconductors with their announcement of the innovative *MOSPOWER Computer Data Book*. The entire catalog is contained on a 5-inch floppy diskette, with search software, that runs on any IBM-PC or PC-compatible machine. The system is shown in Fig. 6.

Designed for use by inexperienced computer operators, the program will search for and display device options given a specific part number or user-entered device parameters. The program also includes an automatic power MOSFET cross-reference showing alternate part numbers for components from several other manufacturers.

All the user has to do is enter the device parameter limits. Within seconds, the computer data book displays a list of optimum devices along with their characteristics and package options. The *MOSPOWER Computer Data Book* is free to Siliconix customers.

Semiconductor makers unite

Westinghouse's Semiconductor Division (Armbrust Road, Youngwood, PA 15697), GE's Thyristor Products Operation (W. Genessee St., Auburn, NY 13021), and Mitsubishi Electric America (777 N. Pastoria Ave., Sunnyvale, CA 94086) have begun a new joint venture to manufacture and distribute power semiconductors. The name of that venture is Powerex, Inc. Contact them at Hillis St., Youngwood, PA 15697.

R-E



FIG. 6—SILICONIX' MOSPOWER DATABOOK fits, with search software, on a single 5¼" IBM-PC diskette.

How to

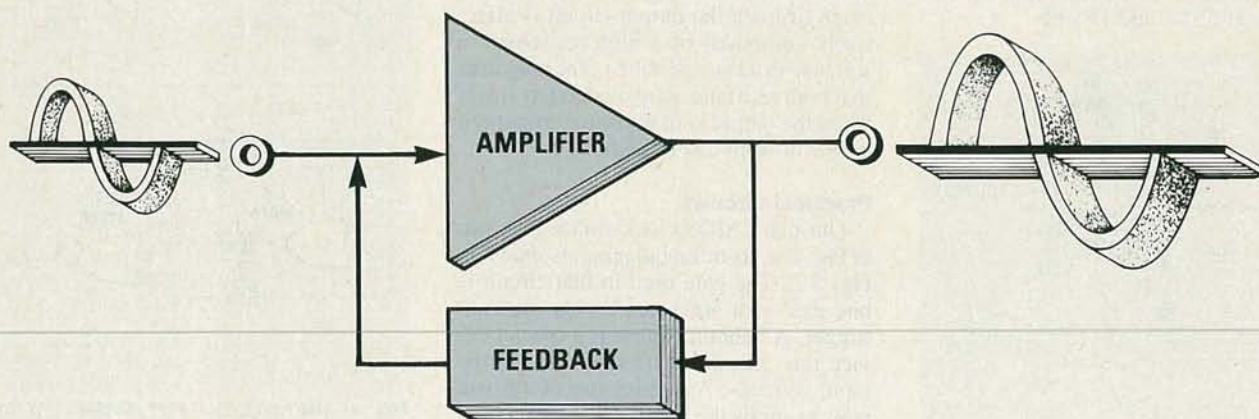

Design OSCILLATOR Circuits

JOSEPH J. CARR

Our oscillator series concludes with a discussion of CMOS oscillators.

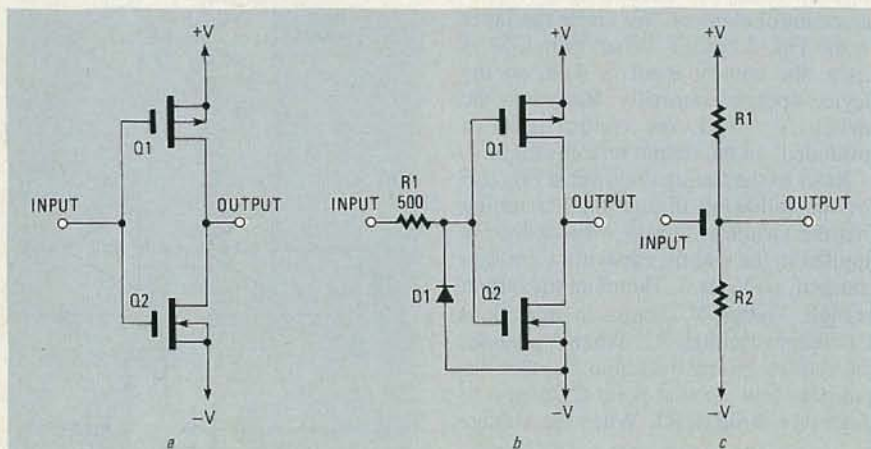

FIG. 1—TYPICAL A-SERIES CMOS INVERTER uses complementary MOSFET transistors (a); the B-series adds diode and resistor input protection (b). The equivalent circuit may be thought of as two gated resistors (c).

Part 7 FOR OUR FINAL installment, we'll discuss the digital CMOS oscillator. Like its TTL counterpart, the CMOS oscillator is often used as a clock in digital circuits. There are several significant differences between TTL and CMOS devices, however.

Perhaps the biggest difference is that CMOS devices are made from Metal Oxide Semiconductor Field Effect Transistors (MOSFET's) rather than the bipolar types used in TTL devices. MOSFET's draw considerably less current than TTL devices (microamperes rather than milliamperes). However, a

standard CMOS device has a lower maximum operating frequency than a functionally equivalent TTL device.

Figure 1-a shows the CMOS inverter that is the basis of many gates and larger logic elements. The inverter shown there consists of a pair of MOSFET transistors; that type of inverter is the core of the older A-series CMOS devices.

Transistor Q1 is a p-channel MOSFET, and Q2 is an n-channel MOSFET. Those devices operate as follows: A high applied to the common input terminal causes Q2 to turn on and Q1 to turn off. Therefore, the output is low. Likewise, a low input

causes Q1 to turn on and Q2 to turn off, so the output is high.

The newer B-series type of CMOS gate is shown in Fig. 1-b. It contains several components that protect the device from ElectroStatic Discharge (ESD). A-series devices have a gate breakdown voltage of less than 100 volts. Since static build-up on clothing and tools can reach several kilovolts easily, you can damage an A-series CMOS device just by touching it. The resistor (R1) and the diode (D1) in a B-series gate protect against damage by ESD.

There are other differences between A- and B-series CMOS devices. The B series offers faster rise and fall times, and they will drive larger loads than most A-series counterparts. And, although there may be some applications where the characteristics of the A-series are advantageous, in general the B-series device is preferred.

The first CMOS devices had part numbers in the 4000 series. Later, designers wanted pin-compatible substitutes for 74-series TTL devices, so the 74C series came into being. However, although the pinouts of 74 and 74C devices are identical, the electrical characteristics of TTL and CMOS are very different. So, for example, you can't plug a 74C04 package into a circuit designed for use with a 7404. However, a new series of CMOS devices, the 74HCT series, is plug-compatible with LS-type TTL devices.

CMOS devices operate from two power supplies, +V and -V. The difference between the two must generally be less than 18 volts. For example, +12 volts and -6 volts, or ± 9 volts, etc. Of course, +V is often set at +5 volts and -V at 0 volts (i. e., ground). The operating characteristics of CMOS devices vary with supply voltage; for that reason, manufacturers often specify operating characteristics at 5, 10, and 15 volts.

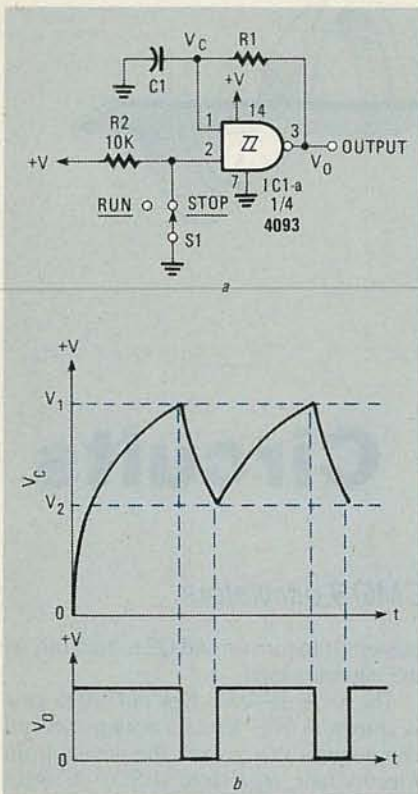

FIG. 2—AN ASTABLE MULTIVIBRATOR may be built from a 4093 Schmitt trigger (a); the circuit's timing is shown in b.

Circuit model

The transistors in the CMOS device can be modeled as gated resistors, as shown in Fig. 1-c. In that circuit the channel resistance of the n-channel device is represented by R1, and the channel resistance

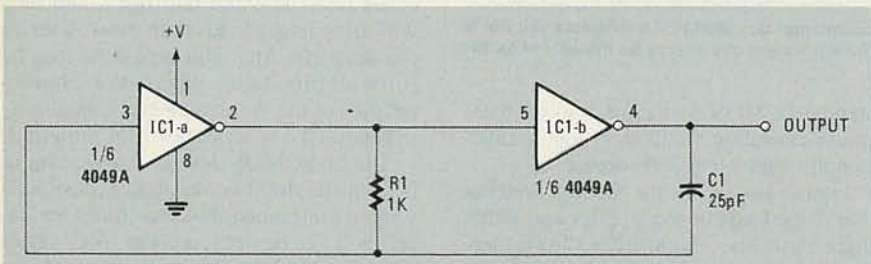

FIG. 3—A PAIR OF CMOS INVERTERS form a simple oscillator. Oscillating frequency is approximately $1/(2.2 \cdot R1 \cdot C1)$.

of the p-channel device is represented by R2. The output is at the junction of the two resistances.

Let's look at what happens when a signal is applied to the circuit. Assume that

+V is 5.0 and that -V is 0.0 volts. When the input is low, the output is high. In that case, resistor R1 has a low value (less than 2K) and R2 has a high value (1 megohm). But when the input is high, the resistances reverse: R1 has high resistance and R2 has low resistance, so the output is effectively at ground.

CMOS current drain is so low because, whenever the circuit is in a stable state (high or low), the output circuit is effectively composed of a high resistance in series with a low resistance. The only time that both resistances are moderately low is when the output is in transition from high to low or from low to high.

Practical circuits

Our first CMOS clock circuit is shown in Fig. 2-a; its timing diagram is shown in Fig. 2-b. The gate used in that circuit is one gate of a 4093 quad NAND Schmitt trigger. A Schmitt trigger is a special device that changes state only on specific input voltages. Assuming use of a 5-volt power supply, the inputs are affected only by positive-going signals that surpass 2.9 volts, and by negative-going signals that go below 2.3 volts. The hysteresis provided thereby allows you to obtain a squarewave output from a slowly changing input signal.

The gate we use has two inputs, so we could tie both together, effectively forming an inverter, or we could use one input as a control element. We chose the latter in the Fig. 2 circuit. When switch S1 is open, the control input is high, so the device operates normally. But when the switch is closed, the control input is grounded, so the output remains high.

Refer to the timing diagram in Fig. 2-b for the following discussion. Assuming that the switch is closed, when power is applied to the circuit, capacitor C1 is discharged, so V_C is 0. Therefore the output is high. Voltage V_C begins to increase as C1 charges through R1. When V_C passes the positive-going threshold V_1 , the output goes low. At that point C1 begins to discharge through R1. When the voltage

decreases to V_2 , the output again snaps high, and the cycle repeats.

A CMOS oscillator built from a pair of inverters is shown in Fig. 3. The operating frequency of the circuit is approximately:

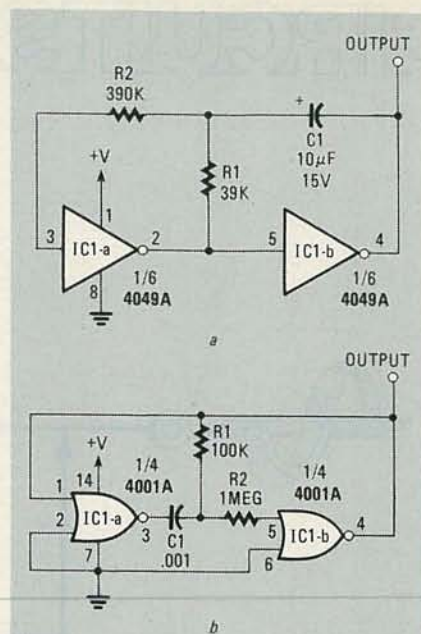

FIG. 4—IMPROVE OUTPUT SYMMETRY by adding an isolation resistor (R2 in both a and b).

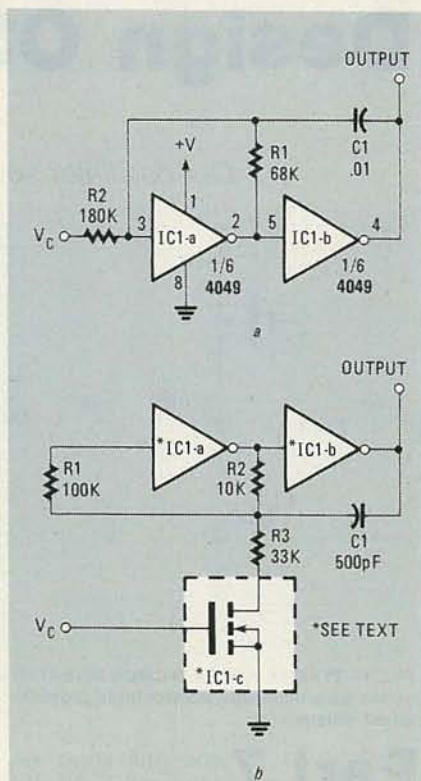
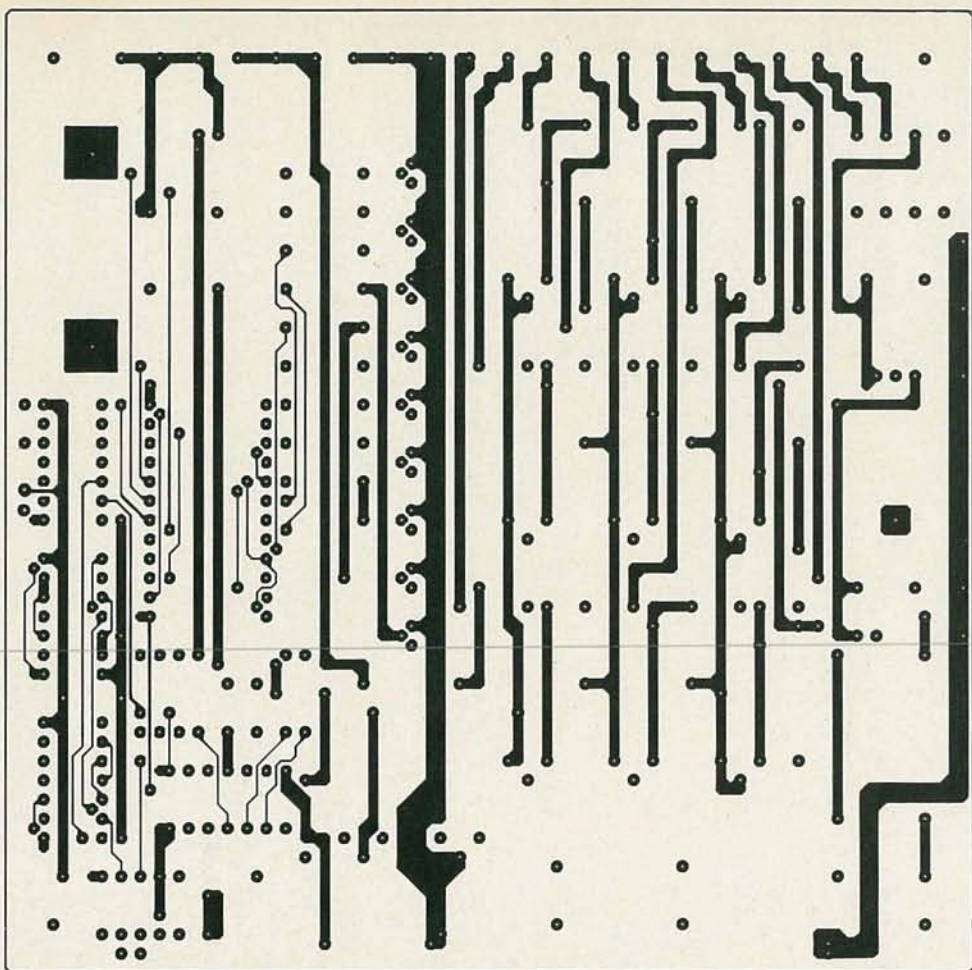

FIG. 5—A CMOS VCO can be built from several standard gates (a) or from a 4007 (b).

$$f = 1/(2.2 \cdot R1 \cdot C1)$$

The value of R1 can range from the value shown to several megohms; the value of C1 can be as high as 10 μ F.

The output waveform of that circuit is slightly asymmetrical, especially when B-series devices are used. The problem with the B-series device is that the internal *continued on page 70*



5 INCHES

One of the most difficult tasks in building any construction project featured in **Radio-Electronics** is making the PC board using just the foil pattern provided with the article. Well, we're doing something about it.

We've moved all the foil patterns to this new section where they're printed by themselves, full sized, with nothing on the back side of the page. What that means for you is that the printed page can be used directly to produce PC boards!

Note: The patterns provided can be used directly only for *direct positive photoresist* methods.

COMPONENT SIDE of the telephone intercom.

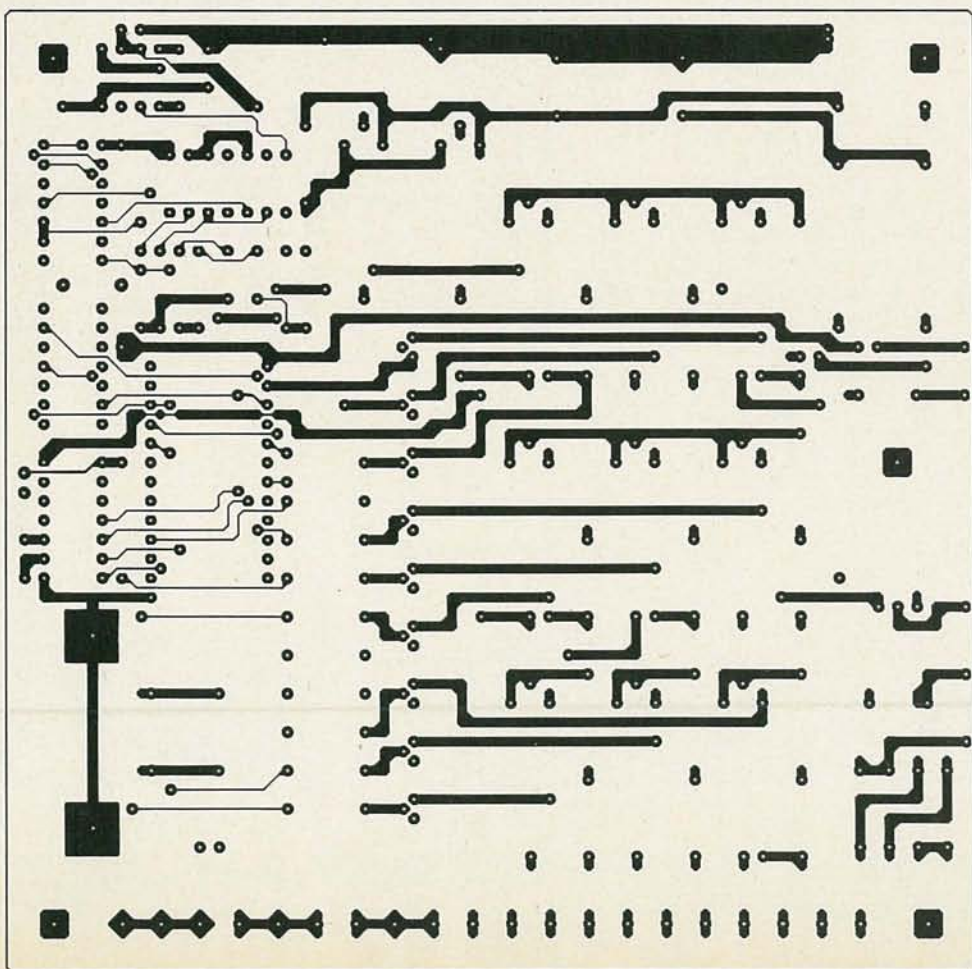

5 INCHES

SOLDER SIDE of the telephone intercom.

PC SERVICE

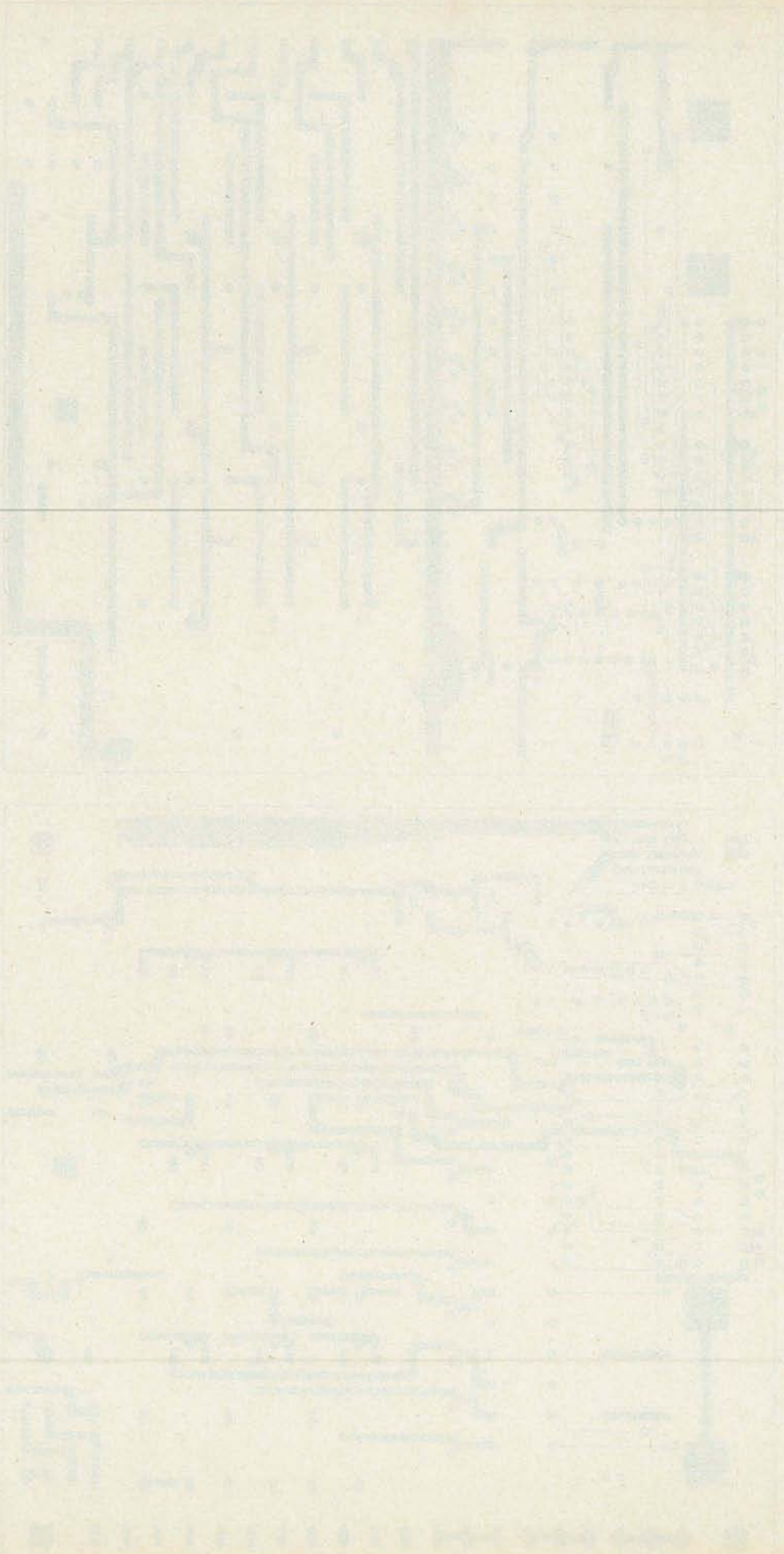

R-E ROBOT

continued from page 44

nate those problems, the bus connectors were modified to afford a more streamlined package. The fully buffered bus is daisy-chained to peripheral boards through mass-termination headers. Other buses can be supported as well, and simple adapters convert the bus connector to STD, iSBX or S100 standards. Peripherals designed for the VME, Q-BUS, and Multi-bus standards can be accommodated as well.

Designing the software

The key design requirements of the BIOS are twofold: First it must support the on-board functions of the terminal, auxiliary RS-232 communications, real-time clock, disk storage, and printer. Second, it must be able to boot MS-DOS applications software to capitalize upon the wealth of development tools available for the PC. The BIOS for the system is contained in a separate ROM and performs the same functions as the PC BIOS wherever possible. Due to the selection of a terminal as the operator I/O device, many graphics functions are not possible. Present day terminals fully support cursor-ad-

dress functions, so that limitation is not as overwhelming as might be imagined. The BIOS performs admirably for applications-program development.

Several constraints must be met by the system software. The system must support minimal applications with an on-board stand-alone language in ROM, much as the PC does with Cassette BASIC. The logical choice is BASIC, because if the application is minimal, BASIC will probably suffice. Stand-alone BASIC will require that the terminal interface have the ability to read and write to disk and support all of the on-board functions. We wrote an integer BASIC interpreter to support the board and we stored it in a 16K ROM. We wrote the BASIC interpreter on a PC using standard BIOS calls to communicate to the operator. Using a PC as a development tool allowed direct transport of the BASIC when the hardware development of the circuit board was complete. We then installed that interpreter in the system during development and used it to test the remainder of the system.

Due to the popularity of Forth in control applications and the ease of installation of the Forth package, a version of Forth was also altered and installed in ROM on the system. The advantages of Forth were discussed in Part I of this article (**Radio-**

Electronics, December 1986). Its disadvantage is the obscure nature of the language. Once your application is coded in Forth, it will be yours forever and you will probably not find another programmer to maintain it.

The actual development of high-level applications code in either of the two languages is very simple. Attach the terminal to the RS-232 port and select the EPROM containing the chosen high-level language. Enter the applications program into RAM and test it. Copying the program into EPROM is then simply a matter of executing the PROGRAM statement in either language. Alternatively, the program can be left in RAM. The battery will support the RAM during transport and field installation. That feature is required for programs written in some disk-based languages that are not designed for ROM.

Developing applications software under PC-DOS is also easy. The system behaves exactly like a PC, allowing development of application software in a wide assortment of languages. At this point, we have experimented with C and Pascal, and find that they run acceptably. Utilities in ROM allow easy use of the on-board EPROM programmer, so any .COM file can be easily stored in ROM.

Next month we will highlight the construction of the robot's base unit. **R-E**

APPLY FOR A PATENT

continued from page 52

references must be to the labels shown in the drawing.

Best Mode of Carrying Out the Invention contains a short and specific description of the best way to get the invention to work correctly. Where elements or processes are generally widely known, they should not be described in detail; but if the invention requires something special, and the examiner might need background information, refer to another patent or to a publication for a description.

Claims

The claims comprise the core of the application because it's here that we distinctly point out the subject matter regarded as the invention.

Ten claims are allowed, each numbered and each separate and distinct from the others. Within each claim, only one distinct characteristic is allowed.

The more general the claim, the more likely that the examiner will reject it, because the chances of interfering with another patent increase as you expand the scope of your invention.

While we must make the claim specific, we must also take care not to make the claim *too* specific. If we were to list a part

FURTHER READING

"Code of Federal Regulations #37, Patents, Trademarks, and Copyrights," Washington, D.C.: Superintendent of Documents, U.S. Government Printing Office

"Information Concerning Patents," Washington, D.C.: U.S. Department of Commerce, 1983

"Attorneys and Agents Registered to Practice Before the U.S. Patent and Trademark Office," Washington, D.C.: Superintendent of Documents, U.S. Government Printing Office

MacCracken, Calvin D., "A Handbook For Inventors," Scribner and Sons, 1983

Sanderson, William R. "Patent Your Invention and Make It Pay," Grosset and Dunlap, 1966

Pressman, David "Patent It Yourself," McGraw-Hill, 1979

number for the SCR, or a value for the resistor, anyone could sidestep the patent's protection merely by substituting a different SCR or resistor value.

Spend the time required to compose your claims properly. Make sure that the claim explains the *concept* that you want to protect.

Abstract

The abstract summarizes the invention and should be contained on a separate page, following the claims. Make sure that the text conveys enough information so that anyone can quickly get the gist of the idea. Edit ruthlessly and delete any unnecessary words. Financing might result from someone reviewing the abstract when your patent is published in the "Official Gazette."

Submitting the application

Once your application is ready, photocopy it. Keep the original and one copy in a safe place and mail a copy to the Office of the Commissioner, Patent and Trademarks Office, Washington, DC, 20231. Enclose a check or money order for \$150. (Note that that is half the \$300 fee that large corporations must pay.)

When the application is processed, the results of the examiner's analysis will be mailed to you. You will have six months to respond, after which the patent will be considered abandoned. If you do manage to secure a patent grant, there will be some additional fees to pay. The fee for issuance is \$250. There is also a \$50/year fee to keep the patent in force. Those fees are payable in \$200 installments in the fourth, eighth, and twelfth years. But if your invention nets you the success you have been dreaming about, you won't mind the cost of patent protection. **R-E**

HAMEG

Instruments

high quality at low cost



Analog
Oscilloscopes

Digital
Oscilloscopes

Multimeters

Counter
Timers

Signal
Generators

Power
Supplies

Scope
Testers

Checkpoint
Testers

Write or call

toll free 800.247.1241

HAMEG, INC.

88-90 Harbor Road · Port Washington N.Y. 11050
Phone (516) 883.3837 · TWX (510) 223.0889

THIS SPACE CONTRIBUTED AS A PUBLIC SERVICE

**When someone
in your family
gets cancer,
everyone
in your family
needs help.**

Nobody knows better than we do how much help and understanding is needed. That's why our service and rehabilitation programs emphasize the whole family, not just the cancer patient.

Among our regular services we provide information and guidance to patients and families, transport patients to and from treatment, supply home care items and assist patients in their return to everyday life.

Life is what concerns us. So you can see we are even more than the research organization we are so well known to be.

No one faces cancer alone.

AMERICAN CANCER SOCIETY

Employers

Willing workers available now at as little as 1/2 your usual cost.

This is your chance to get help you've needed, but thought you couldn't afford.

No business too large or too small. Call your private industry council or write National Alliance of Business, P.O. Box 7207, Washington, D.C. 20044

A Public Service of
This Publication

Ad
Council

OSCILLATORS

continued from page 66

diode protection causes unequal charge and discharge paths. To equalize those paths, some means must be provided of isolating the R1/C1 circuit from the input. The circuits shown in Fig. 4-a and Fig. 4-b show several methods of providing that isolation. Resistor R2 in both cases separates the RC network from the diode-protected input, thereby curing the symmetry problem in the output waveform.

Variable-frequency oscillators

A pair of VCO's (Voltage Controlled Oscillators) are shown in Fig. 5-a and Fig. 5-b. The frequency at which each circuit oscillates depends in part on the value of the voltage (V_C) applied to its control input. In Fig. 5-a, that voltage biases the input of the inverter and the junction of the RC network to a static value. The charge/discharge cycle then takes a longer or a shorter time depending upon the applied voltage. The base frequency of oscillation (when $V_C = 0$) is found according to the formula mentioned earlier.

The circuit in Fig. 5-b works a little differently. It is built from a 4007 device, which contains a number of uncommitted MOS transistors. (See "The Versatile 4007" in the September 1986 issue of *Radio-Electronics*—Editor) In that circuit, IC1-a and IC1-b form the basic oscillator, and IC1-c shunts the RC junction to ground, thereby affecting charge/discharge timing. The control voltage is applied to the gate of MOSFET transistor IC1-c.

CMOS PLL VCO

The circuit shown in Fig. 6 is built from

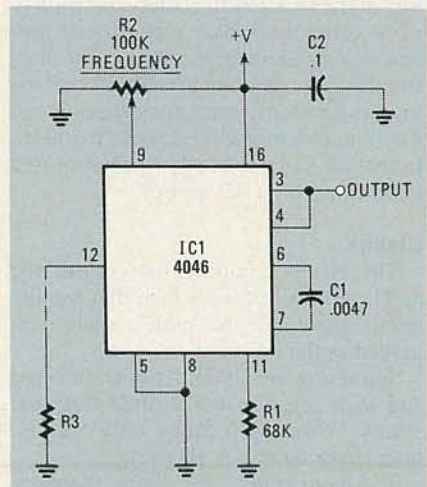

FIG. 6—THE VCO SECTION OF A 4046 can also be used to build a variable-frequency oscillator.

the VCO section of a phase-locked loop. The control voltage is applied to pin 9; in that circuit, potentiometer R2 allows you to vary frequency manually. The circuit's

continued on page 84

EQUIPMENT REPORT

continued from page 25

the keyboard. With the recognition macros and the customizable command template, your hand never has to leave the *Penpad*. And that makes drawing, erasing, copying, zooming, panning, etc., an order of magnitude easier. In short, using AutoCAD (or any program supported by Pencept) without a *Penpad* is like drawing without a straightedge. We recommend it highly.

The *Penpad 320* lists for \$1495 with one application (Pencad, Pen-draw, or Penform). The applications list separately for \$195 each. Extra pens list for \$175. **R-E**

Beckman Industrial DM 800 DMM

A 4½-digit DMM for the
hobbyist or professional.



CIRCLE 10 ON FREE INFORMATION CARD

OVER THE YEARS, BECKMAN INDUSTRIAL'S (630 Puenta Street, Brea, CA 92621) Circuitmate line has offered top-notch test equipment at a reasonable price. That tradition is continued in two recent additions to Beckman's line. Those additions are the model *DM 800* and the model *DM 850* DMM's. The units are identical except in one respect: The model *DM 800* is an average-sensing meter, while the model *DM 850* reads true rms.

The *DM 800*

We received a sample of the *DM 800* for our review. Therefore, all of our comments are based on our evaluation of that unit. However, except as noted, all specifications apply to both units.

The model *DM 800* is a functional, no-nonsense unit. It lacks some of the features found on more costly units, such as auto-ranging, but makes up for that with low-cost and solid performance.

One feature that is included is a 4½-digit LCD readout. That allows for high resolution on all measuring ranges. Further, there is a frequency measurement function that allows the meter to double as a 200-kHz frequency counter, as well as a data-hold function. There are also the obligatory audible continuity-test and diode-test functions.

All measurement ranges are selected using the large rotary switch that dominates the front of the instrument. DC voltage is measured in five ranges, from 200 mV to 1000 volts, full scale. Levels as low as 10 µV can be measured. Accuracy is specified as ±0.05% of reading ±3 digits.

AC voltage (average sensing for the model *DM 800*, true rms for the model *DM 850*) is also measured over five ranges, but the top range is 750 volts, full scale. Except

Beckman	800 DMM									
OVERALL PRICE	1	2	3	4	5	6	7	8	9	10
EASE OF USE	1	2	3	4	5	6	7	8	9	10
INSTRUCTION MANUAL	1	2	3	4	5	6	7	8	9	10
PRICE/VALUE	1	2	3	4	5	6	7	8	9	10
	<div style="display: flex; justify-content: space-between; width: 100%;"> Poor Fair Good Excellent </div>									

for the top range, accuracy depends on frequency. It varies from ±0.75% ±10 digits (40 Hz–1 kHz) to ±6.0% ±30 digits (2 kHz–5 kHz). On the top range, the accuracy is specified as ±1% ±10 digits at frequencies up to 5 kHz. If the AC accuracy seems low, remember that we are dealing with a 4½-digit unit.

AC and DC current is measured

over six ranges, from 200 µA to 10 amps, full scale. Currents as low as 10 nA can be measured. For the DC ranges, accuracy is specified as ±0.3% ±3 digits to 200 mA. On the 2- and 10-amp ranges, accuracy is specified as ±0.75% ±3 digits. For the AC ranges, to 200 mA the accuracy is specified as ±0.75% ±10 digits for frequencies less than 400 Hz; at higher frequencies it is ±0.75% ±20 digits. On the 2- and 10- amp ranges, accuracy is specified as ±1.2% ±10 digits.

Resistance is measured over six ranges, from 200 ohms to 20 megohms, full scale. Resistance as low as 0.01 ohm can be measured. The 2K range is also used to perform the diode test function.

The continuity test can be used on all resistance ranges. The threshold level is generally 10% of the selected range. The continuity test is selected by a front-panel DATA-HOLD/BUZZER switch. The test provides both audible and visual indications of continuity.

The DATA-HOLD/BUZZER switch is also used to activate the data-hold function. To freeze a voltage or current reading on the display, the DATA-HOLD/BUZZER switch must be placed in the ON position before the test leads are removed from the circuit under test.

The 200-kHz frequency-measurement function is obviously of limited utility. However, it is better than no frequency-measurement capability at all, and there will doubtless be many instances, especially in the field, where that function will prove to be valuable.

The unit is supplied with a pair of test leads, spare 2-amp fuse, battery, and instruction manual. The unit is powered by a single 9-volt battery.

The tri-lingual (English, German, French) instruction manual is nothing special, but it gets the job done. It provides instructions for using the meter, specifications, and detailed calibration information. A schematic and parts list is also supplied.

It may be a bit short in the bells-and-whistles department, but it is long when it comes to performance and value. The model *DM 800* lists for \$169.95; its sister unit, the true-rms-reading model *DM850* sells for \$219.95. **R-E**

AUDIO UPDATE

Signal processors, part 1

THERE SEEMS TO BE CONSIDERABLE confusion among audio consumers (and salespeople) as to the relative roles and goals of various types of signal processors. The questions go something like this: "I own a cassette deck and have been told that I shouldn't add an equalizer to my system because it will interfere with the deck's Dolby circuits. Will it?"

Or "Since I already own an equalizer, is it worthwhile to add a dbx expander to my system?"

Or "Can I use a Dolby surround-sound decoder on any program material?" And so forth.

Many questions reflect additional confusion about what the contemplated signal-enhancing accessory is meant to accomplish, and sometimes even betray a lack of knowledge about a unit already owned. So before we get into the specifics of each type of processor, it's worth discussing the purposes of different types of signal processing as an aid to sorting out the components and circuits involved.

Nature of the imperfections

Among the most dedicated audiophiles—the ones who are willing to pay extra dollars *not* to have bass and treble controls in their equipment—the very concept of signal processing is somehow sacrilegious. For them, it's as though the program material as delivered by disk or tape were pure, the electronics that handles it noise-free and distortionless, and their speakers and room at all times delivered a totally balanced, flat signal to their ears. Personally, I would find it easier to believe in the Tooth Fairy.

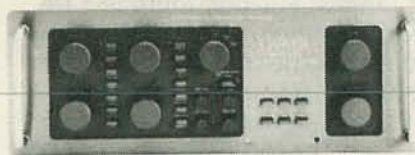

So, given the fact (and it *is* a fact) that in this imperfect world the music that an audio system delivers to the listener's ears is also imperfect, what can be done to bring it closer to our heart's desire? The major audible trouble areas for audio reproduction are *Noise, Dynamic Range, Frequency Range and Balance, and Imaging*. I suspect that some of the marketplace confusion about signal processors probably arises because, except for imaging, there is an interrelationship among the various factors. Help in one area will often have a beneficial effect in another area.

Noise reducers

The designers of noise-reduction circuitry all face the same problem: how to disentangle the signal from the noise sufficiently to be able to suppress the one with minimal effect on the other. Most of the noise that troubles listeners is in the high-frequency area (say, upwards of 4 kHz) and is perceived as hiss. When there is little or no signal above, say, 5 kHz, then a very sharp cutoff filter (perhaps 18 dB per octave) located at the correct frequency could eliminate most of the noise with minimum damage to the music. But the high-frequency filters (they used to be called "scratch" filters) found on most amplifiers aren't worth the panel space they occupy. Because



LARRY KLEIN,
AUDIO EDITOR

of their slow rolloff and poor choice of cutoff frequency, they control hiss about as effectively as the cut side of a treble tone control. One of the very few effective *non-dynamic* high-frequency filters is found in the Quad Model 44 preamplifier; it provides virtually a textbook example of the proper way to design a high-frequency audio filter.

I use the term *non-dynamic* to differentiate between passive filters that apply fixed amounts of attenuation at selected frequencies, and "smart" filter circuits (such as DNR and Carver's "auto-correlator," used in the model C4000, shown in Fig. 1) whose specific moment-to-moment filter action is determined in large measure by the audio signal itself. In general, dynamic filters rely on a psycho-acoustic phenomenon called *masking*, whereby hiss, for example, becomes inaudible in the presence of louder program material at nearby frequencies.

At such a time the dynamic filter switches itself out of the circuit. However, when there is little or no masking high-frequency signal present, the filter cuts in and provides a worthwhile hiss reduction with little audible effect on the highs in the signal. The Carver circuit operates in much the same way, except that its sensing/filtration action operates simultaneously in three separate frequency bands. It can provide about 10 dB of noise reduction with a minimum of unwanted side effects such as "noise pumping" and high-frequency losses.

Many consumers are confused about the differences between the

"one-step" dynamic filters—such as DNR, which will work with any program source (tape, disc, or FM), and the noise-reduction systems that require previous encoding of the program. Dolby B and C and dbx all operate by encoding the program *before* it is recorded and then decoding it during playback. Recording-induced tape noise is reduced by about 10 dB for Dolby B, 20 dB for Dolby C, and more than 40 dB for dbx Type II.

If you play a Dolby B tape without Dolby B decoding, it sounds as if it has a slight high-frequency boost. Dolby C tapes played with Dolby B decoding sound about the same as Dolby B played without decoding, and neither Dolby C nor dbx are suitable for listening without decoding.

Dbx has an additional advantage for the recordist: It extends the dynamic range of his deck to 100 dB or so, meaning that tape-overload problems are virtually eliminated—and that brings us to our next topic.

Dynamic-range enhancers

The most well-known products in this category are made by dbx, although many of the major Japanese manufacturers have had dynamic-range enhancers in their lines at one time or another. The dynamic-range enhancer is designed to compensate for the compression deliberately introduced during recording, mixing, and mastering. Recording and cutting engineers use compression to compensate for limitations in the recording medium they work with. LP records and tapes have problems at both ends of the loudness range; soft signals are likely to be buried under hiss, and loud signals at certain critical frequencies can overload the record groove, tape, or playback system.

FM broadcasters have similar problems. They're caused mostly by the FCC-mandated high-frequency pre-emphasis, and by the 20 dB or so loss in signal strength inherent in today's stereo-broadcasting technology. Most broadcasters use some kind of compressor to provide a reasonably "loud" signal while preventing overmodulation of the transmitter.

And the wide dynamic range of the compact disc has aggravated the broadcaster's overmodulation problems and made compression even more necessary.

The dynamic-range enhancer reverses the compression process by making soft signals softer and loud signals louder. Since the enhancer has no way of knowing what the original dynamic range was, it is designed to make educated technical guesses under user control.

Earlier, I suggested that part of the confusion about processors probably derives from the fact that there is some overlap between their functions. In the case of the dynamic-range enhancer, making the soft signals softer helps the signal-to-noise ratio because hiss falls into the category of a soft (if unwanted) signal.

Next time we'll cover the most popular, and the most misunderstood signal-processing component—the equalizer. **R-E**

ELENCO PRODUCTS AT DISCOUNT PRICES!



20 MHz DUAL TRACE OSCILLOSCOPE
\$349 MO-1251

TWO
100 MHZ
SWITCHABLE
PROBES
INCLUDED



35 MHz DUAL TRACE OSCILLOSCOPE
\$498 MO-1252

Top quality scopes at a very reasonable price. Contains all the desirable features. Elenco's 2 year guarantee assures you of continuous service. Two 1x, 10x probes, diagrams and manual included. Write for specifications.



MULTI METER with CAPACITANCE and transistor tester

\$65 Model CM-1500

Reads Volts, Ohms, Current, Capacitors, Transistors & Diodes



TRUE RMS 4 1/2 DIGIT MULTIMETER

\$135 Model M-7000

.05% DC Accuracy
.1 % Resistance with Freq. Counter & Deluxe Case



AUTO RANGING MANUAL RANGING 3 1/2 DIGIT METER 28 FUNCTIONS FULLY PROTECTED

M-1180 .7% ACY \$36.95
M-1182 .25% ACY \$39.95
M-1181 .1% ACY \$42.95



GF-8016 Function Generator with Freq. Counter

\$219

• Sine, Square, Triangle, Pulse, Ramp, .2 to 2 MHz
• Frequency .1 thru 10 MHz

GF 8015 without Freq. Meter \$169

10 MHz OSCILLOSCOPE

\$190
S-3000

10 MHz DC or AC Triggered Sweep
Calibrated Vert & Hor
Reads Volts & Freq

BREADBOARD

Shown 9436

9430 1,100 pins \$15
9434 2,170 pins \$25
9436 2,860 pins \$35



Triple Power Supply XP-660

\$149.50

0-20V @ 1A
0-20V @ 1A
5V @ 5A

Fully Regulated, Short Circuit Protected with 2 Limit Cont. 3 Separate Supplies.

50 MHz LOGIC PROBE

\$23



20 nec with memory

LOGIC PULSER

\$25



2 us pulse @ 1A



3 Amp Power Supply XP-650

\$119.50

0-40V @ 1.5A
0-20V @ 3A

Fully regulated, short circuit protected current limit control



DIGITAL LCR METER

Model LC-1800
Measures: Inductors
Capacitors, Resistors

\$148

Inductors 1μH to 200 H
Capacitor .1Pf to 200μf
Resistor .01Ω to 20M Ω
Ranges 6 Ind, 7 cap, 7 res

C&S SALES, 8744 W. North Ter. Niles, IL 60648
800-292-7711 (312) 459-9040



15 DAY MONEY BACK GUARANTEE ASK FOR CATALOG

2 Year Limited Guarantee! Add 5% for Postage (\$10 max.), IL Res., 7% Tax

CIRCLE 109 ON FREE INFORMATION CARD

ANTIQUE RADIO

Portables

THIS TIME WE'LL TALK ABOUT BATTERY-powered (and three-way) portable radios. We'll discuss the origin and development of portables, as well as servicing hints. But first, let's take a look at a special radio/phono combination set.

The antique of the month

The unique Philco (Model 46-1207) shown in Fig. 1 was very popular right after WWII. The quality of the cabinet of a new set was ho-hum, but it probably went for less than \$40 new. The one pictured needed some work and cost me \$10.

That Philco was popular not because of an unusual radio chassis, but because of its front-loading 78 RPM record changer. In fact, the chassis was really standard, but records could be played loud enough to allow dancing in a large room. Maximum volume had to be considered when buying a small record player back then.

The superheterodyne chassis has a 455-kHz IF and five loctal tubes. The 50X6 rectifier and 50A5 output tube are getting scarce, but there are still some around. A 7C6, 7A5 and 7B7 round out the tube complement.

Besides its unique appearance,

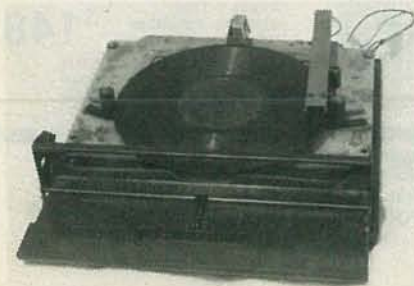

FIG. 1



FIG. 2

the Philco is a valuable collectible because of its novel method of loading records. Of course, only one record can be loaded at a time. Loading is accomplished by operating a bottom-hinged horizontal door in the front portion of the cabinet.

Operation is controlled by a series of levers and springs attached to the door. After opening the door, the spindle retracts beneath the turntable, and the arm and the stylus are raised to free the record, which can then be removed and replaced by another. When the door is closed, the spindle comes up through the record and the stylus is placed gently on the edge of the record. Various adjustments

allow you to "fine-tune" mechanical operation.

Portable background

The mention of a portable radio brings to mind a tiny receiver that you can carry in your pocket or hang from the mirror of your VW. Portables eventually evolved in that direction, but, actually, the portable receiver goes all the way back to the first production radio.

Of course you never carried one of these early receivers in your pocket; two hands was usually the minimum. In the early days of radio, the word *portable* was used quite loosely.

Over the years, various incidents in history have caused sur-



RICHARD, D. FITCH,
CONTRIBUTING EDITOR

ges in the popularity of the portable receiver. For example, a natural disaster such as an earthquake causes an upsurge in portable-radio sales so that those affected can maintain contact with the outside world.

Another example of how external events affect the radio industry was the boom in sales that happened during the early 1960's, when many people built fallout shelters. Plans were abundant in magazines and newspapers, and many homeowners were busy planning and building their own fallout shelters. And a portable radio was considered to be at least as important, if not more so, than many other types of equipment and supplies.

Probably there are still thousands and thousands of those tube-type portable radios from the 1930's, 1940's, and 1950's standing by in those abandoned fallout shelters, alongside the soda crackers and canned water. I only hope that someone remembered to remove the batteries.

Types of portables

During the 1930's, 1940's, and 1950's, a portable radio referred to a completely self-contained receiver with a carrying handle. You could strut down the street carrying the box by the handle. Music would emanate from the box to the amazement (and envy) of everyone. Owning a portable was an easy way to gain instant popularity, because wherever you went you were asked to bring your radio. Several Motorola portables from different eras are shown in Fig. 2.

By the 1950's, the word portable came to mean anything with a handle on top. But it really meant nothing, especially in the phrase *portable TV*. The so-called portable still required AC power, and, although it could be moved, doing so was not something one undertook lightly.

Also, the handles were notoriously weak, and after enough of the flimsy handles broke off (and TV's dropped to the floor!) the handles were eliminated. Then the consumer carried his "portable" TV from room to room in his arms, like a crate of oranges. Actually, many of those 1950's TV's (with

their metal cabinets) were deadly and shouldn't have been carried at all.

Backing up a little, by the mid-1920's manufacturers knew that radio would continue to be a big industry for years to come, because it promised to alleviate the boredom and loneliness of dreary days and long winter nights. The problem was that, in the summer, listeners drifted (pun intended?—*Editor*) away from their radios. Trips to the beach and vacation resorts didn't include a cumbersome radio. But the challenge was taken up by the industry.

By the late 1920's, what was known as the summer slump in radio sales was coming to an end. High-powered radio stations and better-designed portable receivers gave broadcast stations a year-round audience. The increasing popularity of automobile receivers also increased that audience. Although some groups suggested that the driver might be distracted while tuning (or listening to) an auto radio, their worries went unheeded. Also, the noise coming from an automobile, especially a touring car (like a four-door convertible) could be a nuisance. Of course, the auto radio did survive, and it still is a nuisance at times.

Radios were destined to go in places other than boxes and cars. In 1930, at a winter boat show in New York, many boats large and small featured custom-installed broadcast radio receivers. Some were modified home receivers. Being familiar with early radios, as well as boats and motors, I'd have to say that that was a bold step for the industry. Dampness, RFI from the engine's ignition system, as well as the pounding motorboats are subject to, all played havoc with these early receivers. I can still see 01A's rolling around the deck as a boat pounds across Sheepshead Bay.

It was usually suggested that the radio be placed as far from the engine as possible. That, of course, was a problem on a small boat with the engine amidships. It was also recommended that a separate battery be used to heat the tube filaments. In addition, magnetic, rather than dynamic, loud-

Capacitance, logic and more. For less.

Now, a fully-loaded DMM combines a capacitance meter, logic probe, and an hFE meter, all for the price of a DMM.

- TTL Logic Probe: 20 MHz
- Hi/lo/off indications
- Detects 25nS pulse width
- Capacitance: 5 ranges (2nF to 20μF)
- hFE (NPN or PNP): 1 range (1000)
- DMM: DCV-5 ranges (.2V to 1kV)
- ACV-5 ranges (.2V to 750V)
- DCA-4 ranges (200μA to 10A)
- ACA-3 ranges (20mA to 10A)
- Ohms-7 ranges (200 Ohms to 2000 Megohms)
- Continuity beeper
- Diode check
- Built-in bail
- Anti-skid pads

See one now at your local Beckman Industrial distributor.

DM25L... \$89⁹⁵*

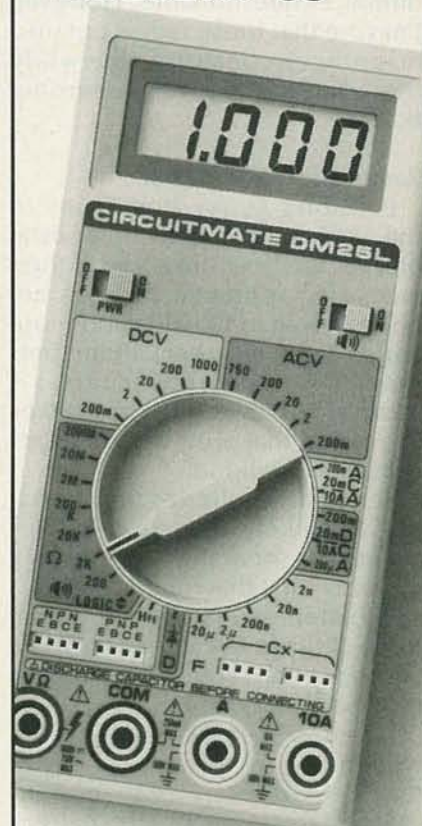

*Suggested list price (\$US) with battery, test leads and manual.

Beckman Industrial™

Beckman Industrial Corporation
A Subsidiary of Emerson Electric Company
630 Puente Street, Brea, CA 92621
(714) 671-4800

© Copyright 1985 Beckman Industrial Corporation

JANUARY 1987

CIRCLE 98 ON FREE INFORMATION CARD

75

Radio-Electronics mini-ADS

speakers were mostly used, to conserve power.

A modified home receiver used on a boat still needed an antenna and a ground for proper reception. One or two lengths of antenna wire stretched the length of the boat (above the mast spar, to avoid tripping over it) brought reasonable reception with one of the better radios.

Providing a ground was slight, more difficult. Trailing a 25-foot length of wire in the water behind the boat was one solution. Of course, a steel-hulled boat didn't have a grounding problem. But grounding to the metal strut that supports the prop shaft, or to the prop housing, resulted in a noise problem. Probably the best grounding solution was to affix a metal strip to the outer hull, below the water line, and attach the ground line from inside the hull.

How well those pioneer boat receivers worked under actual conditions is questionable. However, I'm sure that those radios put on a magnificent performance while the boat was on the showroom floor.

Restoration and repair

Portables suffer from many of the same problems as non-portables, as well as from a few of their own. First, portable cabinets are often designed to withstand more abuse (and weather) than their stay-at-home counterparts. A damp soapy rag is often all it takes to restore that type of box to acceptable condition.

Servicing a batteries-only portable will likely be fairly simple. However, servicing a three-way portable (one that runs on AC, DC, and batteries) may be somewhat more difficult, because of the extra components required to obtain three-way operation.

If you've never owned a tube-type three-way portable radio, you may be confused as to how to switch between AC and battery power. The switching is necessary because you can't operate from batteries while plugged into the AC line. Many radios have a similar switching arrangement. To operate the set from batteries, the line cord must be unplugged from the AC source and then plugged into



THE MODEL WTT-20 IS ONLY THE SIZE OF A DIME, yet transmits both sides of a telephone conversation to any FM radio with crystal clarity. Telephone line powered - never needs a battery! Up to ¼ mile range. Adjustable from 70-130 MHz. Complete kit **\$29.95 + \$1.50 S+H**. Free Shipping on 2 or more! COD add \$4. Call or send VISA, MC, MO. **DECO INDUSTRIES, Box 607, Bedford Hills, NY 10507. (914) 241-2827.**

CIRCLE 127 ON FREE INFORMATION CARD



APPLIANCE REPAIR HANDBOOKS—13 volumes by service experts; easy-to-understand diagrams, illustrations. For major appliances (air conditioners, refrigerators, washers, dryers, microwaves, etc.), elec. housewares, personal-care appliances. Basics of solid state, setting up shop, test instruments. **\$2.65 to \$5.90 each**. Free brochure. **APPLIANCE SERVICE, PO Box 789, Lombard, IL 60148. 1-(312) 932-9550.**

CIRCLE 84 ON FREE INFORMATION CARD



A CAREER START FOR THE 21ST CENTURY. Since 1905, National Technical Schools has helped people build successful careers. Enter the 21st Century through home study courses in Robotics, Computer Technology and Servicing, Microprocessors, Video Technology, Basic Electronics, Transportation Technology, Climate Control Technology or TV and Radio Servicing. For a FREE catalog, call 1-800-B-BETTER. Or write **NTS/INDEPENDENT TRAINING GROUP, 456 West M. L. King Jr. Blvd. L.A., CA 90037.**

CIRCLE 191 ON FREE INFORMATION CARD

CALL NOW AND RESERVE YOUR SPACE

- 6 × rate \$745.00 per each insertion.
- Reaches 239,312 readers.
- Fast reader service cycle.
- Short lead time for the placement of ads.
- We typeset and layout the ad at no additional charge.

Call **516-293-3000** to reserve space. Ask for Arline Fishman. Limited number of pages available. Mail materials to: mini-ADS, RADIO-ELECTRONICS, 500-B Bi-County Blvd., Farmingdale, NY 11735.



AC LINE DISTURBANCE MONITOR Detects, stores and displays worst case AC line voltage variation due to sags and surges. 1½ cycle and 3 cycle selectable time constants. Internal and external alarm activate if AC drops below 100 V or exceeds 130 V. 60 to 160 V range. One year warranty. **LDM-120, \$99.00 plus 4.00 Ship.** CA res 6.5% Check, money order or C.O.D. (add \$3.00). **TESTWARE, 4425 Canoga Ave., Woodland Hills, CA 91364, (818) 346-8370.**

CIRCLE 192 ON FREE INFORMATION CARD



CABLE TV CONVERTERS AND DE-SCRAMBLERS. Large selection of top quality merchandise. Low prices. Quantity discounts. We ship COD. Most orders are shipped within 24 hrs. Send **\$2.00** for catalog. **CABLETRONICS UNLIMITED, P.O. Box 266 Dept. R, S. Weymouth, MA 02190 (617) 843-5191**

CIRCLE 200 ON FREE INFORMATION CARD

Radio-Electronics mini-ADS

Cable Distributors

116 Main Street
Washington, Arkansas 71362
(501) 777-5850 or (501) 777-6564

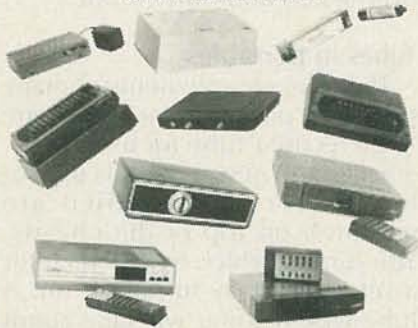

CABLE TELEVISION CONVERTER descrambler and microwave television antenna equipment accessories. Video catalog free. **CABLE DISTRIBUTORS**, 116 Main Road, Washington, AR 71362.

CIRCLE 204 ON FREE INFORMATION CARD

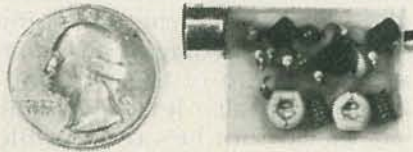

SIMPLY SNAP THE WAT-50 MINIATURE FM TRANSMITTER on top of a 9v battery and hear every sound in an entire house up to 1 mile away! Adjustable from 70-130 MHz. Use with any FM radio. Complete kit **\$29.95 + \$1.50 S+H**. Free shipping on 2 or more! COD add \$4. Call or send VISA, MC, MO. **DECO INDUSTRIES**, Box 607, Bedford Hills, NY 10507. (914) 232-3878.

CIRCLE 127 ON FREE INFORMATION CARD



FREE CATALOG OF HARD-TO-FIND TOOLS is packed with more than 2000 quality items. Your single source for precision tools used by electronic technicians, engineers, instrument mechanics, schools, laboratories and government agencies. Also contains Jensen's line of more than 40 tool kits. Send for your free copy today! **JENSEN TOOLS INC.**, 7815 46th St., Phoenix, AZ 85044. (602) 968-6231.

CIRCLE 115 ON FREE INFORMATION CARD

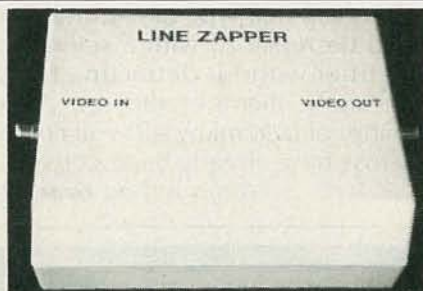

DESCRAMBLE THE NEW VIDEO TAPE COPY PROTECTION SCHEME. When you rent or buy a recent movie release, stop the vertical jumping and jittering in your TV picture with the **LINE ZAPPER**. This project detects and removes selected lines of video that have been modified and often interfere with normal television operation. Get your kit today only **\$69.95** plus **\$2.00** for S&H. Allow 6 weeks for delivery. **ELEPHANT ELECTRONICS**, Box 41865-L, Phoenix, AZ 85080. (602) 581-1973. MC and Visa accepted.

CIRCLE 120 ON FREE INFORMATION CARD

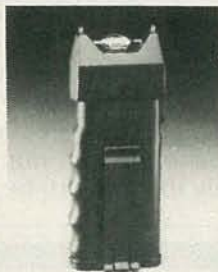

SAFE-LEGAL-EFFECTIVE STUN GUN VIPER II. Instantly immobilizes an attacker up to 15 minutes. Penetrates through leather and thick clothing. Discharges 50,000v from a single 9v NiCad battery. Used by police around the country. 1 Year Guarantee. 1 Viper II **\$39.95**. With NiCad battery and charger **\$49.95**. Free belt clip with every Viper II. Catalog Free. **UNITED IMPORTS & MFG.**, 6846 PACIFIC ST. RE1, OMAHA, NE 68106, (402) 554-0383, TLX: 5106016153, MC, VISA, C.O.D.

CIRCLE 203 ON FREE INFORMATION CARD



NEW JERROLD CS 68 CHANNEL CABLE TV CONVERTER with volume control & descrambler loop (Port). Programmable clock turns TV on/off & changes channel. Audio mute kills commercials. Programmable channel scan. Instant channel recall. Automatic fine tuning with manual override. Video & audio outputs. Friendly to all descramblers. Specify output. 1 year warranty. **\$139. \$110 ea./case lot of 10**. Free delivery. Dealers wanted. (514) 739-9328. **CROSLY ELECTRONICS**, Box 840, Champlain, N.Y. 12919.

CIRCLE 202 ON FREE INFORMATION CARD



60 dB SIGNAL ELIMINATOR—for removal of undesirable TV/FM/VHF signals. Can be tuned precisely to ANY signal within these ranges: *Model 26 - Ch's. 2-6 plus FM (54-108 Mhz) *Model 1422 - Ch's. 14(A) - 22(1) (120-174Mhz) *Model 713 - Ch's. 7-13 (174-216 Mhz). Highly selective notch/adjustable strength. Singles **\$30**. Quantity discounts to 60%. **STAR CIRCUITS** - P.O. Box 8332 - Pembroke Pines, FL. 33084

CIRCLE 94 ON FREE INFORMATION CARD

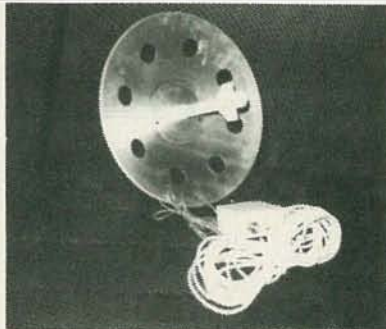

MICROWAVE ANTENNAS \$69.95. Now including shipping and Lifetime warranty. We Repair all types of Downconverters. Cable Converters and equipment available! Jerrold 400 wireless Converter **\$72.95** plus shipping. Coax cable, T.V. parts, accessories, connectors, T.V. amplifiers. Write for free catalog or call for prices. **BLUE STAR IND.**, Dept. 105-RE 1-87, 4712 Ave. N, Brooklyn, N.Y. 11234 (718) 338-8318 Ext. 105.

CIRCLE 85 ON FREE INFORMATION CARD



ZENITH SSAVI, SALE \$169. UHF gated pulse **\$199**. Original reconditioned equipment for UHF channels 27,48,51, etc. Quantity discounts. Satellite Systems; surplus N-12, SB-3, Hamlin 1200. Converters, amplifiers, accessories. Catalog containing coupon **\$1**. SSAVI modification/troubleshooting handbook **\$6.50** ppd. **AIS SATELLITE, INC.**, P.O. Box 1226-RE, Dublin, PA 18917. (215) 249-9411.

CIRCLE 81 ON FREE INFORMATION CARD

the chassis. Doing so disconnects the AC from, and connects the batteries to the proper power-supply components.

The receptacle for the plug on the chassis doesn't look anything like a normal wall receptacle. In fact, if it's not marked, and you're not familiar with that type of connection, you may have trouble finding where to insert the plug. Often, the receptacle is just a slot or two in the metal chassis. If there is only one slot, the other prong is meant to slide down the rear of the chassis.

Servicing

The first thing a serviceman would do with a portable would be to plug it in and turn it on. If the set is dead, he would assume that one of the fragile tube filaments was open. He would then check the tubes and find the one with an open filament. However, you must be very careful in checking the delicate tubes used in portables.

For example, it's probably not a good idea just to replace a known-bad tube. You might be lucky, and

the set might work. But a condenser surge could destroy even more tubes. So, before replacing any tubes, it's best to remove them all, discharge all condensers, and then re-insert the tubes. In fact, a smart radioman removes all tubes and checks them before doing anything else. Doing so gives him a clear picture of the set's condition. That also lets him know whether or not he's responsible for burning out any tubes.

If a three-way set works only one way (batteries or AC or DC), isolating the problem can be simple, if you use your head. For example, you might suspect simply that the batteries of a set that worked on AC but not on batteries were weak. However, a set might be operating at slightly higher voltages when operating on AC. The oscillator section of the converter might oscillate with the higher voltage, but not when powered by batteries. A new oscillator tube might solve the problem.

On the other hand, if a set operates on batteries, but not on AC, most likely there is a defect in the

power supply. Any reduction in AC operating voltages can cause the same problems as just mentioned for battery operation. The nose of an experienced radioman can tell whether the selenium rectifier has overheated and burned out.

Tubes in portables

The tube complements of many three-way portables include a type 117Z6 rectifier tube for use on AC. Smaller and newer models use selenium rectifiers, which are mounted on top of the chassis. You can tell which type of rectifier a set has just by turning it on. A tube-type rectifier will take about a half a minute to warm up, but a selenium rectifier will operate as soon as the set is turned on.

Like the 117Z6 rectifier, the 117Z3, 35Z5, etc., are still available if replacement is necessary. However, that type of rectifier can also be replaced with a selenium rectifier without detracting from the authenticity of the set. As a matter of fact, many sets you come across have already been converted

continued on page 81

BEST PRICES ON TEST EQUIPMENT!

INTERNATIONAL DATA SCIENCES, INC.



"The Blue Box" EIA Interface Monitor & Breakout Panel Model 60
List \$159.00 SALE \$137.46



Model No.	Description	List	SALE
1590A	100MHz quad input oscilloscope	\$1886	\$1584
2520	20MHz 2-channel oscilloscope	\$1895	\$1705
1420	15MHz portable oscilloscope w/ digital storage	\$825	\$693
1042	Telephone line analyzer	\$20	\$19
1045	Telephone product tester	\$415	\$350

OK Industries Inc.

New Test Equipment

Model No.	Description	List	SALE
206	Sweep/Function generator	\$895	\$805
512	Handheld frequency counter; 20Hz-200MHz	\$145	\$130
1010	10MHz miniscope	\$385	\$349
202	.02Hz to 200KHz function generator	\$239	\$219
510	200MHz multi-function counter	\$365	\$328
601	3 1/2 digit, 1% accuracy DMM	\$215	\$193
513	Prescaler; 40-600MHz	\$85	\$76
514	Prescaler; 100-1000MHz	\$120	\$107

FLUKE

3 1/2 Digit Multimeters with analog bar graph



Model No.	Description	List	SALE
73	7% Accuracy	\$79	\$74
75	5% Accuracy	\$99	\$89
77	3% Accuracy	\$139	\$124

FLUKE

Model No.	Description	List	SALE
51	Single input thermometer	\$119	\$106
52	Dual input K/J thermometer	\$189	\$168
21	Analog/Digital Multimeter	\$99	\$89
23	Analog/Digital Multimeter	\$145	\$134

While Supplies Last

Weller \$77.50

WTCPR Controlled Output Soldering Station



Weller

Service Master Roll Kit

List \$95.71 SALE \$76.99
Includes 23 tools in plastic-coated canvas case: 6" long nose plier, 5" diagonal plier, 6" adjustable wrench, regular and stubby handles, 9 regular nutdrivers, 3 stubby nutdrivers, nos. 1 & 2 Phillips screwdrivers, 3/16" & 1/4" slotted screwdrivers, reamers and 7" extension. 99SM

Weller

Universal Soldering Kit

List \$28.22 SALE \$22.48
Includes dual heat soldering gun with 3 soldering tips, wrench, flux brush, soldering aid tool & solder in plastic carrying case. 8200PK

Weller

Professional Soldering Kit

List \$38.29 SALE \$30.50
Includes soldering gun with pre-tinned heavy copper tip, 2 spare tips, wrench, flux brush, soldering aid tool & solder in plastic carrying case. D550PK

TOLL-FREE

800-638-6405

W.S. JENKS & Son



1933 Montana Ave. NE
Washington DC 20002
(202) 529-6020

Telex: 89-2667
FAX: (202) 832-3411

COMPUTER DIGEST

VOL. 4 NO. 1 JAN. 1987

A NEW KIND OF MAGAZINE FOR ELECTRONICS PROFESSIONALS

TVRO

You Can Use Your Computer To Aim The Dish



5 VOLT RS233

Something Else You Can't Live Without!

ALL ABOUT INTERFACING PART II

Completing And Testing Your
Interconnections

A
GERNSBACK
PUBLICATION

CONTENTS

Vol. 4 No. 1

January 1987

6 TVRO Antenna Pointer

Finally, a quick and easy system that can be used to advantage whether you erect lots of dishes each week, or just one for yourself.

Edmund T. Tyson

10 5-Volt RS-232

There's a new chip available that's making a lot of circuitry a thing of the past. It's called the MAX232 and here's how to use it.

Rodney A. Kreuter

12 TV Channel Frequency Program

Enter this program, do it just once, and you'll never have to look those numbers up again. **Michale Kiley, WA9ZPM**

13 All about Interfacing, Part II

We began this article last month and present the conclusion here.

This one is a "Clip-and-Save!" **Jeffrey K. Holtzman**

3 Editorial

4 Letters

4 Computer Products

5 Software Review

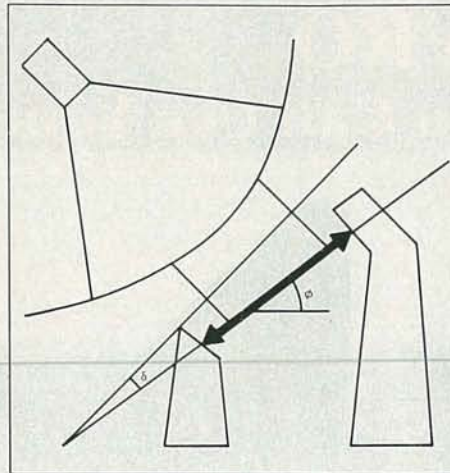

See Page 6

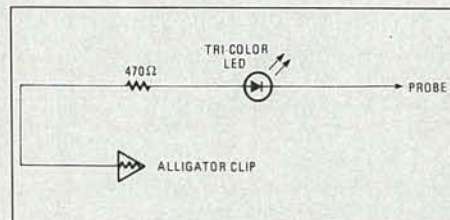

See Page 13

ON THE COVER

Author Ed Tyson has been busy putting in TVRO installations. The one on this month's front cover is from the McDonald Observatory, in Texas. The complete article begins on page 6 of this issue. In error, the article was run last year in the October Issue, with the wrong program.

COMING NEXT MONTH

Every once in awhile, an editor can sit back and smile with some small measure of pride over a well-done job. And before I break my own arm patting myself on the back, here's what's in store for you: A build-it-yourself protocol converter, a TV channel frequency program, a story on undocumented op codes that just might make your next chip a lot more useful, and an up-to-the-minute article on concurrency that you *have* to read! Don't miss our next great issue!



EDITORIAL

The beginning of the end...

■...Of copy protection is at hand. Ashton-Tate, who manufacture such important software programs as dBase database managers, recently announced that copy protection would be removed from all its software. We applaud Ashton-Tate for this action.

Manufacturers assumed that the computer operator was going to make copies of any software he purchased, distributing it to all his friends or (worse yet) selling unlimited copies for less than he paid for it. Naturally, this sort of piracy would cost the software manufacturer, for it would reduce the potential for sales.

So copy protection would be installed on the software. This made it extremely difficult for a legitimate user to make a backup copy, or to store on his hard disk. As for the real pirate, it didn't stop him, it was just another nuisance he had to work around. And the truth of the matter is that copy protection didn't do any more than create problems without solving any.

Today, we see advertisements that read "Not copy protected." And we're starting to see more and more of those advertisements as well.

Certainly, the manufacturers are entitled to a profit from their investment in a software program, but we already have such protection in place in the form of our copyright laws. These can cover a new software just as easily as they would cover a new book that's been published. And copy protection is to software, what locking closed the pages of a book would be. While this writer is certainly not a lawyer, it seems that the plagiarism and copyright laws that are now in place, should be sufficient protection if the need to exercise them ever arises.

Ashton-Tate, long a leader in our industry, has taken a major forward step. We can only hope that others will follow. ◀▶

Byron G. Wels

ComputerDigest is published monthly as an insert in Radio-Electronics magazine by Gernsback Publications, Inc., 500-B Bi-County Blvd., Farmingdale, N.Y. 11735. Second-Class Postage Paid at New York, N.Y. and additional mailing offices. Copyright © 1986 Gernsback Publications, Inc. All rights reserved. Printed in U.S.A.

A stamped self-addressed envelope must accompany all submitted manuscripts and/or artwork or photographs if their return is desired should they be rejected. We disclaim any responsibility for the loss or damage of manuscripts and/or artwork or photographs while in our possession or otherwise.

COMPUTER DIGEST

M. Harvey Gernsback,
editor-in-chief, emeritus

Larry Steckler,
EHF, CET: publisher & editor in chief

Art Kleiman,
editorial director

Byron G. Wels,
editor

Brian C. Fenton,
managing editor

Carl Laron,
associate editor

Robert A. Young,
assistant editor

Jeff Holtzman
technical editor

Teri Scaduto Wilson
editorial assistant

Ruby M. Yee,
production director

Karen Tucker,
production advertising

Robert A. W. Lowndes,
production associate

Geoffrey S. Weil,
production assistant

Andre Duzant,
technical illustrator

Jacqueline P. Cheeseboro
circulation director

Arline R. Fishman,
advertising director

Computer Digest
Gernsback Publications, Inc.
Executive offices
500-B Bi-County Blvd.,
Farmingdale, NY 11735
516-293-3000

President: Larry Steckler
Vice President: Cathy Steckler

ADVERTISING SALES 516-293-3000

Larry Steckler
Publisher

NATIONAL SALES

Joe Shere
1507 Bonnie Doone Terrace
Corona Del Mar, CA 92625
714-760-8967

LETTERS

Flight Simulators

I've been playing around with flight simulators on my computer. Can those things actually teach me to fly?—R.D., Tacoma, WA.

They can sure save you a lot of expensive dual-time when you're learning navigation, but as an old-timer once said, "If you want to learn about flying, watch the birds. But if you want to learn HOW to fly, get into an airplane!"

Bridge for Sale!

My new computer has been nothing but trouble since I bought it, and the salesman explained that it just takes time to break-in. Exactly how long should this break-in period be?—L.B., Oshkosh, WI.

At least until the 3,000 mile check. Now let me tell you about this slightly-used bridge in

Brooklyn that I can let you have real cheap... But seriously, get to a technician if you're having problems.

Who Goofed?

Somebody goofed up in the October Issue last year. You announced a TVRO Antenna Pointer, and the program talked about anything but that. What hopen?—S.T., Kansas City, MO.

Mea culpa, mea culpa, mea maxima culpa. Make sure you check the table of contents for this issue. I'm pretty sure we got it right this time.

To Err Is Human

What happens if a mistake is made in the magazine and I build something and it doesn't work? Am I just "stuck?" R.P., Jericho, NY.
Not at all! Actually, if you had

any idea of the complexity involved in getting an author's "rough" diagrams to the finished, printed page, you'd be surprised that even more mistakes are not made. If you do have a problem, by all means write in and let us help you solve it.

Hi, Brilliant!

I happened on your magazine at my dentist's office and started flipping the pages. To my surprise, I was able to understand much of it, even though I have no real background in electronics, much less computers. I guess I'm just brilliant. Talking to my dentist later, I found that he has a personal computer and well—to make a long story short—my subscription is enclosed. T.P., Long Beach, CA.

Welcome to the 20th Century! Delighted to have you with us.

COMPUTER PRODUCTS

For more details use the free information card inside the back cover

GAME PROGRAMS, *Gerry and the Germ* and *Microcosm*, are the latest titles released in Firebird Licensees' Super Silver Disk series for Commodore 64/128 computers.



CIRCLE 18 ON FREE INFORMATION CARD

Gerry the Germ, is a lighthearted romp through the human body as Gerry sets out to prove his worth as a virulent virus. *Microcosm* puts the player aboard a crippled interstellar freightliner as the sole defender of a priceless agricultural cargo against a devouring horde of mutant insects.

Both games feature musical and sound effects, graphics and animation, challenging play action and either joystick or keyboard control.

The suggested price is under \$20.00—**Firebird**, P.O.Box 49, Ramsey, NJ 07446.

MEMORY UPGRADES, The *XTend Kits* are designed for use with the IBM XT and portable computers. The *XTend* upgrade involves removing the XT's system board, replacing two rows of 64K RAMS with 256K RAMS, removing a decoder PROM, and installing a specially programmed replacement, and inserting a 16-pin IC into an empty socket on the board.

One model of the *XTend* upgrade kit allows the user to upgrade an XT for \$10.00 (not including RAM chips). The *XTend Multi-Pak*, priced at \$99.00, includes a decoder and logic chips to upgrade ten computers. It includes 10

diskettes and 10 software manuals.

The *XTend Plus* kit, which also sells for \$99.00, provides everything the



CIRCLE 19 ON FREE INFORMATION CARD

user needs to perform an upgrade on a single XT, including RAM chips. The basic *XTend* kit includes RAMtest, RAMdisk, and Printer Spooler software on diskette, as well as a handy IC puller. Also included are hardware installation and software operation manuals.—**VERICOMP**, 8825 Aero Drive (Suite 210), San Diego, CA 92123.

SOFTWARE REVIEW

Webster's new On-Line Thesaurus...

**Webster's
NewWorld
On-Line
Thesaurus**

Software for the
IBM PC,
PC XT,
PC AT, PCjr

Works behind the scenes to
make you a better writer.

- Access more than 100,000 synonyms as you write
- Choose a synonym, press a key, and your text is instantly improved
- Compatible with most word processors
- Based on Webster's New World Thesaurus

**Webster's
NewWorld
Thesaurus**

SEE LISTING
ENTIRE

Simon & Schuster

■ This offering from Simon and Schuster (\$69.95, Simon and Schuster, Rockefeller Center, 1230 Avenue of the Americas, New York, NY 10020) is the latest entry in the writer's-aid market and a good way to supercharge your favorite word processor. It was written by Korenthal Associates of New York, and is based on the Webster's New World Thesaurus and has over 120,000 cross-referenced synonyms to help find exactly the word or phrase you want. There are many thesaurus' on the market, but this one can't be beat on a feature-for-feature basis.

When you run the installation program, you'll see that Webster's already knows about 26 of the popular word processors. If yours is among them, all you've got to do is press a key. If yours is not on the list, you tell Webster's how yours works. All it needs to know is the key you press for insert, delete, etc. If you know your word processor, you can get through the installation in under a minute. And changes can be made as easily, even from inside your word processor.

Webster's is made up of two files. First is the control program in high memory until you reboot. It watches the keyboard buffer, and when it sees the key you've set as the trigger, it puts a window on the screen and hunts the phrase or word at the cursor, in the dictionary, which is the second file. Webster's is smart. If it can't find a match, it will show a list of words spelled like the word you are seeking. If your word is not there, you can browse through the entire dictionary, try alternate spellings, see synonyms for any word on the list, or even synonyms for the synonyms.

It's easy to use. Since it weighs in at 360K, it should really be run off a hard disk. You can use it in a two-drive system, but one will have to be dedicated to the dictionary. If you have sufficient memory, you can stuff it in ramdisk but this might leave you short on space for your word processor. It will work in whatever configuration you create, and whatever limitations exist will be set by your hardware, not Webster's software.

Once you're up-and-running, you only have to remember the key that activates the Thesaurus. The F1 key offers a complete help screen, but after a few times, you won't need that anymore. The program looks up the word at the cursor, you browse through the suggested synonyms using the cursor keys and pressing the F10 key makes the substitution.

It first looks for the entire word, and if there's no match, it seeks the root of the word. If that fails, it shows you a list of words with similar spellings.

Each control program can contain parameters to make it work with three different word processors and you can switch between them. By installing and saving a second time under a different name, you can put several versions on a single disk. The written manual walks you through it step-by-step. And the manual has some interesting appendices on word usage in general.

Using Webster's is habit forming. Once you're accustomed to it, there's no way you'll use your word processor without it. And when you realize that it does about twice as much as its competitors for less than half the price, you'll realize that it's more than just a bargain—it's an outright steal! ◀▶

CIRCLE 17 ON FREE INFORMATION CARD

TVRO ANTENNA POINTER PROGRAM

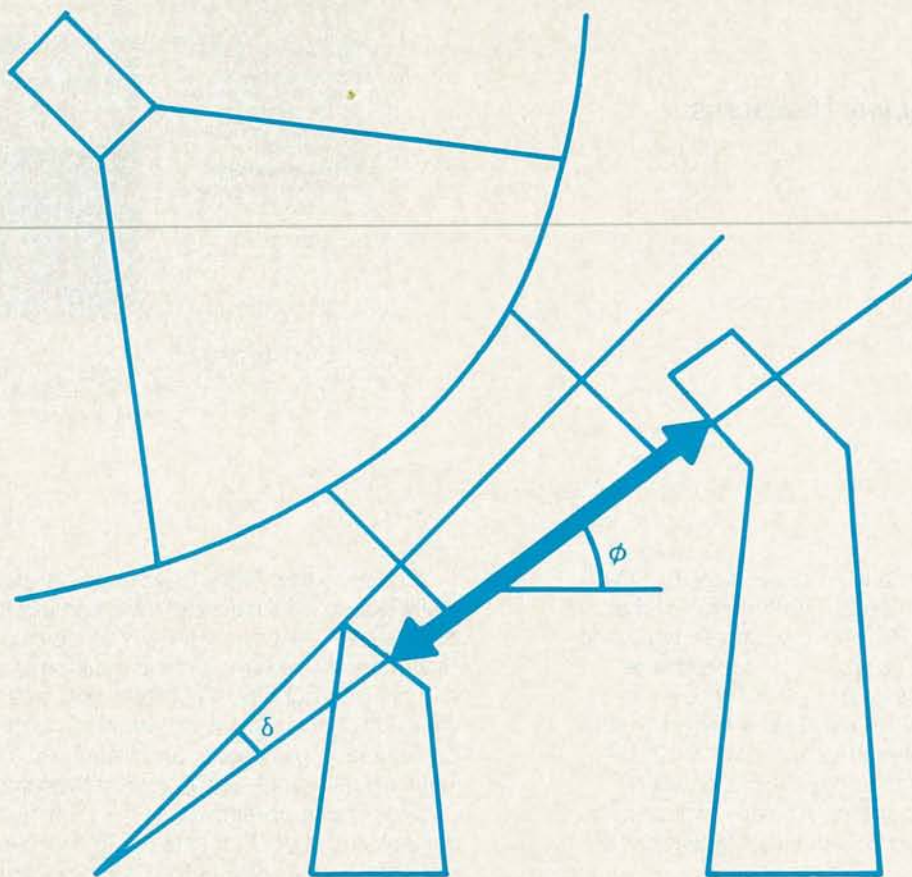

Your computer can accurately point your TVRO antenna.

Edmund T. Tyson

■ Most articles give pointing angles in azimuth/elevation coordinates. But the working coordinate system for most antennas is identical with the astronomical hour angle/declination coordinate system. In this system, the hour angle axis is parallel with the spin axis of the Earth and the declination axis is orthogonal to the hour angle axis. So the antenna points to any satellite in the Clarke belt by motion about a single axis. The Clarke belt is a band in space above the equator, some 22,240 miles up. Satellites in this belt make one revolution about the Earth in a day, so they appear fixed in one spot in the sky.

About the program

This program calculates angles for pointing TVRO antennas at synchronous satellites. It is written in BASIC for use on many computers. We tested it in midsummer by computing telescope settings to observe satellites broadcasting TV signals. A telescope observatory in the southwest confirmed the angles by seeking and finding the satellites. A dial was designed that permits pointing an antenna at a chosen satellite without searching.

The program is useful only for calculating synchronous satellite positions and is based on these assumptions: Inclination of the satellite orbit to the

```

100 COMPUTE POINTING ANGLES
105 FOR TVRO ANTENNA
110
120 DEFSNG A-H, 0-Z
130 DEFINIT I-N
140 CLS
150 PI=3.141593#
160 D2R=PI/180
170 RE=6378.165
180
200 **** OBSERVER COORD ****
210 PRINT "OBSERVER N LAT/W LONG";
215 INPUT ,FLAT, FLONG
220 FLONG=-FLONG
221 WLONG=-FLONG
225 LPRINT "TVRO AT N LAT=";
226 LPRINT ,FLAT, " W LONG=";WLONG
227 LPRINT
230 X=I
240 Y=0
250 Z=0
260 ROTATE ABOUT "Y" BY LAT
270 AX=FLAT
280 IAX=2
290 GOSUB 1000
300 ROTATE ABOUT "Z" BY -LONG
310 AX=FLONG
320 IAX=3
330 GOSUB 1000
340 XO=-X
350 YO=-Y
360 ZO=-Z
390 LPRINT " SAT LONG AZIM";
391 LPRINT " ELEV HR AX";

392 LPRINT " DEC AX RANGE KM"
399 *****
400 **** SAT COORD ****
410 CLS
415 LPRINT
420 INPUT " SAT LONG ", SLONG
421 SLAT=0
425 SLONG=-SLONG
426 GLO=-SLONG
428 RADIUS VECTOR OF
429 SYNC SAT = 6.611 ERU
430 X=6.611
431 Y=0
432 Z=0
435 ROTATE RV ABOUT "Y" BY SLAT
436 AX=SLAT
437 IAX=2
438 GOSUB 1000
440 ROTATE RV ABOUT "Z" BY -SLONG
441 AX=SLONG
442 IAX=3
443 GOSUB 1000
450 TRANSLATE EQ COORD
451 TO OBSERVER
455 XS=X+XO
456 YS=Y+YO
457 ZS=Z+ZO
460 COMPUTE HOUR ANGLE
461 AND DECLINATION
470 GOSUB 2000
471 DAH=(AX/D2R)+FLONG
472 REQ=SQR(XS*XS+YS*YS)
473 DAD=ATN(ZS/REQ)/D2R
474 RS=SQR(REQ*REQ+ZS*ZS)*RE

500 **** ROTATE TO TOPOS ****
501
510 X=XS
511 Y=YS
512 Z=ZS
515 ROTATE TRANS COORD
516 ABOUT "Z" BY (LONG-90)
520 AX=-FLONG-90
521 IAX=3
522 GOSUB 1000
530 ROTATE TRANS COORD
531 ABOUT "X" BY (LAT-90)
535 AX=FLAT-90
536 IAX=1
537 GOSUB 1000
540 XS=-Y
541 YS=X
542 ZS=Z
543 RT=SQR(XS*XS+YS*YS)
545 GOSUB 2000
550 AZ=AX/D2R
551 EL=ATN(ZS/RT)/D2R
LPRINT USING "*****";GLO;
LPRINT USING "*****";AZ;
LPRINT USING "*****";EL;
LPRINT USING "*****";DAH;
LPRINT USING "*****";DAD;
LPRINT USING "*****";RS
580 GOTO 400
999 *****
1000 COORD ROTATION ROUTINES
1010
1020 AXR=AX*D2R
1030 SINX=SIN(AXR)
1040 COSX=COS(AXR)
1050 XT=X
1060 YT=Y
1070 ZT=Z
1080 ON IAX GOSUB 1100,1200,1300
1090 RETURN
1100 ****X ROT****
1110 X= XT
1120 Y= YT*COSX+ZT*SINX
1130 Z=-YT*SINX+ZT*COSX
1140 RETURN
1200 ****Y ROT****
1210 X= XT*COSX-ZT*SINX
1220 Y= YT
1230 Z= XT*SINX+ZT*COSX
1240 RETURN
1300 ****Z ROT****
1310 X= XT*COSX+YT*SINX
1320 Y=-XT*SINX+ZT*COSX
1330 Z= ZT
1340 RETURN
2000
2005 QATAN
2010 ARC TAN IN PROPER QUADRANT
2020 IF XS<0 GOTO 2060
2030 IF YS=0 THEN AX=0: RETURN
2040 IF YS>0 THEN AX=PI/2: RETURN
2050 IF YS<0 THEN AX=1.5*PI: RETURN
2060 AX=ATN(YS/XS)
2070 IF XS<0 THEN AX=AX+PI: RETURN
2080 IF YS<0 THEN AX=2*PI+AX
2090 RETURN

```

equator is small, eccentricity of the orbit is small, and the semi-major axis of the orbit is 6.611 Earth radii.

You need north latitude and west longitude of the antenna and west longitude of the satellite. South latitude and east longitude values must be entered as negatives. The program can be used for any geographical location of the observer and satellite longitude. Negative elevation angles show the satellite below the horizon for that location.

When executed, the program prompts for the geodetic position of the antenna and this is printed to label that data. Antenna position is then converted to geocentric rectangular coordinates and saved. Additional prompts request west longitude of each new satellite. These positions are converted to geocentric rectangular coordinates, antenna coordinates are subtracted and the vector is solved for hour angle and declination.

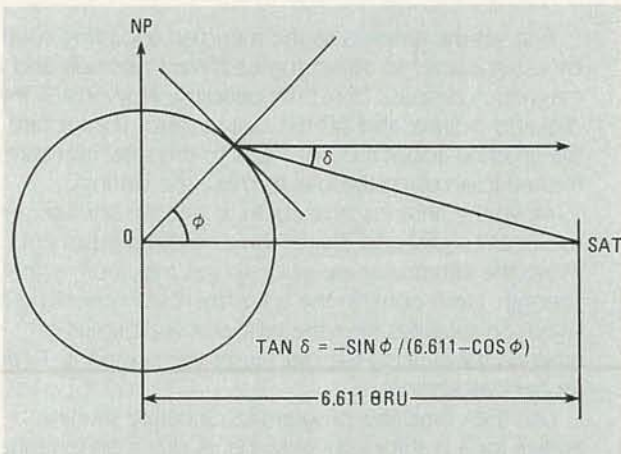

FIG. 1—DECLINATION OR OFFSET ANGLE is shown above. This is a sketch of Earth and satellite seen from the equatorial plane. The relation is described by the equation.

The hour angle

Hour angle is measured about the polar axis of the antenna mount. It's zero when the satellite is on the meridian, negative when the satellite is east of the observer, positive when it is west. Declination is the angle created by the observer's displacement from the equator. It is included in the mount setting by the *offset*

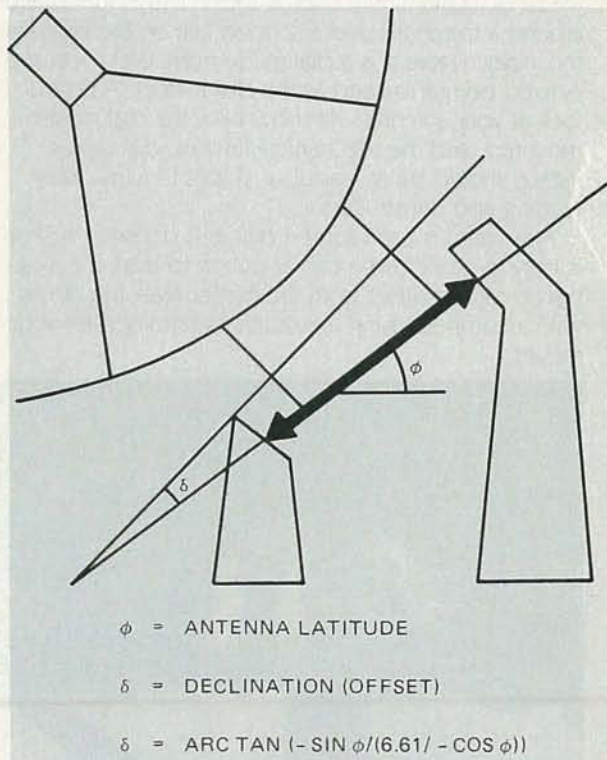

FIG. 2—HOW LATITUDE and declination angles are included in the antenna mount. The difference vector is rotated to the observer's position and solved for azimuth, elevation and slant range.

adjustment made during mount and dish assembly. Figure 1 shows the declination or offset angle. This is a sketch of Earth and satellite seen from the equatorial plane. Distance from satellite to Earth's center is 6.611 Earth radius units. An increase in latitude causes a related increase in declination. The equation describes the relation. Once calculated, a fixed angle for declination can be used as the change in declination from a meridian to an extreme east or west position is small compared to antenna beamwidth at C-band. Figure 2 shows how latitude and declination angles are included in the antenna mount.

The difference vector is then rotated to the observer's position and solved for azimuth, elevation and slant range. Azimuth is in degrees from north around through east as in the graduations of a compass. Elevation is in degrees above the horizon with zero degrees at the horizon and 90 degrees directly overhead. Slant range is the distance from antenna to satellite.

The printed output lists observer's position, satellite longitude, azimuth, elevation, hour angle, declination angle, and slant range in kilometers. Almost all TVRO antenna mounts use the hour angle/declination mode of motion. This is the best mount since it lets the antenna be aimed at any satellite by moving it on a single axis. This also allows constructing a simple dial that lets you point at any interesting satellite.

The dial

Figures 3 and 4 are typical dials. Figure 3 is a dial made of an aluminum cookie sheet. The mount rotates around a fixed dial and a scribed line on the frame is the index. Figure 4 is a dial made from .040 sheet stock. A fixed pointer is used as the dial rotates. A careful look at your antenna will show how the dial must be mounted, and the mechanical limit on dial radius. Radius should be at least four inches to allow easy reading and construction.

Aluminum is used for the dial as it does not rust and is easy to work. Use a center punch to mark the axis which can be offset from the center. Mark the radius with a compass using the radius determined for your mount.



FIG. 3—AN ALUMINUM COOKIE SHEET is used as a dial. The antenna mount rotates about a fixed dial with a scribed line on the frame as an index.

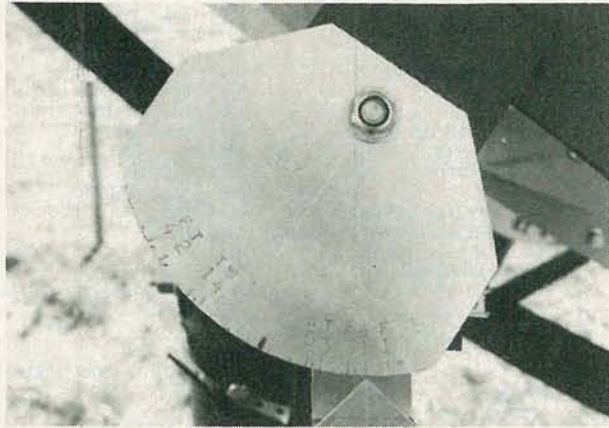

FIG. 4—DIAL FORMED FROM ALUMINUM STOCK. A fixed pointer is used since the dial rotates. Look at your own antenna to select the best form.

With a straightedge, divide the arc in halves to represent meridian or zero point and scribe a line through the punch mark and arc. A protractor is used to mark five degree angular increments of satellite positions as calculated by the computer program. Make sure you make the marks on the correct half of the dial. Satellites to the east of the antenna are prefixed with a negative (-) sign. The correct half changes depending on whether the dial rotates or is stationary.

Angular divisions of five degrees are adequate and can be marked by a double punch mark. Individual satellites are identified by scribing a mark at calculated angles along with an alpha-numeric label such as F4, W4, G1, etc. Antennas separated by a few miles need different dials as a one-degree shift in longitude results in at least a one-degree change on the dial.

A dial is a useful tool for technicians installing many antennas. The time to align can be reduced and precision improved. A dial calculated for the area where installations are done and marked with the east, west and meridian satellites will speed the process of alignment with the Clarke belt and setting remote positioning actuators and indicator systems.

Dial alignment procedure

First set the antenna to the meridian (pointing south) by using a level to adjust the east/west position and a magnetic compass to set the heading. Now install the dial and pointer and set the dial to zero. Then rotate the antenna about the polar axis to the satellite nearest the meridian using the dial to make the setting.

Move the antenna in azimuth to get the satellite with maximum signal and clamp the azimuth adjustment. Move the antenna in elevation to get maximum signal strength. Now confirm the adjustments by checking the signal on satellites near the east and west limits of antenna travel using the dial to set the positions. Finally, recheck all settings.

Use the computer program to calculate satellite angles for a dial for your antenna. A dial is an essential accessory for manually positioned antennas. It will eliminate guesswork when changing from one satellite to another. ◀(D)▶

Electronics Paperback Books

GREAT PAPERBACKS AT SPECIAL PRICES



BP173—COMPUTER MUSIC PROJECTS \$6.95. Shows how to use your home computer to produce electronic music. Many circuits. Mostly jargon-free.



BP170—AN INTRODUCTION TO COMPUTER PERIPHERALS \$5.95. Describes and explains how to use a variety of different computer equipment in as non-technical a way as possible.



37051—CUSTOMIZED MICROPROCESSOR PROJECTS \$14.95. Building instructions, detailed schematics and application programs for intriguing and useful dedicated CPU projects.



BP141—LINEAR IC EQUIVALENTS AND PIN CONNECTIONS \$12.50. 247 pages, 7 x 10 in. shows equivs & pin connections for popular user oriented IC's.



BP140—DIGITAL IC EQUIVALENTS AND PIN CONNECTIONS \$12.50. 312 pages, 7 x 10 in. shows equivs & pin connections for popular user oriented IC's.



BP187—REFERENCE GUIDE TO AMSTRAD WORD PROCESSING \$14.95. Everything you need to know about using these machines.



BP146—THE PRE-BASIC BOOK \$6.95. A book on the BASIC programming for those who have not yet bought a computer as well as those who have trouble learning how to program.



BP108—INTERNATIONAL DIODE EQUIVALENTS GUIDE \$5.75. Full interchangeability data and characteristics for diodes, including Zeners, LED's, Diacs, Triacs and more.



BP135—SECRETS OF THE COMMODORE 64 \$5.00. Masses of useful info and programming tips not found in any user's manual.



BP143—INTRO TO PROGRAMMING THE ATARI 800/800 XL \$5.00. Perfect complement to the Atari user's manual. Even shows how to use animated graphics.



BP148—COMPUTER TECHNOLOGY EXPLAINED \$5.00. Explanations for computer terms often encountered. A dictionary for computer lingo.



BP131—MICRO INTERFACING CIRCUITS—BOOK 2 \$5.75. Interfacing sound and speech generators, temperature and optical sensors, motor controllers, and more.



BP105—ANTENNA PROJECTS \$5.00. Practical radio antenna designs that deliver good performance and are relatively simple and inexpensive to build.



WHITES—WHITE'S RADIO LOG \$4.95. An up-to-date directory of AM, FM and TV stations, including a section on worldwide shortwave stations.



CONFID—CONFIDENTIAL FREQUENCY LIST, 6th edition \$15.95. Latest info on unusual and exotic shortwave broadcast stations.



BP134—EASY ADD-ON PROJECTS FOR COMMODORE 64, VIC-20, BBC MICRO & ACORN ELECTRON \$5.95. Picture digitizer, light pen, model controller and more.

Quality Paperbacks



BP39—50 FET PROJECTS \$5.50. Projects include ir amplifiers & converters, test equipment, receiver aids, tuners, receivers and more.



BP127—HOW TO DESIGN ELECTRONIC PROJECTS \$5.75. How to use standard circuit elements to make custom electronic projects.



BP110—HOW TO GET YOUR ELECTRONIC PROJECTS WORKING \$5.00. How to find the faults in your projects, repair them and get them working.



BP121—DESIGN & MAKE YOUR OWN PC BOARDS \$5.75. Everything you need to know before you make printed-circuit boards for your projects.



BP56—ELECTRONIC SECURITY DEVICES \$5.00. Three basic sections. Switch activated alarms, infrared & ultrasonic systems, smoke, gas, water detection.



BP85—INTERNATIONAL TRANSISTOR EQUIVALENTS \$7.50. Locates possible substitutes for a popular user-oriented selection of modern transistors. Japanese, European and American types.



BP117—PRACTICAL ELECTRONIC BUILDING BLOCKS, Book 1 \$5.75. Build the blocks and then combine them to form almost any custom project of your choice.



BP118—PRACTICAL ELECTRONIC BUILDING BLOCKS, Book 2 \$5.75. Amplifiers for all kinds to add to the circuits from Book 1 of this series.

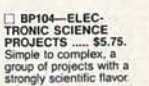

BP92—CRYSTAL SET CONSTRUCTION \$5.00. A variety of crystal radio receivers for the experimenter and hobbyist.

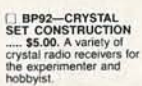

BP77—MICRO-PROCESSING SYSTEMS AND CIRCUITS \$5.95. Guide to the elements of micro-processing systems. Teaches all the fundamentals.



BP169—HOW TO GET YOUR COMPUTER PROGRAMS RUNNING \$5.95. Have you ever written your own programs only to find that they do not work? This book shows you how to find errors.

Affordable Prices



BP128—30 PROGRAMS FOR THE ZX SPECTRUM & 16K ZX81 \$5.75. All programs run on both machines. Include flow charts and info on how to modify to run on other computers.



BP106—MODERN OP-AMP PROJECTS \$5.00. Includes a Slide Timer, AF Signal Gen, Mike Pre-amp, Scratch Filter, and much more.



BP99—SECOND BOOK FOR CMOS IC PROJECTS \$5.00. Multivibrators, amplifiers, Triggers & gates; special devices including reaction timer, simple electronic organ, and more.



BP182—MIDI PROJECTS \$6.95. Details of how to interface many popular home computers with MIDI music systems.

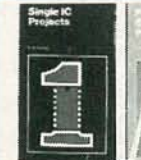

BP65—SINGLE IC PROJECTS \$4.95. All projects in this book are based on one IC and are simple to construct. Great way to get started with IC's.



BP49—POPULAR ELECTRONIC PROJECTS \$5.50. A collection of a wide range of electronic projects and circuits for the experimenter.



BP97—IC PROJECTS FOR BEGINNERS \$5.00. Written especially for the less experienced experimenter. Complete parts layouts and wiring diagrams.



BP80—POPULAR ELECTRONIC CIRCUITS, Book 1 \$5.00. More circuits for hobbyists. Audio, radio, test, music, household and more.

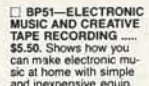

BP51—ELECTRONIC MUSIC AND CREATIVE TAPE RECORDING \$5.50. Shows how you can make electronic music at home with simple and inexpensive equin

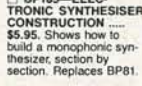

BP185—ELECTRONIC SYNTHESISER CONSTRUCTION \$5.95. Shows how to build a monophonic synthesizer; section by section. Replaces BP81.

CHECK OFF THE BOOKS YOU WANT

ELECTRONIC TECHNOLOGY TODAY INC.
P.O. Box 240, Massapequa Park, NY 11762-0240

SHIPPING CHARGES IN USA & CANADA
\$0.01 to \$5.00 . . . \$1.00
\$5.01 to \$10.00 . . . \$1.75
\$10.01 to 20.00 . . . \$2.75
\$20.01 to 30.00 . . . \$3.75
\$30.01 to 40.00 . . . \$4.75
\$40.01 to 50.00 . . . \$5.75
\$50.01 and above . \$7.00

OUTSIDE USA & CANADA
Multiply Shipping by 2 for sea mail
Multiply Shipping by 4 for air mail
Total price of merchandise . . . \$
Sales Tax (New York State Residents only) . . . \$
Shipping (see chart) . . . \$

Number of books ordered
Total Enclosed . . . \$

Name _____
Address _____
City _____ State _____ Zip _____

RE17

All payments must be in U.S. funds

5-VOLT ONLY: INTRODUCING THE NEW MAX 232

Something new on the horizon...

Rodney A. Kreuter

■I've wound my last DC-DC transformer, built my last 555 voltage doubler/inverter. Thanks to a new chip, the MAX232, from Maxim Integrated Products, all that's a thing of the past.

Ever since the 2716 replaced the 2708 EPROM, bipolar power supplies have been very rare in the digital world - except when an RS-232 interface was required. Every IC manufacturer has strived to make UARTS, RAM, EPROMS, and CPUs five volt only parts. However, since RS-232 is an EIA standard, nothing could be done to change its requirements for bipolar signals.

RS-232 defines a "1" as a voltage between -3 and -27 volts. A "0" is defined as a voltage between 3 and 27 volts. Notice that a voltage between -3 and 3 volts has no meaning in RS-232. It is not a "1" or a "0." For this reason it is called the "dead band."

Some manufacturers cheat RS-232 because of two popular chips that have been used for years to make up an RS-232 interface—the 1488 and 1489. Many manufacturers produce these chips with a different prefix. For example Motorola calls them the MC1488L and MC1489L.

The 1488 is the line driver. When powered by +12 and -12 volts, it converts a TTL signal to a proper RS-232 level. As a matter of fact, it will just barely meet the RS-232 standard levels when powered by +5 and -5 volts, although no specifications are given by Motorola for any operation below +6 and -6 volts. Noise immunity suffers from powering the chip with less than ± 12 volts as does the maximum distance the signal can travel, so most people stick to ± 12 volts. The 1489 line receiver is where the idea to cheat RS-232 begins. The 1489 has an adjustable 'threshold'.

This threshold is the voltage at which a "1"/"0" decision is made. It can be set to any voltage between -3 and +3 volts. The default setting (which 75% of the manufacturers use) is about 1 volt. This means that anything below a volt will be read as a "1" and anything above a volt as a "0" (note the negative logic). Since normal TTL signals swing from 0.8 to 2.4 volts, why bother to use the 1488 at all? Because some manufacturers do use the threshold adjust and set it to -3 or +3 volts! Anyway 0.8 volts is just barely below 1 volt and operation can be marginal.

To sum it up simply, before the MAX232, in order to be sure of meeting the RS-232 standard you needed a bipolar power supply to obtain the negative voltage to power the 1488.

The MAX232 changes all that by providing a proper RS-232 level from only +5 volts. It contains a +5 to +10 volt voltage doubler, a +10 to -10 volt inverter, two line drivers (TTL to RS-232 converters), and two line receivers (RS-232 to TTL converters). In its basic configuration it requires four low-cost capacitors as shown in figure 1. Adding a second chip to increase the number of RS-232 lines requires two MAX232 chips and six capacitors as shown in figure 2.

The value and type of capacitors used will depend on your application and can best be explained by the Maxim Integrated Products data sheet:

"The MAX232 power supply section contains two charge pumps. The first uses external capacitor C1 to double the +5V input to +10V, with an output impedance of approximately 200 ohms. The second charge pump uses external capacitor C2 to invert the +10V to -10V, with an overall output impedance of 450 ohms (including the effects of the +5 to +10

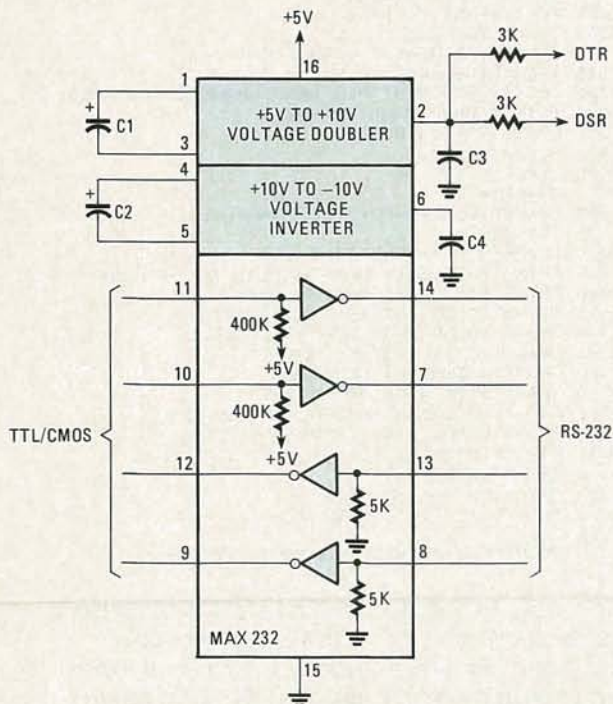

Fig. 1—FOUR LOW-COST CAPACITORS are needed in the basic configuration shown above.

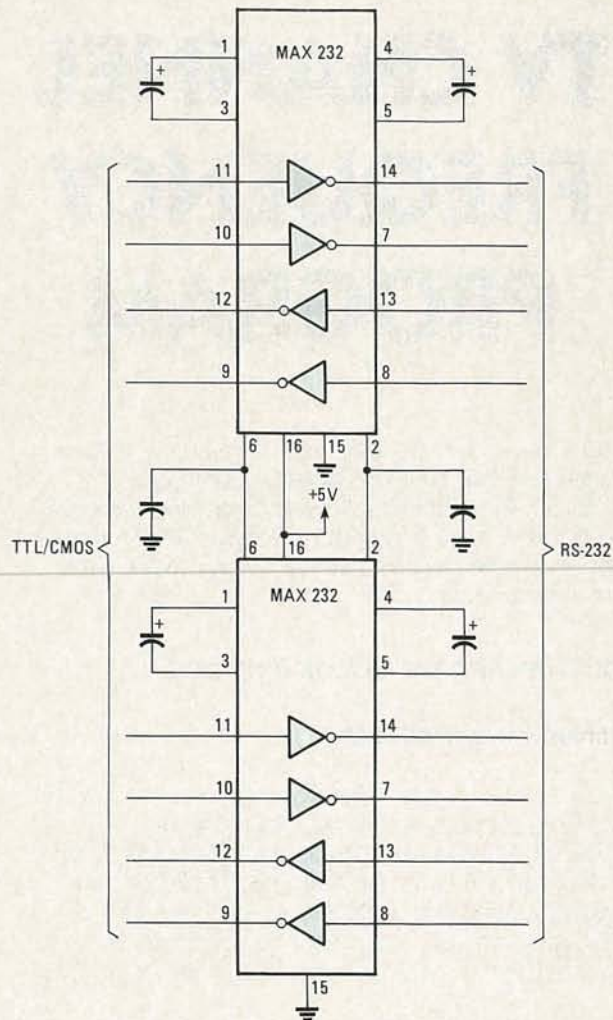



Fig. 2—ADDING A SECOND CHIP to increase the number of RS-232 lines requires two MAX232 chips and six capacitors.

voltage doubler impedance).

The test circuit uses 22 μ F capacitors for C1-C4, but the value is not critical. Normally these capacitors are low cost aluminum electrolytic capacitors, or tantalum if size is critical.

Increasing the value of C1 and C2 to 47 μ F will lower the output impedance of the +5V to +10V doubler by about 5 ohms and the +10V to -10V inverter by about 10 ohms. Increasing the value of C3 and C4 lowers the ripple on the +/- 10V power supplies, thereby lowering the 16kHz ripple on the RS-232 outputs. The value of C1-C4 can be lowered to 1 μ F in systems where size is critical, at the expense of an additional 20 ohms impedance in the +10V output, 40 ohms additional impedance at the -10V output, and 250mv of 16kHz ripple on V-."

The MAX232 can be purchased directly from the factory at: Maxim Integrated Products, 510 N. Pastoria Ave., Sunnyvale, Ca. 94086, (408)737-7600. It can also be obtained through these nationwide distributors: Bell Industries, Diplomat, Hallmark.

Price quotes for the commercial package as of January 6th, 1986 are: 1 - 24 pieces, \$5.40 each; 25 - 99 pieces, \$4.32 each; 100+ pieces, \$3.60 each. 

TV CHANNEL FREQUENCY PROGRAM

Back in October of 1986, we published the following program on TVRO antenna pointing using your computer. The mail that followed complained that we had published the wrong story. Not true! The story was right, it was the program that was wrong. In any case, here it is, corrected.

You'll never have to look it up again...

Michael Kiley, WA9ZPM

■ Did you ever wonder what frequency your favorite TV channel broadcasts on? Did you ever have to troubleshoot master antenna or cable TV equipment? Or diagnose TVI complaints and need to know the frequency range of the affected channels? Here is a BASIC program, easily adaptable to any home computer, that will give you the frequencies of any VHF

```

TV CHANNEL FREQUENCY DIRECTORY
*****
ENTER TV CHANNEL: 2
FREQUENCY RANGE= 54 TO 60 MHZ.
PIX CARRIER= 55.25 MHZ.
COLOR CARRIER= 58.83 MHZ.
SOUND CARRIER= 59.75 MHZ.
NOTE: THE FOLLOWING
ASSUMES A RECEIVER
WITH A 41-47MHZ I.F.
(41.25MHZ SOUND, 45.75MHZ PIX.)
LOCAL OSCILLATOR= 101 MHZ.
IMAGE RANGE= 142 TO 148 MHZ.
MORE?Y
*****
ENTER TV CHANNEL: 7
FREQUENCY RANGE= 174 TO 180 MHZ.
PIX CARRIER= 175.25 MHZ.
COLOR CARRIER= 178.83 MHZ.
SOUND CARRIER= 179.75 MHZ.
NOTE: THE FOLLOWING
ASSUMES A RECEIVER
WITH A 41-47MHZ I.F.
(41.25MHZ SOUND, 45.75MHZ PIX.)
LOCAL OSCILLATOR= 221 MHZ.
IMAGE RANGE= 262 TO 268 MHZ.
MORE?Y
*****
ENTER TV CHANNEL: 13
FREQUENCY RANGE= 210 TO 216 MHZ.
PIX CARRIER= 211.25 MHZ.
COLOR CARRIER= 214.83 MHZ.
SOUND CARRIER= 215.75 MHZ.
NOTE: THE FOLLOWING
ASSUMES A RECEIVER
WITH A 41-47MHZ I.F.
(41.25MHZ SOUND, 45.75MHZ PIX.)
LOCAL OSCILLATOR= 257 MHZ.
IMAGE RANGE= 298 TO 304 MHZ.
MORE?Y

```

or UHF TV channel, as well as cable channels 14 through 36 or A through W. After entering and loading the program and RUNNING it, simply type the desired TV channel number or letter, followed by a <return>. When entering channels above 13, the prompt "UHF OR CABLE?" will appear. Type U or UHF for UHF, or C or CABLE for a cable channel, followed by a <return>. Immediately, a list of the channel band limits, picture, color and sound carrier limits will appear. Assuming the receiver or converter has a standard 41-47MHz IF, the local oscillator and image response frequencies will be given. Virtually all TV sets made after 1960 use this IF but some top-of-set UHF and cable converters heterodyne the incoming frequency directly to the output channel, which becomes its IF. In such cases, make the following changes:

430 FL = ABS(LB-(output channel lower range limit))
 440 IL = ABS(LB-(output channel lower range limit)*2):IU = ABS(UB-(output channel upper range limit)*2)

500 PRINT "IS FOR A CONVERTER"
 510 PRINT "WITH AN OUTPUT ON CHANNEL (number of output channel)" Delete line 515.

```

10 PRINT"TV CHANNEL FREQUENCY DIRECTORY"
20 PRINT"*****"
30 PRINT"ENTER TV CHANNEL: ";
35 INPUTA$
40 A=ASC(A$):IFA>64THEN300
50 C=VAL(A$)
100 IFC<2THEN600
110 IFC<5THEN200
120 IFC<7THEN190
130 IFC<14THEN180
140 PRINT"UHF OR CABLE";
145 INPUTB$
150 IF LEFT$(B$,1)="C"THEN320
160 IFC>83THEN600
170 BC=14:BF=470:GOTO400
180 BC=7:BF=174:GOTO400
190 BC=5:BF=76:GOTO400
200 BC=2:BF=54:GOTO400
300 IFA>90THEN600
310 C=A-51:PRINTA$;" =CABLE CH# ";C
320 IFC>40THEN600
330 IFC<23THENPRINT" MID BAND CHANNEL":GOTO360
340 PRINT" SUPER BAND CHANNEL"
350 BC=23:BF=216:GOTO400
360 BC=14:BF=120
400 LB=BF+(C-BC)*6
410 UB=LB+6
420 FV=LB+1.25:FC=FV+3.58:FA=FV+4.5
430 FL=LB+47
440 IL=UB+41*2:IU=LB+47*2
450 PRINT" FREQUENCY RANGE=";LB;" TO ";UB;" MHZ."
460 PRINT" PIX CARRIER=";FV;" MHZ."
470 PRINT" COLOR CARRIER=";FC;" MHZ."
480 PRINT" SOUND CARRIER=";FA;" MHZ."
490 PRINT" NOTE: THE FOLLOWING"
500 PRINT" ASSUMES A RECEIVER"
510 PRINT" WITH A 41-47MHZ I.F."
515 PRINT" (41.25MHZ SOUND, 45.75MHZ PIX.)"
520 PRINT" LOCAL OSCILLATOR=";FL;" MHZ."
540 PRINT" IMAGE RANGE=";IL;" TO ";IU;" MHZ."
550 PRINT" MORE?";
560 GETC$:IFC$=" "THEN560
570 PRINTC$:IFC$="Y"THEN20
580 END
600 PRINT"NON-EXISTENT CHANNEL":GOTO20

```

The correct values for the converter's output channel must be substituted for the lower-case words in parentheses. Because the converter's local oscillator must operate below the incoming signal frequency instead of above it, as in a TV, the equations are somewhat different. ◀▶

ALL ABOUT INTERFACING PART II

JEFF HOLTZMAN

This article, begun last month, is concluded here.

RS-232

In 1969 the EIA (Electronics Industries Association) revised the standards defining timing sequences, voltage levels, and pin designations for serial data transmission. That standard is known as RS-232-C. We will refer to it here as RS-232. The specifications are complex, and many companies alter them—seemingly at random—to suit their own needs, without paying attention to the details. We will discuss some of the uses of RS-232 with microcomputers and common peripherals, rather than the technical specifications.

RS-232 signals are bi-polar; that is, a logical "low" is a voltage below ground, and a "high" is a voltage above ground. These voltages must be equal in magnitude and opposite in polarity. They may range from ± 3 to ± 25 volts, and ± 12 volts is very commonly used in microcomputers. The inactive state of an RS-232 line is low. A low signal is called a space, and a high signal, a mark.

You can implement an RS-232 interface with only 2 wires: a signal and a ground, but the sending software might need to provide delays after characters that cause operations like returning the carriage to the left side of the page, feeding the paper up a line, or feeding a whole page through the printer. Such schemes are used when the timing sequences are well defined, but most consumer equipment makes use of one or more of the hardware or software transmission regulation schemes discussed last time.

Many RS-232 interfaces include other signals with names like CARRIER DETECT, DATA TERMINAL READY, etc. (See Fig. 7.) Many of these signals were developed for use with MODEMs, and were meant to indicate presence on the telephone line of the ringing voltage, special timing signals, secondary transmit and receive lines used for diagnostic functions, etc. Many manufacturers didn't follow the "standards," and started putting all kinds of things on the connector, including power for peripheral devices. For interface devices like printers,

most of those signals aren't used, though some may have to be accounted for.

The "Busy" line is commonly (but not always) available at pin 20 of a 25 pin "D" connector, which is the DTR line. DTR is an acronym for "Data Terminal Ready," and on some machines that signal indicates that the machine has been powered up, whether it is able to receive data or not. The Busy signal also may come on pins 4, 6, 8, 11 or 19. That is usually documented—but not always, and you may have to experiment to find out which is the busy line. The only things you can be certain of are that pin 7 is circuit ground, pin 1 is

Figure 7
RS-232-C DTE Pin Designations

Pin	Acronym	Description
1	PG	Protective Ground
2	TD	Transmitted Data
3	RD	Received Data
4	RTS	Request To Send
5	CTS	Clear To Send
6	DSR	Data Set Ready
7	GND	Ground
8	RLSD	Received Line Signal Detect
9		Test Pin
10		Test Pin
11		Unassigned (sometimes used for Busy line)
12	SCF	Secondary Received Line Signal Detect
13		SCB Secondary Clear To Send
14	SBA	Secondary Transmitted Data
15	DB	Transmitter Timing
16	SBB	Secondary Received Data
17	DD	Receiver Timing
18		Unassigned
19	SCA	Secondary Request To Send
20	DTR	Data Terminal Ready
21	CG	Signal Quality
22	CE	Ring Indicator
23	CH/CI	Data Rate Selector
24	DA	Transmit Timing
25		Unassigned

FIG. 7—EIA DESIGNATIONS for a standard RS-232 port.

frame ground, and pins 2 and 3 will be input and output pins.

Part of the EIA standard are the two acronyms, DTE and DCE. The former stands for Data Terminal Equipment, and the latter for Data Communications Equipment. The technical specifications are complex, but their meaning is that input and output pins are reversed on the two kinds of equipment. Connecting cables could be wired straight across. Computers usually use pin 2 as the data output pin, and pin 3 as the data input pin. MODEMs reverse those pins so pin 2 on one device may be wired directly to pin 2 on the other; likewise with pin 3.

Printers are (usually) connected as DTE devices, so to connect a DTE computer port to a printer may require that pins 2 and 3 be cross connected (2 to 3 and 3 to 2). To use the same computer port at different times with both a printer and a MODEM usually requires some sort of wiring adapter on one device to reverse the transmit and receive data pins.

A cable which cross-connects inputs and outputs is commonly called a "null-MODEM," named because it replaces two MODEMs connected back to back. If we connected each signal line straight across, inputs would go to inputs, and outputs would go to outputs. That wouldn't do, so it was necessary to cross-connect inputs and outputs. To account for all the MODEM

control signals we would have to wire a cable as shown in Fig. 8a or Fig. 8b. Often we can cross the TD or RD lines as shown in Fig. 8c, and ignore the rest. It is often desirable to connect the serial ports of two personal computers together and use a special program to transfer files between them. Such communications programs frequently use software "Busy" protocols and simply ignore "Busy" pins. If so, the 3-wire configuration shown in Fig. 8c would suffice.

Don't get hung up on the terminology. To wire up interface cables for microcomputers and peripherals, think functions, and ignore the EIA's confusing designations. Many microcomputer interfaces can get by using only TD, RD, GND and BUSY lines between the two devices. Determine which is which on each device using the manufacturer's documentation, or with test equipment. Other lines may often simply be tied high or ignored. Unless you have a reason for including the other lines, ignore them until you have a reason not to.

Hints for debugging serial interfaces

Suppose now that you have just bought a brand new printer from the Chopstick Printer Company of Hong Kong, and all it comes with is a diagram of the output connector—maybe not even that. How would you go about hooking it up to your personal computer?

First get all documentation for both pieces of equipment. Use those documents to draw a diagram (like that shown in Fig. 5 last time) with similarly labeled signals laid out opposite each other. Draw in lines connecting the important signals: RD, TD, GND and BUSY, showing pin numbers at both ends. Check everything over—there is nothing more disheartening than frying a brand-new printer—then wire up a cable using a "break-out" box and the appropriate connectors. Connect the two pieces of equipment.

What if you have no documentation, or have hooked things up according to the manufacturers suggestions—and it doesn't work? Build a test instrument like that shown in Fig. 9. Use a "Tri-color" LED, as it will allow you to see highs, lows and streams of data in different colors. Attach a tiny alligator clip to the resistor and a sharp probe to the LED. Connect the clip to pin seven (ground) of the computer, and turn the power on.

Examine pins two and three. One should be an input and one an output. The output will cause the LED to glow, and the color it glows indicates a low. Record which pin caused the LED to glow, and the color it

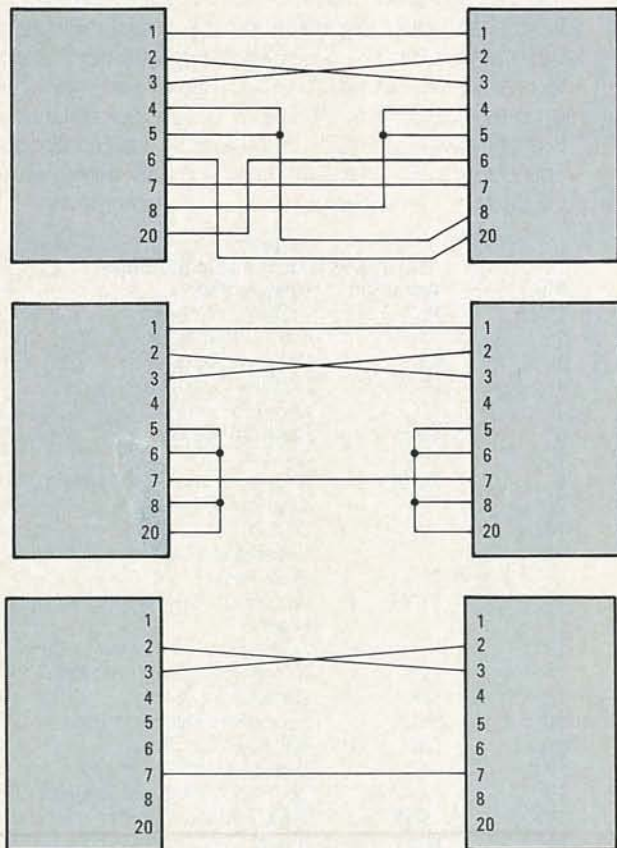

FIG. 8—THREE DIFFERENT NULL-MODEM cables are shown here. Those at a and b use the MODEM control lines, and the one at c is a simple computer-to-computer hook-up. What they have in common is a reversal of the main data lines, pins two and three.

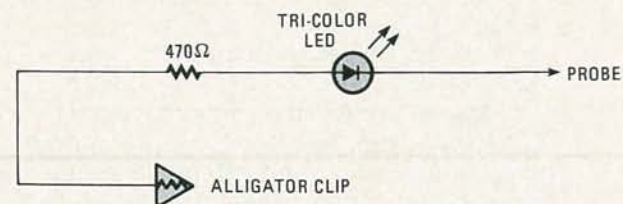

FIG. 9—THIS CIRCUIT comes in handy for debugging both parallel and serial interfaces. Use a tri-color LED for best results.

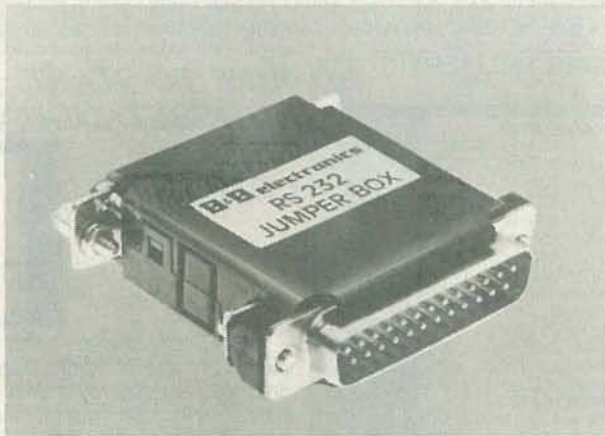

FIG. 10—This “D” connector shell is handy for wiring up RS-232 interface adapters. See the text for more information.

glowed. Repeat the process on the printer, recording everything. You can assign some pin numbers. The output of the computer should connect to the input of the printer, and vice versa. Don't forget to connect pins 7 on both devices together.

You'll have to decide on the “Busy” protocol you'll be using, i.e., hardware or software. If you have no reason for either, choose software, as it's more universal, so the same port could be used with both a MODEM and a printer, without having to re-configure.

If you go the hardware route you'll have to find the busy signal. With a printer, that's not too difficult. Connect your probe to pins 7 and 20. Note the color of the LED, then press the printer's “ON-LINE” switch. If the LED changes color, there's a chance you've found the Busy line. If the LED didn't change colors, try pins 4, 5, 6, 8, 11 or 19. Failing that, try all other pins one by one. Failing that, you'll have to contact your supplier or the manufacturer—and good luck with the latter!

You won't be able to use the LED probe to find the Busy input to your computer because, since it is an input, it won't make the LED glow. If you don't have it in your system documents, try pin 20. But first make sure that pin is not an output. If it is an output, try working with the other pins mentioned. Do so systematically, writing down your findings at each step. As frustration increases, we are increasingly likely to forget what we've already done. Remember, outputs go to inputs, and vice versa.

After all wires are connected, (at least tentatively), you'll need to make sure your computer knows that you have hooked the printer up. We can't stress the importance of this step; if we had a dollar for every interfacing problem we helped debug that eventually turned out to be a case of the computer's simply not knowing the device had been attached—we'd be writing this from a villa on the Riviera! Anyway, for CP/M systems you'll use the STAT command or a custom utility supplied by the manufacturer of your machine. MS-DOS machines will use the MODE command, or, again, a custom utility.

Let's do this a step at a time. First let's see if we can get just one character to the printer. Use the quickest method you have for getting a character to the device.

CP/M and MS-DOS owners can type a CNTL-P followed by some data (assuming the printer is set up as the normal LST: or PRN device.) The printer should print everything you type at the keyboard until your next CNTL-P. Apple, Commodore and Sinclair owners will find using BASIC the simplest way of experimenting. Just use LPRINT statements like the following (don't forget the semicolon):

10 LPRINT “A”;

Let's assume you sent one character to the printer. If it printed correctly, try sending another. If that works, try sending a number of characters, and follow them with a CRLF. In BASIC use:

10 LPRINT “EVERY GOOD BOY DOES FINE”

If nothing at all is printed, but the computer doesn't lock up (or, in MS-DOS, you don't get the “Abort, Retry, Ignore?” message), chances are the computer is sending data out some other port, and doesn't realize you're hooked up. If you end up having to re-boot (Reset) your machine a few times while experimenting, don't forget to initialize the port each time.

If garbage is printed, you probably have a Baud rate or protocol problem. Unless you have a specific reason not to, set both your computer and your printer up to operate with one start bit, eight data bits, one stop bit, and no parity. And if you are using a software protocol, make sure both devices use the same protocol. You can't run the computer with ETX/ACK and the printer with X-ON/X-OFF!

If your printer locks up after the first (sometimes second) character, you most likely have a Busy line problem. After sending each character the computer looks for some acknowledgement that it is safe to continue, and it may just loop forever waiting for a “high” at its busy input. To solve that problem, find a signal that appears to remain high and try connecting it to the pins you know are inputs (to the computer port), one by one, again writing down what happens at each

**Table 1
Debugging a Microcomputer Interface**

1. Get all relevant documents for both machines
2. Decide on hardware or software “Busy” protocol
3. Assign and configure computer port (1 start and 1 stop bit, 8 data bits, no parity, unless specifically need other.)
4. Configure peripheral port exactly the same as printer port.
5. Make wiring diagram.
6. Assign pin numbers:
 - A. Use documents, if available, otherwise
 - B. Use LED tester to determine all outputs on both machines, especially TD, DTR, RTS.
7. Wire up most likely configuration using breakout box.
8. Get one character to transmit without locking up computer. If incorrect data prints, baud rate probably incorrect. If nothing prints, possible wiring error or port incorrectly configured. Use spare video terminal, if available, to verify data is being transmitted.
9. Get a second character to transmit. If computer locks up, probably busy line is not properly connected. Don't forget to re-initialize port.
 - A. Busy line should toggle each time “ON-LINE” switch is pressed.
 - B. Problem may be with MODEM lines (4, 5, 6, 8). Try tying high, singly and in combination, if necessary.
10. Print a couple of lines. If that works, print a several-page document. If data is lost, “Busy” line not working.

R-E Computer Admart

Rates: Ads are 2 1/4" x 2 7/8". One insertion \$825. Six insertions \$800 each. Twelve insertions \$775. each. Closing date same as regular rate card. Send order with remittance to **Computer Admart**, Radio Electronics Magazine, 500-B Bi-County Blvd., Farmingdale, NY 11735. Direct telephone inquiries to Arline Fishman, area code-516-293-3000. **Only 100% Computer ads are accepted for this Admart.**

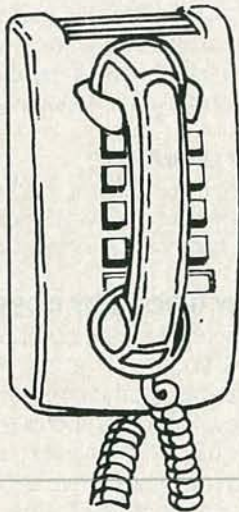

CALL NOW AND RESERVE YOUR SPACE

- 6 x rate \$800.00 per each insertion.
- Reaches 239,312 readers.
- Fast reader service cycle.
- Short lead time for the placement of ads.

Call 516-293-3000 to reserve space. Ask for Arline Fishman. Limited number of pages available. Mail materials to: Computer Admart, RADIO-ELECTRONICS, 500-B Bi-County Blvd., Farmingdale, NY 11735.

ICs PROMPT DELIVERY!!!

SAME DAY SHIPPING (USUALLY)
QUANTITY ONE PRICES SHOWN FOR NOV. 2, 1986

OUTSIDE OKLAHOMA: NO SALES TAX

DYNAMIC RAM		
1Mbit	1000Kx1	100 ns \$40.00
4464	64Kx4	150 ns 3.75
41256	256Kx1	100 ns 4.85
41256	256Kx1	120 ns 3.10
41256	256Kx1	150 ns 2.60
41128	128Kx1	150 ns 4.99
4164	64Kx1	150 ns 1.35
EPROM		
27512	64Kx8	250 ns \$22.00
27C256	32Kx8	250 ns 5.85
27256	32Kx8	250 ns 5.25
27128	16Kx8	250 ns 3.95
27C64	8Kx8	200 ns 4.75
2764	8Kx8	250 ns 3.85
STATIC RAM		
43256L-12	32Kx8	120 ns \$22.00
6264LP-15	8Kx8	150 ns 2.99

OPEN 6 1/2 DAYS, 7 AM-9 PM SHIP VIA FED-EX ON SAT.

SUNDAYS & HOLIDAYS: SHIPMENT OR DELIVERY VIA U.S. EXPRESS MAIL.

SAT DELIVERY INCLUDED ON MasterCard VISA or UPS CASH COD

FED-EX ORDERS RECEIVED BY: **Factory New, Prime Parts** 

Microprocessors Unlimited, Inc.

24,000 S. Peoria Ave. (918) 267-4961

BEGGS, OK 74421 No minimum order

Please call for current prices because prices are subject to change! Shipping & insurance extra. Cash discount prices shown. Orders received by 9 PM CST can usually be delivered to you the next morning, via Federal Express Standard Air - \$6.00, or Priority One - \$13.00.

CIRCLE 61 ON FREE INFORMATION CARD

COMPUTER ASSEMBLY MANUALS



Eliminate Guesswork!
Build with Confidence!

BIG BLUE SEED for IBM™ BUILDERS
Parts list, placement diagrams & instructions for assembling over 75 IBM-compatible bare cards. Latest version includes guides for 640K, Turbo, & AT MthBds. \$19.95

APPLE SEED II for APPLE™ BUILDERS
Instructions for assembling over 85 Apple-compatible bare cards including II+ & IIe MthBds. For all Apple enthusiasts .. \$14.95

Both for \$30.00! Also bare cards in stock!
Check/money-order, VISA/MasterCard to:

NuScope Associates*, Dept RE
P.O. Box 790 • Lewiston, NY • 14092

*A Division of Kosmic MicroTech Inc.

CIRCLE 205 ON FREE INFORMATION CARD

HOW TO START UNDERSTANDING THE COMPUTER



—This book should help you learn more about the computer than you ever dreamed. It clearly explains hardware, software, the electronics of, and more by relating each to something familiar. You profit, because you quickly use what you learn. Enter a new money making career or enhance your present one. To order your copy send **\$12.95 plus \$1.00 shipping** in the U.S.A. to Eclectical Publishing Co., Inc., P.O. Box 7326, New Orleans LA. 70186.

CIRCLE 206 ON FREE INFORMATION CARD

A Z-80 WORKSHOP MANUAL



Starting with a review of computer principles, this book describes typical machine-code instructions followed by a detailed description of the Z-80 instruction set. Assembly language programming is also discussed with examples. Z-80 hex machine-code and assembler instructions are given in tabular form, along with in-our connections for the Z-80 and te associated devices.... Order your copy from **Electronic Technology Today Inc.**, PO Box 240, Massapequa Park, NY 11762. Price is \$6.95 plus \$1.00 for shipping.

step. After making each connection, check if the computer has "unlocked," that is, whether you can type something at the keyboard.

If tying single lines high doesn't solve the problem, you may have to tie several lines high. MODEM control pins 4, 5, 6 and 8 are particularly likely candidates for that treatment. Try connecting them to pin 20.

After you've gotten the "Busy" line working, try printing a document several pages long. It may be that, even though the computer didn't "lock up," the "Busy" line wasn't doing its job. If, after successfully printing a part of your document, other parts seem to be lost, the printer is missing data from the computer because the computer is not reading the "Busy" line. The information presented in this section has been summarized in Table 1. Cut it out and paste it up near your workbench so you can refer to it when you need it.

If you need more help, human resources are the best. Try local computer clubs, or computer stores. Many

electronic bulletin boards have special interest groups for people with various equipment. You might try leaving a "HELP!" message on a bulletin board with appropriate special interest groups.

For more technical information on the RS-232 standard, a good place to start is a book called *RS-232 Made Easy* by Martin D. Seyer (Prentice Hall: 1984). Seyer gives a good discussion of the MODEM control lines, summarizes the EIA standards, and lists, in several appendices, output connectors and interconnections for several hundred popular computers and printers. No MODEMs are included in the charts, however.

A good source for RS-232 adapter cables and test equipment is B & B Electronics, P.O. Box 1008H, Ottawa, IL 61350. They manufacture a very useful, yet quite inexpensive (\$1.75) "D" connector shell (Model 232CS). As shown in Fig. 10, one or two 25-pin "D" connectors may be mounted in the 232CS, and that allows very neat do-it-yourself adapters to be made. 

ANTIQUA RADIO

continued from page 78

ed to use selenium rectifiers. If you do replace a tube with a selenium rectifier, use one with a rating of at least 100 ma.

Many portables use miniature tubes. Those tubes are electrically similar to their predecessors; the main difference is their size. Care should be taken to protect their fragile filaments.

The Motorola set shown in Fig. 3 uses a large "GT" tube that was introduced in 1939 and that remained popular for about 15 years. The tube complement is two 1N5's, and one each 1A7, 1H5, 3Q5, plus the 117Z6. Notice that the tubes numbers beginning with a "1" have a filament voltage of 1.4 volts, and a current of 50 ma. All those battery-operated tubes are filament types in which the filament emits the electrons, not the cathode. Some three-volt tubes are center tapped and can require 1.5- or 3-volts DC.



FIG. 3

Miscellaneous info

There were RETMA (Radio Electronics Television Manufacturing Association) standards for battery plugs and receptacles. The standard was designed to prevent you from plugging the wrong battery into a circuit. But, like many "standards" in the electronics industry, there is no guarantee that all manufacturers adhered to it.

Most old portables have a line-cord safety interlock to disconnect power when the back cover is removed. Most servicemen know how to get around the interlock, and often cause more damage than good. Even a knowledgeable radioman can damage tubes by a moment of carelessness. R-E

STATEMENT OF OWNERSHIP, MANAGEMENT AND CIRCULATION	
Name of publication	Radio Electronics
Issue date for circulation data below	October 1987
Issue frequency	Monthly
Number of copies of this issue actually produced	12,000
Number of copies distributed outside the United States	12,000
Number of copies distributed within the United States	12,000
Number of copies of this issue actually sold (including sales through dealers and carriers, street vendors and counter sales)	12,000
Number of copies of this issue distributed by other classes of mail	0
Number of copies of this issue not distributed	0
Total	24,000
Number of copies of this issue not distributed	0
Total	24,000
Number of copies of this issue actually produced	12,000
Number of copies distributed outside the United States	12,000
Number of copies distributed within the United States	12,000
Number of copies of this issue actually sold (including sales through dealers and carriers, street vendors and counter sales)	12,000
Number of copies of this issue distributed by other classes of mail	0
Number of copies of this issue not distributed	0
Total	24,000
Number of copies of this issue not distributed	0
Total	24,000
Number of copies of this issue actually produced	12,000
Number of copies distributed outside the United States	12,000
Number of copies distributed within the United States	12,000
Number of copies of this issue actually sold (including sales through dealers and carriers, street vendors and counter sales)	12,000
Number of copies of this issue distributed by other classes of mail	0
Number of copies of this issue not distributed	0
Total	24,000
Number of copies of this issue not distributed	0
Total	24,000

Experience the wonder... of fischertechnik® kits

Learn about:



Explore other fascinating concepts like Robotics, Hydraulics, Statics, and more!



We make a variety of easy-to-build, educational kits, from the simple to the complex. For ages 6 and up. For learning that's fun.

Available at your Heath/Zenith Computers & Electronics Center. See your telephone white pages for the store nearest you. Or order from the Heathkit Catalog. To order by phone, call 1-800-253-0570.



fischertechnik®



DRAWING BOARD

Remote-control transmitter

IT'S AMAZING HOW QUICKLY THINGS change. My first experience with DTMF (Dual Tone Multi-Frequency) was at the 1964/65 World's Fair in New York City. The telephone company had managed to modify a local exchange to use tone dialing and the fair grounds were dotted with prototypes of pushbutton pay phones. It was the first time they were seen and people lined up to use them.

Tone generation and detection was a nightmare back then. The circuits needed to produce accurate tones were both complex and touchy. And detection was even more difficult. Integrated circuitry made it a bit easier because general-purpose IC's like the 567 could be set up to decode particular frequencies. But it was all analog, and component drift, due to aging and temperature changes, made the circuitry less than ideal.

The digital revolution has simplified the generation of DTMF tones. The IC we're going to use, AMI's 2579, has everything you need to generate DTMF tones built right in the IC, and believe me—that's a far cry from the old days. The only external components needed are a crystal and a resistor.

We showed the 2579's pinout last time, but neglected to explain how it works. We'll do that in a moment, but first let's take a minute to talk about DTMF in general.

Tone generation

The DTMF tones are a series of discreet frequencies broken into two groups of tones—the high group and the low group. Figure 1 shows how each column and each row of a telephone keypad is asso-

		HIGH GROUP			
		1209 Hz	1336 Hz	1477 Hz	1633 Hz
LOW GROUP	697 Hz	1	2	3	A
	770 Hz	4	5	6	B
	852 Hz	7	8	9	C
	941 Hz	*	0	#	D

FIG. 1

ciated with a tone of a particular frequency. There are eight tones, four per group. By arranging them in a 4 × 4 matrix, sixteen combinations are possible. Standard telephones use only seven of the available tones, but most DTMF IC's generate all eight. Table 1 shows how connecting various 2579 inputs high and low in various combinations produces various output tones.

When you push a button on a telephone keypad (or any keypad that uses the DTMF system), the circuit produces two tones, one each from the corresponding row (high group) and column (low group). When those tones are received, the receiving circuit must split the incoming audio into separate high- and low-group tones before it's able to decide which key you pressed. And, although DTMF decoding has become much easier, due to the use of special digital IC's, detecting the tones is still more complex than generating them.

Generating DTMF tones with AMI's 2579 is incredibly simple. As you can see in Fig. 2, the output of the keyboard circuit we put together last time is connected to the row inputs (pins 11-14) of the 2579; the column inputs (pins 3, 4,



ROBERT GROSSBLATT,
CIRCUITS EDITOR

5, and 9) are left floating. We can let the column inputs float, because they're tied high by internal 50K resistors. The colorburst crystal and the 10-megohm resistor are paralleled across pins 10 and 11, the chip's oscillator inputs. And that's all there is to it.

The output of the IC is DC emitter coupled; it is designed to drive a 120-ohm load. As the circuit stands, pressing a key will cause a signal composed of the two DTMF frequencies to show up at the output. In order for everything to work properly, however, we must take account of two additional pins of the 2579.

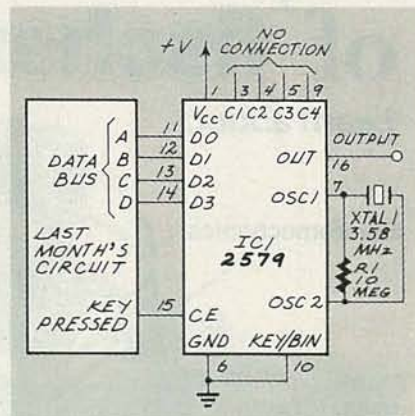

FIG. 2

Pin 15 is an active-high Chip Enable (CE). We control that pin with a signal from the keyboard that lets the 2579 know when a valid keypress has been made. If you examine the keyboard circuit in the last installment, you'll see there's a built-in "key-pressed" line—the common leg of the switches—that's tailor-made for this application.

In the keyboard circuit, the 4514

TABLE 1-2579 OUTPUTS

C1	C2	D3	D2	D1	D0	OUTPUT FREQUENCIES (Hz)		KEYPAD EQUIVALENT
						LOW GROUP	HIGH GROUP	
/	/	0	0	0	/	697	1209	/
/	/	0	0	/	0	697	1336	2
/	/	0	0	/	/	697	1447	3
/	/	0	/	0	0	770	1209	4
/	/	0	/	0	/	770	1336	5
/	/	0	/	/	0	770	1447	6
/	/	0	/	/	/	852	1209	7
/	/	/	0	0	0	852	1336	8
/	/	/	0	0	/	852	1477	9
/	/	/	0	/	0	941	1336	φ
/	/	/	0	/	/	941	1209	*
/	/	/	/	0	0	941	1477	#
/	/	/	/	0	/	697	1633	A
/	/	/	/	/	0	770	1633	B
/	/	/	/	/	/	852	1633	C
/	/	0	0	0	0	941	1633	D
0	/	Valid data				High group only		Single tone
/	0	Valid data				Low group only		Single tone

generates a high when a key is pressed. We used an inverter to flip the signal to control some pins of the 4514 and the 4520. The uninverted signal is exactly what we need for controlling the CE input of the 2579.

The overall sequence of operation is this: When a key is pressed, four bits of data are placed on the data bus. Next the "key-pressed" line goes high, the keyboard is frozen (debounced), and the 2579 is enabled.

The 2579 has an active-low MUTE output designed to let additional circuitry know that the 2579 is producing a tone. When valid data is present on the input bus, MUTE goes low. That signal is usually used to turn off the speaker and the microphone when the IC is used as the guts of a telephone. We don't intend to use the MUTE output, but keep it in mind—it may come in handy.

Another feature of the 2579 that you may find useful is available when you're using the IC in the binary (non-keyboard) mode. In that mode, the binary inputs are fed to the row inputs and the column inputs are ignored. However, two of the column inputs, C1 and C2 (at pins three and four), can still come in handy. When valid data is presented to the row inputs and CE is high, bringing C1 low will cause the 2579 to produce only the high-

group frequency. If C2 is brought low, the 2579 will produce only the low-group frequency.

Signal conditioning

Now that we have a circuit that produces a DTMF-encoded signal by pressing a key, we have to condition the signal before sending it to the transmitter. In our case, all we really need is something to amplify the output.

There are two considerations we should keep in mind as we start designing that part of the circuit: power consumption and the final output. We're building a handheld encoder/transmitter that's going to run off a nine-volt battery, so we must be careful about the amount of power that the circuit uses. Because our final output is modulated infrared light, we can afford to keep the circuit nice and simple—and inexpensive.

An op-amp is perfect for our amplifier. Op-amps come in every imaginable flavor, don't use much power, are nice and stable, and best of all, are very forgiving. Since all we're looking for is a little bit of gain and buffering, we can use just about any op-amp.

To keep our circuit options open, and make sure that the transmitter is as flexible as possible, we'll use one quarter of an LM324 quad op-amp. You might ask why we use a quad package

COMB

Authorized Liquidator



Amazing Hearoid™ talks and serves you!

19" tall

Remote Control Unit (Batteries not incl.)

He Obeys Your Commands!

REMOTE CONTROLLED HEAROID™ ROBOT

Great Fun For Everyone!

Liquidation due to famous Japanese manufacturer discontinuing this model.

- Loads of fun as Hearoid™ delights the family by serving them, carrying objects in hand or on a removable tray.
- Amaze and impress friends as Hearoid™ serves them and guides them on a talk tour of home (built-in cassette recorder).
- Remote microphone lets you converse with guests through robot.
- Hearoid™ obeys 12 voice commands. Performs programmed routines up to 45 minutes long.
- Switch from voice-activated to push-button control on remote unit.
- Programmable digital alarm clock lets you schedule daily tasks at a set time.
- Rechargeable battery (included) runs up to 3 hours at a time. Recharger incl.
- Factory new, first quality product.

90-Day Limited Factory Warranty.

Mfr. List: ~~\$399.95~~ **\$149**

Liquidation Price . . . **\$149**
Item H-1890-7000-862 Ship, handling: \$8.00

Credit card customers can order by phone, 24 hours a day, 7 days a week.



Toll-Free: 1-800-328-0609

Sales outside the 48 contiguous states are subject to special conditions. Please call or write to inquire.

C.O.M.B. Direct Marketing Corp. Item H-1890
1405 Xenium Lane N/Minneapolis, MN 55441-4494

Send Hearoid™ Robot(s) Item H-1890-7000-862 at \$149 each plus \$8 each for ship, handling. (Minnesota residents add 6% sales tax. Sorry, no C.O.D. orders.)

My check or money order is enclosed. (No delays in processing orders paid by check.)

Charge: VISA MasterCard American Express®

Acct. No. _____ Exp. _____ / _____

PLEASE PRINT CLEARLY

Name _____

Address _____

City _____

State _____ ZIP _____

Phone (____) _____

Sign Here _____

COMB Direct Marketing Corp.

Authorized Liquidator
1405 Xenium Lane North
Minneapolis, Minnesota 55441-4494

SATELLITE TV

continued from page 6

here in the United States.

The reason scrambling came into being is greed: greed on the part of the producers of *Videocipher II*, and greed on the part of the cable programmers. Because both the descrambler and the monthly programming charges were priced too high, entrepreneurs who possess the ability to decode *Videocipher II* have been attracted to the marketplace.

Such a situation cannot endure long in its present form, of course. There is a lesson here that, hopefully, future generations of scrambler builders will consider carefully before bringing their creations to market. R-E

DRAWING BOARD

continued from page 83

when all we need is a single op-amp. The answer is that, if we decide to add audio (or other circuitry) to the transmitter, it may be convenient to have an extra op-amp on board. One nice thing about the LM324 is that it's a low-power device and it's perfectly happy working from a single-ended supply.

However, if we really wanted to cut down on silicon, we could make our amp by daisy-chaining some of the unused inverters from the keyboard circuit. If you're into minimalist circuit design, feel free to substitute parts. You can even get rid of the inverter and replace it with a transistor. When it comes to experimenting, just remember Grossblatt's Sixth Law: Breadboards aren't made of stone. (It would be difficult to insert components if they were.—Editor)

The complete transmitter is shown in Fig. 3. The output of the op-amp is coupled to a 2N2222, which has enough output capability to drive two LED's. The use of two LED's increases the amount of power used by the transmitter, but it also increases its range. However, since the LED's draw current only when a key is pressed, a nine-volt battery should last fairly long.

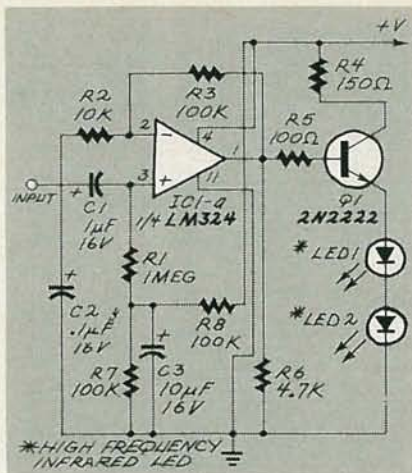

FIG. 3

You should use high efficiency LED's, which—wonder of wonders—you can find at Radio Shack. To increase range, you can use more than two LED's, but make sure that you don't allow more than about 40 ma of current flow through them, or you may burn them up.

Unless you're a mutant and can see infrared light, you won't be able to look at the LED's to see if the circuit is working. When you breadboard the circuit, substitute regular LED's for the infrared ones. If they flicker when you push a button, the circuit works. After you debug the circuit, replace the visible LED's with infrared ones.

Next month we'll start talking about the receiver and see what we have to do to build one. Remember that it's a bit more complex than the transmitter. R-E

OSCILLATORS

continued from page 70

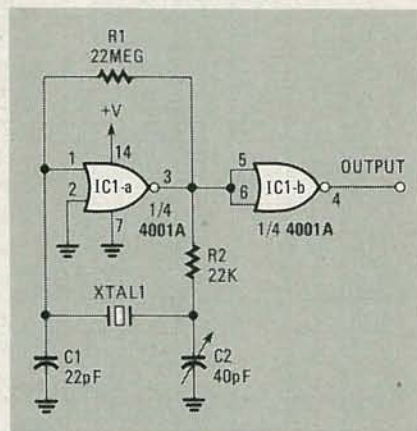

FIG. 7—A CRYSTAL OSCILLATOR can be built from a pair of CMOS gates.

frequency of oscillation is determined by R1 and C1, and to some extent by optional resistor R3. The value of R1 can be anything from 3000 ohms to 1 megohm, and the value of C1 can be anything from 100 pF to 10 µF.

Without R3, it is possible to build an oscillator that is variable over a range
continued on page 88

No previous experience necessary

LEARN PROGRAMMING



Master computers in your own home at your own pace in your spare time. Learn even before you decide on a computer.

BE YOUR OWN COMPUTER EXPERT

Programming is the best way to learn to use computers, and we can show you the best—and most economical—way to learn programming!

Send today for your free information package. No obligation. No salesman will call.

HALIX INSTITUTE
CENTER FOR COMPUTER EDUCATION DEPT. 49-1
1543 W. OLYMPIC, #226
LOS ANGELES, CA 90015-3894

YES! Send me free information on how I can learn about computers and programming at home!

Name _____

Address _____

City _____ State/Zip _____

You Can Be
One Of The
20,000 Technicians
Certified By ISCET



The International Society Of Certified Electronics Technicians offers permanent certification by administering the CET exam with the FCC recognized communications option for \$20. A second exam on FCC regulations for a \$10 fee is required for a Radiotelephone License. Upon passing, technicians receive both a permanent Radiotelephone Operator Certificate and a CET Certificate issued by ISCET.

ISCET Offers License Renewal

ISCET has developed a program for registration of those who currently hold a valid Radiotelephone Operator License. By sending a completed application, a photocopy of your FCC License, and \$10 your license will be renewed with the assurance of a recognized national technicians association behind it.

For More Information Contact:

ISCET 2708 W. Berry, Ft. Worth, TX
76109. (817) 921-9101

COMMUNICATIONS CORNER

Tunable IF



HERB FRIEDMAN
COMMUNICATIONS EDITOR

ONE BY-PRODUCT OF SOLID-STATE technology is the ability to provide moderate-cost communications equipment with high-performance circuits that were previously available only in "gold-plated" specials—very high-performance, very high-priced receiving equipment. The main reason it's possible is that a single IC can replace what was formerly an expensive and highly sophisticated tube or transistor circuit. Also, since an IC requires relatively little power, the receiver's power supply can remain simple—and, thereby, inexpensive.

One of the most desired of those by-products is the tunable IF amplifier, a device that makes it possible to eliminate—not just attenuate—interfering signals that are very close to the frequency of the desired signal.

Until the introduction of the tunable IF amp, heterodyne-type interference to CW and AM radio-telephone signals was usually attenuated by using a tunable notch filter, or by using a variable enhancer. A notch filter is generally used to null out the heterodyne tone, and an enhancer might be used to amplify a narrow range of frequencies, thereby lifting a signal (CW or voice) out of the background noise (QRM and QRN).

Variable bandwidth

Another, and usually more effective, form of interference rejection—particularly for radio-telephone signals—is variable selectivity, which allows the user to control the IF amplifier's bandwidth. That bandwidth (i. e., the receiver's selectivity) could be re-

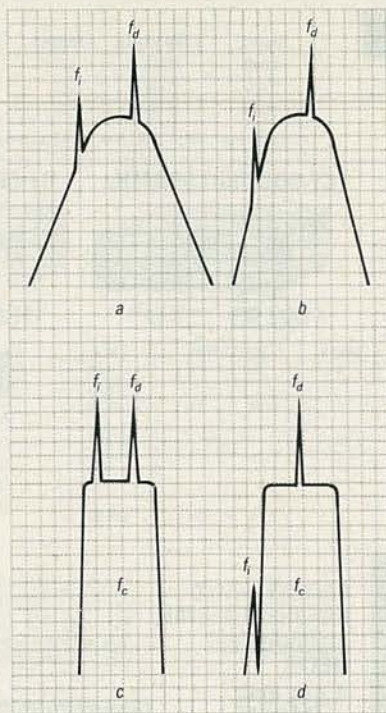

FIG. 1

duced until the interfering signal was positioned low down the selectivity curve, thereby effectively attenuating the interfering signal.

When selectivity is broad, as in Fig. 1-a, the interfering signal passes through the IF amplifier at the same level relative to the desired signal that it had at the antenna terminals. But when the IF bandwidth is narrow, as in Fig. 1-b, the interfering signal just might wind up low down the slope of the selectivity curve and thereby be attenuated. But, if the bandwidth cannot be made sufficiently narrow, the interfering signal will be unaffected.

An even better way to reduce or eliminate interference is to use a tunable IF amplifier, which accom-

plishes almost the same thing as IF bandwidth control, but with much greater efficiency. In fact, efficiency can be so high that it's often possible to drop an interfering signal "off the cliff." Combined with a narrow or variable-IF bandwidth, the tunable IF amplifier can for all practical purposes, make an interfering signal vanish.

A tunable IF amplifier is exactly what its name implies: an IF amplifier whose center frequency can be adjusted by the user while retaining the same selectivity (bandwidth). In a normal IF amplifier the tuning is peaked for a particular frequency—the IF or center frequency—and the selectivity on either side of the center frequency is more or less the same, although in reality there is usually an insignificant difference.

For example, if the IF frequency is 500 kHz and the bandwidth is 6 dB down at 505 kHz, it will also be 6 dB down at 495 kHz. The total bandwidth at -6 dB is, therefore, 10 kHz. A tunable IF amplifier might also have a 10-kHz bandwidth at -6dB, but because the tuning is user-adjustable, the center frequency itself might be moved to, say, 505 kHz, so that 495 kHz is now more than 80 dB down.

Figure 1-c shows both a desired and an interfering signal within the passband of a conventional center-tuned IF amplifier. However, in Fig. 1-d the base frequency of the IF amplifier has been shifted up, and, although the bandwidth remains the same, the interfering signal is now located well down on the selectivity slope. The interfering signal has effectively been eliminated. R-E

KENWOOD

...pacesetter in Amateur radio

NEW

Hear it All!



R-5000

High performance receiver

THE high performance receiver is here from the leader in communications technology—the Kenwood R-5000. This all-band, all mode receiver has superior interference reduction circuits, and has been designed with the highest performance standards in mind. Listen to foreign music, news, and commentary. Tune in local police, fire, aircraft, weather, and other public service channels with the VC-20 VHF converter. All this excitement and more is yours with a Kenwood R-5000 receiver!

- Covers 100 kHz-30 MHz in 30 bands, with additional coverage from 108-174 MHz (with VC-20 converter installed).
- Superior dynamic range. Exclusive Kenwood DynaMix™ system ensures an honest 102 dB dynamic range. (14 MHz, 500 Hz bandwidth, 50 kHz spacing.)



- 100 memory channels. Store mode, frequency, antenna selection.
- Voice synthesizer option.
- Computer control option.
- Extremely stable, dual digital VFOs. Accurate to ± 10 ppm over a wide temperature range.
- Kenwood's superb interference reduction. Optional filters further enhance selectivity. Dual noise blankers built-in.
- Direct keyboard frequency entry.

- Versatile programmable scanning, with center-stop tuning.
- Choice of either high or low impedance antenna connections.
- Kenwood non-volatile operating system. Lithium battery backs up memories; all functions remain intact even after lithium cell expires.
- Power supply built-in. Optional DCK-2 allows DC operation.
- Selectable AGC, RF attenuator, record and headphone jacks, dual 24-hour clocks with timer, muting terminals, 120/220/240 VAC operation.

Optional Accessories:

- VC-20 VHF converter for 108-174 MHz operation
- YK-88A-1 6 kHz AM filter
- YK-88S 2.4 kHz SSB filter
- YK-88SN 1.8 kHz narrow SSB filter
- YK-88C 500 Hz CW filter
- YK-88CN 270 Hz narrow filter
- DCK-2 DC power cable
- HS-5, HS-6, HS-7 headphones
- MB-430 mobile bracket
- SP-430 external speaker
- VS-1 voice synthesizer
- IF-232C/IC-10 computer interface.

More information on the R-5000 and R-2000 is available from Authorized Kenwood Dealers.

KENWOOD

TRIO-KENWOOD COMMUNICATIONS
111 West Walnut Street
Compton, California 90220

CIRCLE 102 ON FREE INFORMATION CARD

R-2000 150 kHz-30 MHz in 30 bands

- All modes
- Digital VFOs tune in 50 Hz, 500 Hz, or 5 kHz steps
- 10 memory channels
- Programmable scanning
- Dual 24-hour digital clocks, with timer
- 3 built-in IF filters (CW filter optional)
- All mode squelch, noise blanker, RF attenuator, AGC switch, S meter
- 100/120/220/240 VAC operation
- Record, phone jacks
- Muting terminals
- VC-10 optional VHF converter (118-174 MHz)



R-E Engineering Admart

Rates: Ads are 2 1/4" x 2 7/8". One insertion \$825. Six insertions \$800 each. Twelve insertions \$775 each. Closing date same as regular rate card. Send order with remittance to **Engineering Admart**, Radio Electronics Magazine, 500-B Bi-County Blvd., Farmingdale, NY 11735. Direct telephone inquiries to Arline Fishman, area code-516-293-3000. *Only 100% Engineering ads are accepted for this Admart.*

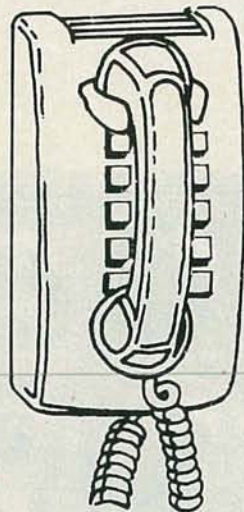

**CALL NOW
AND
RESERVE
YOUR SPACE**

- 6 x rate \$800.00 per each insertion.
- Reaches 239,312 readers.
- Fast reader service cycle.
- Short lead time for the placement of ads.

Call 516-293-3000 to reserve space. Ask for Arline Fishman. Limited number of pages available. Mail materials to: Engineering Admart, RADIO-ELECTRONICS, 500-B Bi-County Blvd., Farmingdale, NY 11735.

IBM-PC Schematic Design

A professional package enabling you to design, edit, print & plot electronic schematics. Supports "A" through "E" size sheets, over 2000 Unique Library Parts, Part Rotation, Unlimited Hierarchy, Grids, Auto Panning, 5 Zoom Levels, Rubberbanding, Powerful Macros, Hi-Res Color & Monochrome Graphics, Much More! \$495 Includes Everything.

Call or Write for Free Demo Disk.

OrCAD Systems Corporation
1049 S.W. Baseline St. Suite 500
Hillsboro, OR 97123
(503) 640-5007

8051, 8096, 68HC11, 68008 SINGLE BOARD COMPUTERS

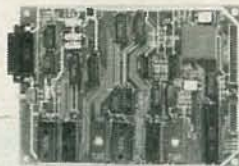

We feature a series of single board computers for process control applications. Available as bare boards or assembled and tested. Optional EPROM resident System. Monitors and BASIC interpreters are also available.

ALLEN SYSTEMS
2151 Fairfax Road
Columbus, Ohio 43221
614-488-7122

CIRCLE 183 ON FREE INFORMATION CARD

FREE	52 PAGE CATALOG AND APPLICATIONS GUIDE	CP/M MSDOS	AFFORDABLE ENGINEERING SOFTWARE	TRSDOS PCDOS
PDP — Plotter Driver Program for multi and single pen plotters	\$72.95	ACNAP — AC Network Analysis	\$72.95	
XFER — Transfer Function Synthesis transfer functions Electronic circuits	\$72.95	DCNAP — DC Network Analysis	\$72.95	
TEKCALC — Scientific Calculator Program Screen graphics Statistics Programmable	\$72.95	SPP — Signal Processing Program	\$72.95	
COMCALC — Communications Design Spreadsheet Communications budget calculator	\$72.95	PLOTPRO — Scientific Graph Plotting	\$72.95	
RIGHTWRITER — Report Proofreader Program Version 2 — Applies 2200 rules of English	\$97.95	PCPLOT — High Resolution Graphics	\$72.95	
		LOCIPRO — Root Locus Analysis	\$72.95	
		ACTFIL — Active Filter Design	\$72.95	
		STAP — static Thermal Analysis	\$72.95	
		MATRIC MAGIC — Matrix Manipulation	\$72.95	

BV Engineering
Professional Software (714) 781-0252
2200 Business Way, Suite 207, Riverside, CA 92501 USA

CIRCLE 194 ON FREE INFORMATION CARD

LINEAR IC EQUIVALENTS & PIN CONNECTIONS

Linear IC
Equivalents
and Pin
Connections



BP141—Shows equivalents & pin connections of a popular user-oriented selection of European, American and Japanese linear IC's 320 pages, 8 x 10 inches. **\$12.50 Plus \$2.75 shipping.** **ELECTRONIC TECHNOLOGY TODAY INC., PO Box 240, Massapequa Park, New York 11762-0240.**

OSCILLATORS

continued on page 70

spanning 1 MHz with a single control. You can vary operating frequency from DC to the frequency set by the R1/C1 combination (f_0). But with R3, you can vary the operating range; the variation depends on the value of R3 with respect to the value of R2. Without R3, as the control voltage (at pin 9) varies from 0 to +V, frequency varies from 0 to f_0 . But if R3 is used, and its value is 1/2 that of R2's, frequency varies from 0.5 f_0 to 1.5 f_0 . Other values can be obtained from manufacturers' data books.

CMOS crystal oscillator

Our final example is the crystal oscillator shown in Fig. 7. The circuit provides accurate and stable output. It uses two sections of a 4001 NOR gate, both of which function as inverters. One section of the 4001 (IC1-a) is the oscillator and the other section of that IC (IC1-b) is a buffer amplifier.

The oscillator circuit is a little unusual in that it's not strictly a digital oscillator, as are the other circuits in this installment. The reason is that IC1-a is biased into the linear region by R1, so it acts as an amplifier. (If you thought that a "digital" device can't function as a linear amplifier, you may be interested to know that gains

of 10,000 are possible with a buffered B-series device).

The operating frequency of that circuit is set by the crystal (XTAL1), which is operated in the parallel resonant mode. The RC components are selected to provide a 180° phase shift at the crystal's parallel resonant frequency.

Conclusion

In this series we have discussed many different kinds of oscillators, ranging from relaxation oscillators, to transistor-based RC and LC oscillators, to TTL and CMOS digital oscillators. We hope that the circuits presented will help you in your next design project.

R-E

SERVICE CLINIC

Leakage and psychology



JACK DARR,
SERVICE EDITOR

I'M NOT TALKING ABOUT THE KIND OF leakage in which you find a small puddle under the sink (or a young puppy), but a far more troublesome kind: electrical leakage in a circuit. It is a very common kind of trouble that can cause loss of sensitivity, audio distortion, and all kinds of gremlins.

Finding leakage isn't as hard as it sounds. Make continuity checks of all components connected to the B+ and AGC lines. Most B+ lines show a pretty high resistance, at least 50K or more. If you find a point with 25K or less, stop and check out all components—especially the capacitors.

Older sets are particularly susceptible to problems with leaky capacitors. Late-model sets show fewer troubles of that sort. (I guess that eventually they learned how to build capacitors that didn't leak!) Be that as it may, don't overlook the possibility in any TV set.

Dry electrolytic capacitors are a common cause of problems, especially the low-voltage (25-volts) types: they have built-in leakage! If you see one on an AGC line, or in any sensitive circuit, it's a prime suspect. Sometimes I even replace capacitors that appear to be good just on general principles.

To recognize a set with low B+, look for things like resistors overheating, low AGC, and low B+.

In fact, whenever you find a resistor that looks gray or has no visible color coding, look over the circuit for a leaky capacitor; you'll probably find one.

A handy tool for finding a leaky capacitor is the WCFT (the Well-Calibrated FingerTip). If a capacitor in the B+ is leaking, it will be

warm, and that's a sure sign of trouble. They don't get warm in AGC circuits, because of the lower voltages used there; you'll have to use an ohmmeter to pin down a leaky AGC capacitor.

A classic example of the kind of trouble a leaky capacitor can cause is as follows. I had a set with low B+ and other symptoms. At one point in the chassis there were four or five capacitors tied to a terminal strip. The leakage was greatest at that point. So I disconnected one of the capacitors, and checked for leakage. Still there. I disconnected another capacitor; still no help. Eventually I had disconnected all the capacitors and I still had leakage! Finally I realized that the terminal strip itself was leaking through a faulty ground connection!

So the general method to use when you find excessive leakage is to start disconnecting things until the leakage disappears. Sounds awfully simple, and it is. It's time consuming, but very practical!

Serviceman's psychology

Of course there are times when, no matter what you do, you just can't figure out what's wrong with a set. Then it's time to do something different. For example, I often make it a habit to curse in German—something like "himmel herr kreuss donnertter!" It sounds good, but it really only means something like "Heaven Mr. God Thunderweather!"

Then, when you've cleared the cobwebs out of your brain, you can get to work. The first step is to *think* about what's wrong and what might be causing it.

SEE YOUR DEALER TODAY

FROM

'Firestik'
ANTENNAS
ACCESSORIES

HERE'S A TIP
THAT'S PERFECT!

AM/FM AUTO RADIO
AND CB

'Firestik' II

GOLDEN SERIES

BARE-HANDS TUNABLE
"NO TOOLS NEEDED"
HIGH PERFORMANCE ANTENNAS

ALSO ANTENNAS FOR
CORDLESS TELEPHONES
MONITOR SCANNERS

Dealer & Distributor Inquiries Invited
SEND FOR FREE CATALOG

'Firestik' Antenna Company
2614 East Adams/Phoenix, AZ 85034

Name _____

Street _____

City _____

State _____ Zip _____

Serving the CB and
Communications Market Since 1962.

5-YEAR REPLACEMENT WARRANTY

CIRCLE 100 ON FREE INFORMATION CARD

Be an FCC LICENSED ELECTRONIC TECHNICIAN!



No costly school. No commuting to class. The Original Home-Study course prepares you for the "FCC Commercial Radiotelephone License". This valuable license is your "ticket" to thousands of exciting jobs in Communications, Radio-TV, Microwave, Computers, Radar, Avionics and more! You don't need a college degree to qualify, but you do need an FCC License.

No Need to Quit Your Job or Go To School
This proven course is easy, fast and low cost! **GUARANTEED PASS** - You get your FCC License or money refunded. **Send for FREE facts now. MAIL COUPON TODAY!**

COMMAND PRODUCTIONS

FCC LICENSE TRAINING, Dept. 90
P.O. Box 2223, San Francisco, CA 94126

Please rush **FREE** details immediately!

NAME _____

ADDRESS _____

CITY _____ STATE _____ ZIP _____

JANUARY 1987

SUPER LONG PLAY TAPE RECORDERS

10 Hour Model — \$95.00*
14 Hour Model — \$159.00*

Modified Panasonic Slimline, high quality, AC-DC Recorders provide 5 or 7 continuous hours of quality recording & playback on each side of cassette for a total of 10 or 14 hours depending on model. Built-in features include • Voice level control. • Digital counter, etc. TDK DC 180 Cassette Furnished.

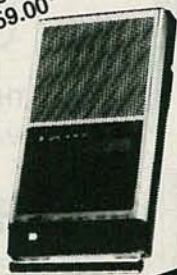

PHONE RECORDING ADAPTER

Records calls automatically. All Solid state, connects to your telephone jack and tape recorder. Starts recording when phone is lifted. Stops when you hang up. **\$24.50*** FCC APPROVED



VOX VOICE ACTIVATED CONTROL SWITCH

Solid state. Self contained. Adjustable sensitivity. Voices or other sounds automatically activate and control recorder. Uses either recorder or remote mike. **\$24.95***



*Add for ship & hdlg. Phone Adapter & Vox \$1.50 ea. Recorders \$4.00 ea. Cal. Res. add tax. Mail order, VISA, M/C, COD's OK. Money Back Guarantee. Qty. disc. avail... Dealer inquiries invited, Free data. © AMC SALES, Dept. A 9335 Lubec St., Box 928, Downey, CA (213) 90241 Phone 869-8519

CIRCLE 108 ON FREE INFORMATION CARD

ELECTRONIC COMPONENTS



176 PAGE

FREE CATALOG

Manufacturers of Quality Electronic Components

Serving the Nation from Texas and California

- BATTERY HOLDERS & CLIPS • COILS
- CAPACITORS • CONNECTORS • FUSES
- JACKS • KNOBS • LAMPS • PLUGS
- MICROPHONES • POTENTIOMETERS
- RELAYS • RESISTORS • SWITCHES
- TRANSFORMERS • SPEAKERS • LEDS
- SEMICONDUCTORS • RF COILS

OVER 16,000 DIFFERENT ITEMS IN STOCK!
CATALOGS MAILED OUTSIDE USA SEND \$2.00

MOUSER ELECTRONICS
2401 HWY 287 NORTH MANSFIELD, TX 76063
PHONE 817-483-4422

CIRCLE 117 ON FREE INFORMATION CARD

For example, it's common to receive a set for servicing that simply does nothing. An internal fuse may be blown, or a power transformer, etc. So you could make a continuity check of the primary power circuit. If you find an open fuse, you might try replacing it and then powering the set up gradually with a Variac while monitoring a series-connected AC ammeter. If current starts to rise quickly, power down, and look for a burned component in the power supply or B+ circuit.

A set with less drastic problems may require merely some signal tracing. Feed it a test signal and trace the signal from stage to stage using a scope. At any stage that functions as an amplifier the output should be larger than the input. Without trying to be too accurate, check oscillator stages for the (approximate) correct frequency of oscillation.

When you find a stage whose inputs or outputs are really strange, then you can start paying attention to the details. Measure DC bias voltages and see whether they agree with values on your service literature. If not, look for a resistor that has burned or drifted. Or a semiconductor device may have developed a short or an open. Measure nearby components with an ohmmeter. As we've said hundreds of times, most problems can be traced using very simple test equipment.

By adopting the habit of being systematic and logical, you should have fewer hard-to-diagnose problems. Your customers will appreciate it, because you'll charge them for less time, and the reduced anxiety will do you good psychologically!

R-E

SERVICE QUESTIONS

TUNER MEMORY TROUBLES

I've been working on a Sony KV1923 chassis that has a tuning memory. The problem is that once the set is turned on, it takes about 15-20 minutes for the memory to wake up and do its job. And even with the memory working, several of the lower channels have to be reset.

Will the entire memory board have to go, or is there a simpler solution?—R.R., Santa Barbara, CA

You have the kind of repair that lends itself so neatly to the hot and cold treatment. Apparently there are one or more components on the memory board that have to warm up before the unit can operate.

Try using a hair blower, soldering iron tip, or incandescent lamp to individually heat the components, and then check to see which ones respond. Once the suspects have been narrowed down, you can confirm your suspicions by reversing the procedure using a circuit coolant.

POWER-SUPPLY OVERLOAD

I have a dead Sears TV set, chassis number 564-4215. Unloaded, the power-supply reading is 150 volts; but when loaded, that value drops to about 50 volts. I tried unloading everything one at a time to see what's causing the problem, but that did no good. Please help!—A.H. Eureka, CA

I can only suggest that you try again, using the same technique, but this time take greater care. For the 120-volt line to be pulled down to 50 volts, there must be something placing an awfully heavy drain on it. To find the cause, it's necessary to separate the heaviest B+ users from the supply.

Start by disconnecting the vertical-output transistors, while checking to see if the voltage comes up. Next disconnect the horizontal output, and see what affect that has on the voltage. If that brings the B+ voltage up, check to see if the flyback is warm. If so you're on the right track.

FEEDBACK

I wrote to you about replacing a 0.8-amp fuse in my portable TV set that was blowing every week or so. You suggested that I try replacing it with a 1-amp unit, stating that the extra 0.2 amp would not compromise safety and that it might cause an intermittent component to break down completely, making the problem easier to locate.

Well, I tried it and the set has been working fine for the past couple of months. Perhaps, as you suggested, the fuse was under-rated from the beginning—G.S., Phila., PA R-E

ZENER PROBLEMS

I had an RCA CTC-59 that tripped the breaker seemingly at random. That set has solid-state horizontal outputs, and fast-switching diodes to produce the sweep and HV. After hooking the set to a Variac, I measured about 2.2—2.8 amps line-current drain, depending on picture content, brightness etc. In fact, the picture appeared to modulate the meter.

The horizontal oscillator in that set generates timed spikes of fixed amplitude to trip the SCR's that switch the current through the yoke and the flyback. The spikes varied in amplitude, and the breaker tripped.

Finally I found it. The power supply uses a 33-volt zener to regulate the voltage to the horizontal board, and it was intermittent! It caused intermittent variations in pulse height.—J. H. S., Columbia, SC.

Thank very much John for that handy hint. Always suspect Zener diodes until they have been checked and cleared! By the way, you gave us a perfect example of why analog meters still have a place in this world. You saw that "modulation," which, on a digital meter, would have appeared as a blur.

INTERMITTENT PULL-IN

A Zenith 23GC45 operates normally for days. Then the picture dims, pulls in from the left, and shows horizontal foldover, 8 inches wide, in the center of the screen. With the set on the bench, when the foldover occurred, the trace gets distorted, and loses its normal square-wave shape. I subbed a new 9-90 horizontal module; that didn't help.

Then I changed the output transistor; that didn't help either. After changing several other things, I finally got around to checking the components in the ground leg of the secondary of the driver transformer. I found that R224 measured 18 ohms; it should have been 1.5 ohms! Moving the resistor around made the reading jump between 18 and 1.5 ohms! So I removed it and found a hairline crack right around the middle. The bias was off because of that crack. Needless to say, I didn't charge the customer for all my "floundering time!"—B. M., Crofton, B. C., Canada.

Thanks Bill, for that interesting horror story. R-E

HUM PROBLEMS

I have an RCA KCS171XC. There's a low-pitched hum at all times; the volume control doesn't affect it. Also there is a moving hum bar in the video. If I bridge C1-a or C1-b with a 250- μ F capacitor, most of the video hum disappears, and the audio hum is also reduced. I replaced C1 and the 13V10 audio tube, which had a H-K short. I can't find anything else wrong, yet I get the same result as before. I also checked grounds and wiring to see if it had been changed.—J. R., Oneida, NY.

You've got a good start. Try examining the output of all filter capacitors with a scope to see if the ripple is higher than what is called for on the schematic, usually about 1.5 volt p-p. Two hum bars usually means 120-cycle hum, and one hum bar means 60-cycle hum. The 120-cycle hum is usually due to bad filter capacitors, and the 60-cycle hum to a H-K short, or leakage in one of the video tubes.

Trace the video circuit with a scope, and you should be able to see where the hum first shows up. Resoldering all ground connections is a good idea, especially all filter capacitors.

Cash in on the Video-Cassette Boom! START YOUR OWN TV/VCR REPAIR BUSINESS at Home in Spare Time



Now it's easy for you to get into this money-making business. Be the person in demand by the millions of families who own videocassette recorders—the fastest-growing product in the home entertainment field. Train at home in your spare time for an exciting career as a TV/VCR Repair Specialist. Experts show you how to start small at home with low overhead. Later you can go after repair business from hotels, offices, hospitals and other companies who use TVs and VCRs in their daily operations.

Experts show you what to do, how to do it...guide you every step of the way!

Learn how to handle house calls and shop repairs—everything you need to know to get started fast. Tools are included with your course so you get "hands-on" practice as you follow your lessons step by step. Everything is explained in easy-to-understand language, but if there is ever anything in your lessons you don't understand, you can write or phone your instructor and you can count on getting an authoritative answer. Get free facts and color brochure that tell about home business opportunities. No cost. No obligation. No salesman will visit.

MAIL COUPON TODAY!

ICS SCHOOL OF TV/VCR REPAIR, Dept. DEOC6
Scranton, Pennsylvania 18515

Please send me free facts on how I can learn TV/VCR Repair at home in my spare time.

Name _____ Age _____

Address _____

City/State/Zip _____

Phone () _____

SATELLITE TV The "Magic-Chip"



Special
\$250.
Plus Shipping

Available for the first time in the U.S.
FOR OAK SYSTEM DESCRAMBLERS

25 CHANNELS YOU CAN WATCH

MOVIES * SPORTS * NEWS * ENTERTAINMENT

- | | |
|-----------------------|-------------------------|
| • THE SPORTS NETWORK | • BCTV (CANADIAN IND) |
| • GLOBAL TV | • WJBK (CBS DETROIT) |
| • CHCH (CANADIAN IND) | • TELEBET |
| • WDIV (NBC DETROIT) | • HEALEAH RACING |
| • WXYZ (ABC DETROIT) | • WOLD RACING |
| • TVYT (CANADA IND) | • PENN. HOSPITAL ASSN. |
| • WORD OF FAITH | • PHILADELPHIA PARK |
| • BAY MEADOWS | • SANTA ANITA RACING |
| • NBC SPORTS | • SYNSAT |
| • MEADOWLANDS | • BTN |
| • HEALTH INFO | • TUCSON GREYHOUND PARK |
| • HOSPITAL CHANNEL | • MEADOWS RACING |
| • CITY (CANADIAN IND) | • YONKERS-ROOSEVELT |
| • WTVS (PBS) | • HOLLYWOOD PENN. NAT. |
- Doesn't Receive Ma/Com Scrambled Channels (HBO, CINEMAX).



HOW THE SYSTEM WORKS ?

The "MAGIC CHIP" easily fits into any Oak "P" descrambler box. Receive Canadian Channels that feature Movie, Sports, News and Variety programming. Also four Canadian Superstations, four U.S. Superstations and much more...

Watch Programs from SIX SATELLITES:

- | | |
|--------------|------------|
| • Westar 5 | • Galaxy 3 |
| • Spacenet 1 | • Anik D |
| • Satcom 4 | • Westar 4 |

EASY HOOK-UP



OAK SYSTEM SALES

RUSH ORDERS P.O. BOX 84208 ORDERS SENT
OK VANCOUVER, WASH. 98684 UPS COD

We expressly do not advocate the unauthorized reception of any transmitted signals. It is the purchaser's sole responsibility to pay all subscription fees.

CALL TODAY 1-206-253-4186 DEALERS WANTED

ATTENTION! ELECTRONICS TECHNICIANS

EARN YOUR
B.S.E.E.
DEGREE
THROUGH HOME STUDY



Our New and Highly Effective Advanced-Placement Program for experienced Electronic Technicians grants credit for previous Schooling and Professional Experience, and can greatly reduce the time required to complete Program and reach graduation. No residence schooling required for qualified Electronic Technicians. Through this Special Program you can pull all of the loose ends of your electronics background together and earn your B.S.E.E. Degree. Upgrade your status and pay to the Engineering Level. Advance Rapidly! Many finish in 12 months or less. Students and graduates in all 50 States and throughout the World. Established Over 40 Years! Write for free Descriptive Literature.

COOK'S INSTITUTE OF ELECTRONICS ENGINEERING

347 RAYMOND ROAD
P.O. BOX 20345
JACKSON, MISSISSIPPI 39209

MARKET CENTER

PLANS AND KITS

CATALOG: Hobby/broadcasting/1750 meters/ham/CB: transmitters, amplifiers, antennas, scramblers, bugging devices, more! **PANAXIS**, Box 130-F1, Paradise, CA 95969.

TEST LAB, make designing and testing prototype circuits easy. For a few dollars, turn your breadboards, into a valuable, easy to use, time saving lab. 15 different circuits. Send \$4.50 for plans or SASE for information. **TESTER**, P.O. Box 34, Newport, RI 02840

BUILD this five digit panel meter and square wave generator including an ohms, capacitance and frequency meter. Detailed instructions \$2.50. **BAGNALL ELECTRONICS**, 179 May, Fairfield, CT 06430.

CLASSIFIED AD ORDER FORM

To run your own classified ad, put one word on each of the lines below and send this form along with your check to:

Radio-Electronics Classified Ads, 500-B Bi-County Boulevard, Farmingdale, NY 11735

PLEASE INDICATE in which category of classified advertising you wish your ad to appear. For special headings, there is a surcharge of \$23.00.

() Plans/Kits () Business Opportunities () For Sale
() Education/Instruction () Wanted () Satellite Television

Special Category: \$23.00

PLEASE PRINT EACH WORD SEPARATELY, IN BLOCK LETTERS.

(No refunds or credits for typesetting errors can be made unless you clearly print or type your copy.) Rates indicated are for standard style classified ads only. See below for additional charges for special ads. **Minimum: 15 words.**

1	2	3	4	5
6	7	8	9	10
11	12	13	14	15 (\$42.75)
16 (\$45.60)	17 (\$48.45)	18 (\$51.30)	19 (\$54.15)	20 (\$57.00)
21 (\$59.85)	22 (\$62.70)	23 (\$65.55)	24 (\$68.40)	25 (\$71.25)
26 (\$74.10)	27 (\$76.95)	28 (\$79.80)	29 (\$82.65)	30 (\$85.50)
31 (\$88.35)	32 (\$91.10)	33 (\$94.05)	34 (\$96.90)	35 (\$99.75)

We accept MasterCard and Visa for payment of orders. If you wish to use your credit card to pay for your ad fill in the following additional information (Sorry, no telephone orders can be accepted.):

Card Number

Expiration Date

Please Print Name

Signature

IF YOU USE A BOX NUMBER YOU MUST INCLUDE YOUR PERMANENT ADDRESS AND PHONE NUMBER FOR OUR FILES. ADS SUBMITTED WITHOUT THIS INFORMATION WILL NOT BE ACCEPTED.

CLASSIFIED COMMERCIAL RATE: (for firms or individuals offering commercial products or services) \$2.85 per word prepaid (no charge for zip code)...**MINIMUM 15 WORDS.** 5% discount for same ad in 6 issues; 10% discount for same ad in 12 issues within one year; if prepaid. **NON-COMMERCIAL RATE:** (for individuals who want to buy or sell a personal item) \$2.30 per word, prepaid....no minimum. **ONLY FIRST WORD AND NAME** set in bold caps at no extra charge. Additional bold face (not available as all caps) **50¢ per word additional (20% premium).** Entire ad in boldface, add **20% premium** to total price. **TINT SCREEN BEHIND ENTIRE AD:** add 25% premium to total price. **TINT SCREEN BEHIND ENTIRE AD PLUS ALL BOLD FACE AD:** add 45% premium to total price. **EXPANDED TYPE AD:** \$4.30 per word prepaid. All other items same as for STANDARD COMMERCIAL RATE. **TINT SCREEN BEHIND ENTIRE EXPANDED TYPE AD:** add 25% premium to total price. **TINT SCREEN BEHIND ENTIRE EXPANDED TYPE AD PLUS ALL BOLD FACE AD:** add 45% premium to total price. **DISPLAY ADS:** 1" x 2 1/4"—\$320.00; 2" x 2 1/4"—\$640.00; 3" x 2 1/4"—\$960.00. **General Information:** Frequency rates and prepayment discounts are available. **ALL COPY SUBJECT TO PUBLISHERS APPROVAL. ADVERTISEMENTS USING P.O. BOX ADDRESS WILL NOT BE ACCEPTED UNTIL ADVERTISER SUPPLIES PUBLISHER WITH PERMANENT ADDRESS AND PHONE NUMBER.** Copy to be in our hands on the 12th of the third month preceding the date of the issue. (i.e., August issue copy must be received by May 12th). When normal closing date falls on Saturday, Sunday or Holiday, issue closes on preceding working day.

CABLE TV converters: Jerrold Products include "New Jerrold Tri-Mode," SB-3, Hamlin, Oak VN-12, M-35-B, Zenith, Magnavox, Scientific Atlanta, and more. (Quantity discounts) 60 day warranty. Service converters sold here. For fast service C.O.D. orders accepted. Send SASE (60 cents postage) or call for info (312) 637-4408. **Midwest Electronics, Inc./, HIGGINS ELECTRONICS**, 5143-R W. Diversey, Chicago, IL 60039. MC/Visa orders accepted. No Illinois orders accepted.

TELEPHONE bug, FM room bug schematics with detailed construction procedures using Radio Shack's numbered parts. Both, \$6.00. Receivers available. **SHEFFIELD ELECTRONICS**, 7223 Stony Island, Chicago, IL 60649.

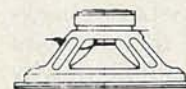

WRITE FOR

McGEE'S
SPEAKER & ELECTRONICS CATALOG

1001 BARGAINS IN SPEAKERS

toll free 1-800-346-2433 for ordering only.

1901 MCGEE STREET KANSAS CITY, MO. 64108

STATE-VARIABLE filter high pass low pass band pass; variable Q/variable gain; frequencies to 60KHz. Board and documentation only \$16.00. Board and essential parts \$25.00. Built and calibrated to your specifications send SASE. **GADGET ELECTRONICS**, P.O. Box 87705, Houston, TX 77287-7705.

VERIFY before you buy. Write for introductory list of authentic blueprints of master circuits and accessories. **CANPLAN (division FORTEBEC INC.)** 4690 Clark, Montreal, Quebec, Canada H2T2T4.

ELECTRONIC projects, components, PCB supplies, test instruments. Oscilloscopes \$219.00, multi-meters \$7.95, power supplies \$69.95. Resistors 1c. 2 year guarantee. Call or send SASE for free catalog. **T.O.R.C.C.C.**, 1131 Tower, Schaumburg, IL 60195. (312) 490-1374.

CABLE television converter, descrambler, and microwave television antenna equipment accessories video catalog. Free. **CABLE DISTRIBUTORS UNLIMITED**, 116-P Main Road, Washington, AR 71862.

FREE microprocessors, memory chips, etc. Free electronics magazine subscriptions. Free education in computers. For information write **MICROSAT CORPORATION**, 2401 N.E. Cornell, Bldg. 133, Hillsboro, OR 97124.

MOBILE telephone using your 2-way radio, plans \$9.95, with PC/brds \$24.95. **CURRENT DEVELOPMENT CORP**, Box 384, Westmoreland, NY 13490.

DESCRAMBLING, new secret manual. Build your own descramblers for cable and subscription TV. Instructions, schematics for SSAVI, gated sync, sinewave. (HBO, Cinemax, Showtime, etc.) \$8.95. For immediate delivery add \$1.00. **CABLE-TRONICS**, Box 30502R, Bethesda, MD 20814.

PAGING/CONTROLLER using your 2-way radio, plans \$6.95 with PC/brds \$16.95. **CURRENT DEVELOPMENT CORP**, Box 384, Westmoreland, NY 13490.



**SCIENTIFIC
ATLANTA
UNITS**

**LOWEST
PRICES
ANYWHERE!**



CABLE-TV



**WE'LL MATCH OR BEAT ANYONE'S
ADVERTISED RETAIL OR WHOLESALE PRICES!**

ITEM	SINGLE UNIT PRICE	DEALER 10-UNIT PRICE
RCA 36 CHANNEL CONVERTER (CH. 3 OUTPUT ONLY)	29.95	18.00 ea.
PIONEER WIRELESS CONVERTER (OUR BEST BUY)	88.95	72.00 ea.
LCC-58 WIRELESS CONVERTER	92.95	76.00 ea.
JERROLD 450 WIRELESS CONVERTER (CH. 3 OUTPUT ONLY)	105.95	90.00 ea.
SB ADD-ON UNIT	109.95	58.00 ea.
BRAND NEW — UNIT FOR SCIENTIFIC ATLANTA	<i>Call for specifics</i>	
MINICODE (N-12)	109.95	58.00 ea.
MINICODE (N-12) VARISYNC	119.95	62.00 ea.
MINICODE VARISYNC W/AUTO ON-OFF	179.95	115.00 ea.
M-35 B (CH. 3 OUTPUT ONLY)	139.95	70.00 ea.
M-35 B W/AUTO ON-OFF (CALL FOR AVAILABILITY)	199.95	125.00 ea.
MLD-1200-3 (CALL IF CH. 2 OUTPUT)	109.95	58.00 ea.
INTERFERENCE FILTERS — CH. 3	24.95	14.00 ea.
JERROLD 400 OR 450 REMOTE CONTROLLER	29.95	18.00 ea.
ZENITH SSAVI CABLE READY (DEALER PRICE BASED ON 5 UNITS)	225.00	185.00 ea.
SPECIFY CHANNEL 2 or 3 OUTPUT	Other products available — Please Call	

Quantity	Item	Output Channel	Price Each	TOTAL PRICE
			SUBTOTAL	
			Shipping Add \$3.00 per unit	
			COD & Credit Cards — Add 5%	
			TOTAL	

California Penal Code #593-D forbids us from shipping any cable descrambling unit to anyone residing in the state of California.
Prices subject to change without notice.

PLEASE PRINT

Name _____

Address _____ City _____

State _____ Zip _____ Phone Number (____) _____

Cashier's Check Money Order COD Visa Mastercard

Acct # _____ Exp. Date _____

Signature _____

FOR OUR RECORDS:

DECLARATION OF AUTHORIZED USE — I, the undersigned, do hereby declare under penalty of perjury that all products purchased, now and in the future, will only be used on cable TV systems with proper authorization from local officials or cable company officials in accordance with all applicable federal and state laws.

Dated: _____ Signed: _____

Pacific Cable Company, Inc.
 7325 1/2 RESEDA BLVD., DEPT. R-01 • RESEDA, CA 91335
 (818) 716-5914 • No Collect Calls • (818) 716-5140

IMPORTANT: WHEN CALLING FOR INFORMATION
 Please have the make and model # of the equipment used in your area. Thank You

JANUARY 1987

Saratoga Electronics

12380 SARATOGA-SUNNYVALE RD. SARATOGA, CA 95070



DYNAMIC RAMS

4164-150NS	\$.95
41256-150NS	2.65

PC/AT COMPATIBLE SYSTEM BOARD

\$549.00

640 KB/1.0 MB BIOS

PC/XT COMPUTER KIT

\$795.00

640KB Turbo (6 & 8 MHz) System Board
(2) Fujitsu 360 KB Floppy Drives w/ Controller
Mono Graphics w/ Printer Port
Monochrome Monitor
Case, 135 Watt Power Supply, Keyboard
Manuals & 90-Day Warranty On All Components

EPROMS

2716-450NS	\$2.95
2732A-450NS	2.25
2764-450NS	3.00
2764-250NS	3.75
27256-250	6.75

DRIVES

Teac 55B	\$ 85.00
Fujitsu M2551A	79.00
MIT 4853 Quad/DS 96 TPI	69.95
Seagate ST-225 20MB 1/2 Ht.	299.00
Quantum 40MB Full Ht.	595.00

CONTROLLERS

PC/XT Fixed Disk Controller	
NDC 5127-50	\$ 89.95
OMTI 5510	\$ 95.00
ADAPTEC ACB-2070A	\$149.95
RLL Controller	
PC/AT Fixed Floppy Disk Controller	
NDC 5125	\$189.95

EXTERNAL HARD DRIVE SUBSYSTEMS

SUBSYSTEMS FOR BOTH THE PC/XT, PC/AT AND COMPATIBLE COMPUTERS. EACH SUBSYSTEM ENCLOSURE INCLUDES:

Slim-line (1/2 ht.) or full ht. enclosures available	All internal cabling
40 watt switching power supply (115,230V)	IBM beige color type
EMI type filter w/external fuse	FCC approved
Full-shielded 50-pin interconnect cable	

PRICE (enclosure only)	\$ 195.95
20 MB SEAGATE ST-225 SUBSYSTEM	575.00
30 MB SEAGATE ST-4038 SUBSYSTEM	825.00
40 MB QUANTUM Q-540 SUBSYSTEM	795.00
50 MB SEAGATE ST-4051 SUBSYSTEM	995.00
70 MB VERTEX V-170 SUBSYSTEM	1099.00

90 DAY WARRANTY ON ALL SUBSYSTEMS

TANBERG 60 MB TAPE DRIVE BACKUP KIT

★ **\$595.00** ★

Includes Tanberg Tape Drive, T4044 Controller, Software and Cables, 3M Tape Cartridge and Warranty

★ HARD DISK DRIVE ★

\$795.00

PC/AT COMPATIBLE

Vertex V-170 60 MB Formatted 30 msec Access Time

SPEEDSTOR VERSION 4.0

\$89.95

Hard Disk Drive Integration & Diagnostic Utility for PC, PC/XT & PC/AT



408/446-4949
TOLL FREE

VISA

800/621-0854 ext. 245

PRICES SUBJECT TO CHANGE • \$25 MINIMUM ORDER

CIRCLE 97 ON FREE INFORMATION CARD

THIS SPACE CONTRIBUTED AS A PUBLIC SERVICE

A defense against cancer can be cooked up in your kitchen.

There is evidence that diet and cancer are related. Follow these modifications in your daily diet to reduce chances of getting cancer.

1. Eat more high-fiber foods such as fruits and vegetables and whole grain cereals.
2. Include dark green and deep yellow foods and vegetables rich in vitamins A and C.
3. Include cabbage, broccoli, brussels sprouts, kohlrabi and cauliflower.
4. Be moderate in consumption of salt-cured, smoked, and nitrite-cured foods.
5. Cut down on total fat intake from animal sources and fats and oils.
6. Avoid obesity.
7. Be moderate in consumption of alcoholic beverages.

No one faces cancer alone.

AMERICAN CANCER SOCIETY

CHANNEL 3—60db notch filter, 63.5MHz. \$19.95. All other channels \$29.95. Cable converter and accessory catalog \$1. (514) 739-9328. **CROSLLEY(A)**, Box 840, Champlain, NY 12919.

CABLE television converter, descrambler, and microwave television antenna equipment accessories video catalog. Free. **CABLE DISTRIBUTORS UNLIMITED**, 116 Main Road, Washington, AR 71862.

CABLE Dealers—Get your free catalog for the best buys on quality cable equipment. Most prices too low to print. N-12 Mini Code \$100.00. S.B. 2 or 3 \$99.00. Trimodes are the special of the month \$100.00. Hamlin Mid 1200 \$89.00. Extra remotes, cable converters, Pioneer, Jerrold, Viewstar, Starcom, Video Switcher. All products guaranteed 90 days. We accept M.C., VISA, COD's. Call or write for your free catalog today. (402) 331-4957. **M.D. ELECTRONICS**, 5078 South 108th, Suite 115, Omaha, NE 68137.

Multi-Channel Microwave T.V. Receivers

1.9-2.7 GHz Parabolic Dish 40+ dB Gain
LIFETIME WARRANTY

Complete System \$89.95 (Shipping Incl.)
Dealer Rates, Replacement Components & Expert Repairs Available

K & S ELECTRONICS Call now for same day shipping!
P.O. BOX 34522 PHOENIX, AZ 85067 (602) 230-0640

VISA/MC/COD \$2 credit on phone orders!

COMPUROBOT-A programmable robot, up to 48 different programming commands. Not a kit complete self-contained unit. Price, \$43.00 information \$1.00. **WENDEL L. DANIELS ENGINEERING CONSULTANT**, 8450 Anthony Wayne Ave., Cincinnati, OH 45216.

SCIENTIFIC Atlanta non-addressable converters—8500 series Original units, remote control...\$250.00—\$275.00. **Tocom** and **Zenith** descramblers available, guaranteed. N.A.S., (213) 631-3552.

CB'ERS—monitor your CB'S modulation thru headphones, "Audio Tracker"...\$19.95, details—\$1.00. **LEK-TRONIX**, Box 5261, Long Beach, CA. 90805. (213) 631-3552.

CABLE-TV converters and descramblers. Low prices, quality merchandise, we ship C.O.D. Send \$2.00 for catalog. **CABLETRONICS UNLIMITED**, P.O. Box 266, South Weymouth, MA 02190. (617) 843-5191.

Pay TV and Satellite Descrambling All New 6th Edition!

100 pages. The most complete source of descrambling information available. Theory and schematics for the most popular cable and satellite systems. Pilotless, trimode, bypasses, detection of illegal descramblers, 7 satellite systems, current news, etc. **\$14.95 CABLE TV. NEW!** Two-way transmission, bidirectional filters, etc. How the systems work. **\$12.95. MDS/ MMDS HANDBOOK.** Theory, schematics for 1.9-2.7 GHz, terrestrial microwave. New edition. **\$11.95. SATELLITE SYSTEMS UNDER \$600.** \$11.95. Outband PC's with coils \$14. Any 3 books \$26. New winter 87 product and kit catalog \$1.

Shojiki Electronics Corp., 1327R Niagara St., Niagara Falls, NY 14303. COD's 716-284-2163

SATELLITE TV

CABLE TV Secrets—the outlaw publication the cable companies tried to ban. HBO, Movie Channel, Showtime, descramblers, converters, etc. Suppliers list included \$8.95. **CABLE FACTS**, Box 711-R, Pataskala, OH 43062.

SATELLITE systems \$349.00, catalog \$2.00. Also: KU band, exports. **STARLINK, INC.**, 2603-16R Arlie, Huntsville, AL 35805.

OAK Orion "Turn-On" modifications: "Chip kit" or "Remote keypad." details—\$1.00. **NAS-SAT**, Box 5261, Long Beach, CA 90805. (213) 631-3552.



One tree can make 3,000,000 matches.



One match can burn 3,000,000 trees.



A Public Service of The Magazine of The Advertising Council

TRANS-AM

ELECTRONICS

383 CANAL ST NYC, NY 10013
(212) 226-3893

VISIT OUR RETAIL STORE

BATTERY HOLDER W/ BELT CLIP 1.95

2 'D' cell battery holder with a belt clip like the walkman external power pack. Comes with 1/8" mini plug.

SOLID STATE BEEPER 2.95

A 12 vdc beeping tone that can be used as a back-up indicator for a car or any other similar application. Mounting holes are 2" apart.

FLASHING BINKY 1.19

Self contained batteries operate this colorful amulet that starts flashing randomly when you touch it and goes off by itself. Specify pink or blue.

PROJECT BOX 3.95

A 4" x 6" x 3" metal box with 4 rca jacks on one end and rubber feet. Comes apart with screws. Very well made.

WALL TRANSFORMERS

All plug directly into 120 vac outlet.

9 vdc @ 200 ma\$1.95
12 vdc @ 300 ma\$2.95
14 vdc @ 500 ma\$3.95

TERMS: \$10 MINIMUM ORDER. ADD \$2.50 FOR UPS AND HANDLING. NYS RESIDENTS ADD 8.25% TAX. SEND ORDER WITH CHECK OR PHONE IN ORDER BETWEEN 11am AND 5pm EST. ALL ITEMS SUBJECT TO PRIOR SALE.

CIRCLE 196 ON FREE INFORMATION CARD

COMPUTER CLOSE-OUT SPECIALS



PANASONIC PERSONAL COMPUTER Model# JR-200 U

All working—Original dealer cost.\$249.99
Close-out special ONLY\$ 69.99

PANASONIC ACOUSTIC MODEM Model# JR-P10 U 300 BAUD RS-232-C

Close-out special\$39.99
With purchase of computer.....\$24.99

PANASONIC GRAPHIC PRINTER Model# JR-PO2 U

Dot Matrix—80 Characters Per Line
Centronics Type Parallel Interface
Close-out special\$174.00
With purchase of computer.....\$ 99.99

COMPLETE PACKAGE—Computer, Modem,
Printer, and Cables ONLY\$190.00

ALL SALES FINAL
NOT GUARANTEED BY PANASONIC

Mail order only,
Checks, Money Orders, C.O.D.

NIVIE ELECTRONICS, INC.
970 Kent Avenue 5th Floor
Brooklyn, N.Y. 11205
Telephone# 1-(718)-230-9861

CIRCLE 201 ON FREE INFORMATION CARD

SATALLITE TV descramblers. Cable TV descramblers. Assembled units and kits. Several models. Hard to find items. Schematics, circuit boards, parts. Catalog \$5.00. SCIENTIFIC SUPPLY, P.O. Box 1881, Murfreesboro, TN 37133.

SCRAMBLIN', News-Newsletter: 6 months trial subscription \$9.00. Send check along with your name and address to: SNN, P.O. Box 85, Millidgeville, GA 31060.

SATELLITE descrambling manual. Thorough explanation of digital audio encoding. (HBO, Cinemax, Showtime, etc.) \$10.95. For immediate delivery add \$1.00. CABLETRONICS, Box 30502R, Bethesda, MD 20814.



Quality Microwave TV Antennas

Multi-Channel 1.9 to 2.7 GHz
40 dB Gain True Parabolic 20 inch Dish
U.L. Listed Power Tuner
Comp. System: \$99.95 (Shipp. not incl.)
DREAM CHASER SYSTEMS

P.O. Box 8014 • Blaine, WA. 98230
604-590-3367 (\$3 credit-phone orders)
MasterCard Visa COD's Qty. Pricing

DESCRAMBLER unscramble videocipher II satellite TV signals with Decipher-Two (video only). Simple low cost circuit using only three timer IC's. P.C. board, instructions \$35.00. P.P. VALLEY MICRO-WAVE ELECTRONICS, Bear River, Nova Scotia, Canada BOS-1B0. (902) 467-3577.

SATELLITE TV receiver kits, LNA's, instructions, schematics. Send stamped envelope: XANDI, Box 25647, Dept. 21J, Tempe, AZ 85282.

TUNE subcarriers on FM receiver. Including multiplex stereo. Plans \$8.65, components \$14.60, board \$9.50. I.F. IN-NOVATIVE, Box 745, Madras, OR 97741.

BUSINESS OPPORTUNITIES

MECHANICALLY inclined individuals desiring ownership of small electronics manufacturing business—without investment. Write: BUSINESSES, 92-R, Brighton 11th, Brooklyn, NY 11235.

YOUR own radio station! AM, FM, TV, Cable. Licensed/unlicensed. BROADCASTING, Box 130-F1, Paradise, CA 95969.

EARN \$100 per hour conducting countermeasure sweeps using our low cost de-bugging equipment. Catalog \$2. SSE, P.O.Box 15104, Cleveland, OH 44115.

PROJECTION TV...Make \$\$\$'s assembling projectors...easy...results comparable to \$2,500 projectors. Total cost less than \$30.00 PLANS, 8" LENS and dealers information \$20.50. Illustrated information free. MACROCOMA-GEX, Washington Crossing, PA 18977. Creditcard orders 24hrs. (215) 736-2880.

BURGLAR alarms-booming business. Get started now. INFORMATION \$2.00. DYNAMIC SECURITY, P.O.B.1456-TW, Grand Rapids, MI 49501.

PERSONAL computer owners can earn \$1000 to \$5000 monthly offering simple services part time. Free list of 100 services. Write: C.I.L.G.B., P.O. Box 60369, San Diego, CA 92106-8369.

EDUCATION & INSTRUCTION

FCC commercial general radiotelephone license correspondence course. 60 individual lessons for \$89.50. Payment plan. Results guaranteed! Details free. AMERICAN TECHNICAL INSTITUTE, Box 201, Cedar Mountain, NC 28718.

LEARN MORSE CODE IN 1 HOUR. Amazing new easy technique. Money back guarantee. \$5. BAHR, 2549E Temple, Palmbay, FL 32905.

AMATEUR radio code practice for IBM PC. Send \$19.95 check to SP MICRO, 1008 Swallow Drive, Cherry Hill, NJ 08003.

THIS IS A REGULAR CLASSIFIED AD WITH A TINT BACKGROUND. To have your ad appear like this one, there is a 25% premium.

PRINTED-CIRCUIT BOARDS

LOW quotes, high quality, quick service. Single, double sided, multilayered boards. Prototypes through production quantities. Design/layout capabilities. Board assembly/turnkey facilities. Call or write for quotes and info.—T.O.R.C.C.C., 1131 Tower, Schaumburg, IL 60195. (312) 490-1374.

CIRCUIT boards, double and single sided with plated through holes. Cad/cam artwork design. SmArtwork and EE/designer supported. Competitive pricing. EXPRESS CIRCUITS, 314 Cothren Street, P.O. Box 58, Wilkesboro, NC 28697. (919) 667-2100.

INVENTORS

INVENTORS! Can you patent and profit from your idea? Call AMERICAN INVENTORS CORPORATION for free information. Over a decade of service. 1 (800) 338-5656. In Massachusetts or Canada call (413) 568-3753.

LASERS

HE-NE complete \$129.95, modulated systems available LES ELECTRONICS, PO Box 800276, Dallas, TX 75380.

CABLE-TV

DEALERS wanted: channel 2, 3, and 4 notch filters. Money back guarantee. Send \$15.00 for sample and quantity price list. Specify channel(s). GARY KURTZ, Box 291394, Davie, FL 33329.

COCO II UPGRADES (PARTS)

COCO II upgrade kits, RGB interface, 256K memory, etc. ELECTRONIC PARTS all types—free catalog. INVENTIVE SOLUTIONS, P.O. Box 286, Stanfordville, NY 12506.

CABLE-TV DESCRAMBLING

CABLE television converter, descrambler, and microwave television antenna equipment accessories video catalog. Free. CABLE DISTRIBUTORS UNLIMITED, 116-C, Main Road, Washington, AR 71862.

EPROM PROGRAMMING

FREE catalog. Your software/data installed in (E)PROM of your choice. Fast, low cost service. Write/call: ROMULUS MICROCONTROL, Dept. A, Box 8669, Rockville, MD 20856. (301) 540-8863.

MASTERCARD AND VISA are now accepted for payment of your advertising. Simply complete the form on the first page of the Market Center and we will bill.

WANTED

INVENTORS! AIM wants—ideas, inventions, new products, improvements on existing products. We present ideas to manufacturers. Confidentiality guaranteed. Call toll free 1 (800) 225-5800 for information kit.

INVENTIONS. ideas, new products wanted! Industry presentation/national exposition. Call free 1 (800) 528-6050. Canada, 1 (800) 528-6060. X831.

DO IT YOURSELF TV REPAIR

NEW...repair any TV...easy. Retired serviceman reveals secrets. Write, RESEARCH, Rt.3, Box 601BR, Colville, WA 99114.

Radio Shack Parts Place™

START YOUR NEW YEAR'S PROJECT AT RADIO SHACK

Lights, Sound, Action! At Everyday Low Prices

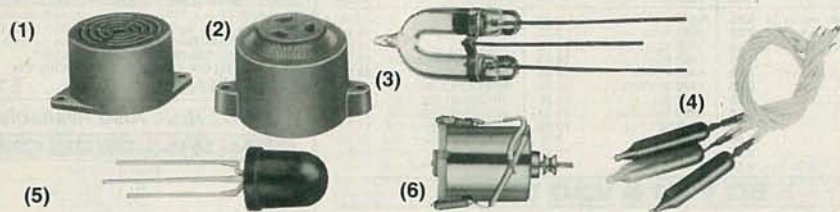

(1) **Tri-Sound Siren.** IC, driver and 8-ohm speaker in a compact 1 1/4 x 1 9/16" case. Wiring options let you create three unique, extra-loud sounds. Requires 3 VDC. #273-072 5.95
 (2) **Two-Tone Piezo Buzzer.** Produces 100 dB at 2500 Hz. Great for vehicle backup alert. Attenuator vanes. 8-16 VDC. #273-070 8.95
 (3) **Zenon Flash Tube.** High-output design, rated at 100,000-flash life. #272-1145 2.99

(4) **12-Volt Flashing Lamps.** Great for hobby projects and model trains. One each: yellow, red, green. 95 mA. #272-1097 Pkg of 3/99c
 (5) **Jumbo Red LED.** Two LED elements in one 10 mm diameter housing. Really big and bright! #276-065 1.19
 (6) **Hobby Motors With Brass Pulley.** With noise suppressor. 3 1/2 to 9 VDC. Approx. 2" by 1 1/8" dia. #273-229 Pkg. of 2/1.49

Our IC/Semi "Hotline"



Speedy Service From Our Warehouse

Radio Shack can replace almost any IC or semiconductor! If the device is not part of our regular stock, we'll special-order it. Delivery time for most items is one week, and there's no shipping charge or minimum order requirement. Radio Shack also offers this convenient service on selected crystals, tubes, phono cartridges, and more.

Voice Synthesizer Team

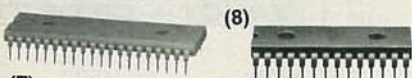

Give Your Computer a Voice

(7) **CTS256-AL2 Text-to-Speech IC.** Translates ASCII characters into control data for synthesizer below. Connects to RS-232 port. With detailed data and schematics. 40-pin. #276-1786 16.95
 (8) **SPO256-AL2 Voice Synthesizer.** Easy to interface with most computers. Includes data and circuit examples. 28-pin. #276-1784 12.95

Project Enclosures

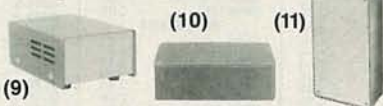

(9) **Metal Cabinet.** Vented steel top, easy-to-work chassis. Includes protective rubber feet and assembly hardware. 5 1/4 x 3 x 5 7/8". #270-253 4.99
 (10) **Blue Economy Case.** With internal slots for PC board. 7 1/2 x 4 1/8 x 2 1/8". #270-224 2.99
 (11) **Experimenter Box.** Plastic body with aluminum cover. 7 3/4 x 4 3/8 x 2 3/8". #270-232 2.99

Many other styles and sizes available!

Circuit Design Programs

Use Your Computer To Select Proper Component Values!

4⁹⁵



This 132-page book contains listings for BASIC programs that help you design electronic circuits. Topics include: R-C, R-C-L and filter circuits, transistor circuits and timer circuits using the popular 555 IC. #62-1054

Computer Parts Bargains



(12) **Keyboard.** Originally for famous "99/4" computer. High-quality QWERTY board has 48 keys, 15-pin connector. With schematic. #277-1023 3.95
 (13) **DC Supply.** High-quality switching type supply, originally for "99/4". Great for powering digital and experimenter circuits. Produces +12 VDC at 400 mA, +5 VDC at 1.1 amp and -5 VDC at 200 mA. Input: 18-25 VAC. #277-1016 4.95

RS-232 Driver & Receiver

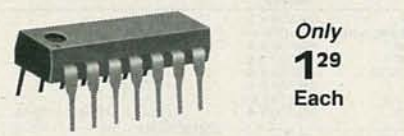

Only 1.29 Each

MC1488 RS232 Quad Line Driver. Lets you hook up terminals and remote peripherals with simple "twisted pair". Also matches up different logic families. 14-pin DIP with complete data. #276-2520 1.29
MC1489 RS232 Quad Line Receiver. Use with above. 14-pin DIP with data. #276-2521, 1.29

Switch-O-Rama!



(14) **Lighted SPST.** N.O. or N.C. Rated 5 amps at 250 VAC. Lamp requires 12 volts AC or DC. Mounts in 5/8" diameter hole. #275-678 5.95
 (15) **SPST Push-On/Off.** Rated 3 amps at 250 VAC. Mounts in 1/2" hole. #275-617 1.59
Momentary Version. N.O. #275-618 1.49
 (16) **SPDT Submini Toggle.** With center-off position. 10 amps at 125 VAC. #275-325 2.29

Bench Digital Multimeter

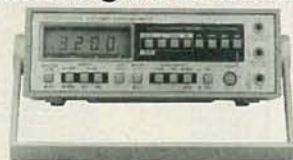

Our Finest Ever With Probes, Manual 99⁹⁵

Compares with meters costing several times more! Offers convenient all-pushbutton operation with full autoranging, manual override and memory storage of high and low values. Has built-in 31-position bargraph display in addition to high-contrast LCD digital readout. Measures AC/DC volts, AC/DC current, resistance, and transistor h_{FE}. Also has continuity-check and diode junction-test modes. Detented handle doubles as a stand. Fused and overload protected. #22-195 . . . 99.95

Wire-Wrapping Supplies

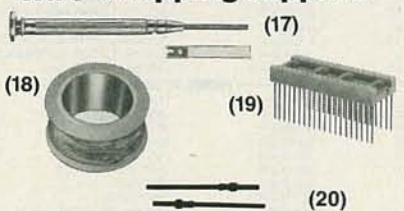

(17) **Wrapping Tool.** #276-1570 5.95
 (18) **30-Gauge Wire.** (19) **Wrapping Sockets.**

Color	Cat. No.	50-ft. Spool	Pins	Cat. No.	Pkg. of 2
Red	278-501	2.39	8	276-1988	1.19
White	278-502	2.39	14	276-1993	1.29
Blue	278-503	2.39	16	276-1994	1.39
Yellow	278-504	2.39	28	276-1983	1.39
			40	276-1984	1.99

(20) **Wrapping Posts.** #276-1987 Pkg. of 20/69c

Computer Connectors

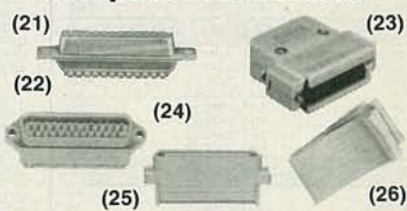

Fig.	Type	Positions	Cat. No.	Only
21	D-Sub Male	25	276-1547	1.99
22	D-Sub Female	25	276-1548	2.99
23	Shielded Hood	25	276-1536	1.99
24	D-Sub Male IDC	25	276-1559	3.99
	D-Sub Female IDC	25	276-1565	3.99
25	Male Printer IDC	36	276-1533	5.99
	Female Printer IDC	36	276-1523	5.99

(26) **RS232 Ribbon Cable.**
 25-Cond. 5 ft., #278-772, 3.59 36-Cond. 6 ft., #278-774, 4.69

Over 1000 items in stock: Binding posts, Books, Breadboards, Buzzers, Capacitors, Chokes, Clips, Coax, Connectors, Fuses, Hardware, ICs, Jacks, Knobs, Lamps, Multimeters, PC Boards, Plugs, Rectifiers, Relays, Resistors, Switches, Tools, Transformers, Transistors, Wire, Zeners, more!

Radio Shack®
 A DIVISION OF TANDY CORPORATION

Prices apply at participating Radio Shack stores and dealers

CIRCLE 78 ON FREE INFORMATION CARD

JANUARY 1987

cable tv

DESCRAMBLER PARTS!

We stock the exact parts, PC board and AC adaptor for Radio Electronics February 1984 article on building your own **Cable TV Descrambler**.

#701 PARTS PACKAGE.....\$29.95
Includes all the original resistors, capacitors, diodes, transistors, integrated circuits, coils, IF transformers (toko BKAN-K5552AXX).

#702 PC BOARD.....\$12.95
Original etched & drilled silk-screened PC board used in the article.

#704 AC ADAPTOR.....\$12.95
Original (14 volts DC @ 285ma) ac adaptor used in the article.

S P E C I A L S

BOTH #701 & #702..... NOW \$39

ALL THREE #701, #702 & #704 NOW \$49

Add \$2.50 shipping and handling — \$4.50 for Canadian orders
We also offer quantity Discounts on 5 or more units

FREE Reprint of Radio Electronics article (February 1984) on Building Your Own **CABLE TV DESCRAMBLER** with any purchase of above.

**60-CHANNEL
CABLE
CONVERTER**
WITH INFRARED REMOTE CONTROL



SC-60R CONVERTER.....\$69.95

Thousands of these converters sold nationally for \$119.95
We offer you this same type of converter for only \$69.95
All converters are NEW, with Full manufacturer's WARRANTY.

FEATURES:

- Full 60 Channel Capability
- Cordless Infrared remote control
- Ultra-Stable Synthesized tuning
- Microprocessor controlled PLL
- Works on all TV models, channel 3 output
- Standard/HRC Switch for compatibility with all Cable Systems
- Will work with all types of external descramblers

Add \$3.50 Shipping and Handling
\$4.50 on Canadian Orders

**ORDER
TOLL FREE
1-800-227-8529**

inside MA 617-695-8699
VISA, MASTERCARD or C.O.D.



**J & W
ELECTRONICS, INC.**

P.O. BOX 800R • MANSFIELD, MA 02048

#1 FOR KITS IN THE USA

DICK SMITH ELECTRONICS

FEATURED IN: Radio-Electronics Nov-Dec 1986



Get closed - captioned TV!
Cat K-6314

Using decoding technology licensed from NCI, the SuperText TC provides two separate captioning channels and two full-screen text services (including program listings for captioned broadcasts). It connects to the audio/video outputs of newer TV's, VCR's or component TV tuners (an RF modulator for direct antenna connection is optional). No special tools are required to build this kit - just basic bench tools, good soldering technique, and a multimeter. The kit includes a handsome camel brown case, punched & screened front and rear panels, all parts (even solder) and complete instructions. Power supply not included.

Features: Direct audio & video inputs & outputs • Single all-function control • External contrast adjustment • Compact size • No dangerous internal voltages.



PLAYMASTER Stereo Amp Kit
Cat K-3516

More power to the stereo!

Feature for feature, dollar for dollar, this kit outperforms the big name competition! Electronic input circuitry handles moving magnet, moving coil, CD, hi-fi, NCR, cassette, tuner & more. Sort touch controls, de-thump, toroidal transformers and much more! Step-by-step instructions make it easy to build (but if, after examination, you decide it's beyond your abilities, just return the kit intact for a full refund).

• 100W RMS/channel into 8 ohms • Hum: 100dB below full output • Freq. response: 8Hz-20KHz (-3dB), 2.8Hz-85KHz (-1dB) • Unconditional stability in any load • Distortion 0.01% (typ) 0.03% 20Hz-20KHz • Sensitivity: MN 2-mV (80dB S/N) MC 200uV (75dB) CD 2V (94dB)



Geiger Counter

Detects alpha, beta, gamma, x-rays & more!
Switching range 0.5R/hr. - 50mR/hr.

\$199
Cat Q-1000



Frequency/Period Counter Kit
Cat K-3439

\$89.95

Improve performance & increase range of Frequency Counter to 10-500 MHz

Get superb design at hobbyist's prices!

Superb design uses latest IC technology. Low component count makes it very reliable and easy to build. Measures frequencies to 50 MHz (up to 500 MHz with optional pre-scaler) and period exclusively with a 7 digit resolution. Supplied with the instructions and a quality pre-punched, silk-screened front panel and case.

Pre-Scaler Kit
Cat K-3439

\$22.50
Cat K-3432

Ask about our great Fun Way into Electronics books, kits & gift sets!

DESCRIPTION	CAT. NO.	PRICE	FEATURED IN:
Flashing Jewelry	K-2621	\$2.95	HO (1/86)
Canary Door Bell	K-2622	4.50	
Morse Practice Set	K-2623	5.50	HO (1/86)
Universal Timer	K-2624	4.95	
Universal Organ	K-2625	7.95	
LED Dice	K-2626	7.95	
Monophonic Radio	K-2627	5.50	HO (1/86)
Transistor Switch	K-2628	4.95	
Mosquito Repeller	K-2629	6.50	
Touch Amplifier	K-2630	5.50	
Basic Amplifier	K-2631	5.50	HO (1/86)
Wireless Microphone	K-2632	5.50	HO (1/86)
Light Activated Switch	K-2633	6.50	
Metal Pipe Locator	K-2634	4.95	
Sound Activated Switch	K-2635	8.95	
Home/Car Alarm	K-2636	8.95	HO (1/86)
Electronic Siren	K-2637	7.95	HO (1/86)
LED Level Display	K-2638	6.95	
Intercom	K-2639	9.95	
LED Counter Module	K-2640	19.95	
Shortwave Receiver	K-2661	9.95	
Auto Minder	K-2662	12.95	
Flip-A-Coin Gambler	K-2663	8.95	
Slot Machine	K-2664	12.95	
Build-A-Cricket!	K-2665	14.95	
Mini Color Organ	K-2666	19.95	
Light & Sound	K-2667	32.00	
Combined Timer Lock	K-2668	7.95	
Walkman Amplifier	K-2669	89.95	RE (3/86)
Binary Bingo	K-3428	22.50	RE (2/86)
Mini Synthesizer	K-3429	14.95	RE (8/86)
Infrared Transmitter	K-3439	14.95	RE (8/86)
Infrared Frequency Counter	K-3432	29.95	73 (8/86)
500 MHz Prescaler For Above	K-3440	19.95	73 (8/86)
Power Supply Kit For Above	K-3441	39.95	
60 Watt Mosfet Amp Module	K-3442	9.95	
120 Watt Mosfet Amp Module	K-3443	29.95	
20 Watt Amp Meter	K-3444	14.95	
LCD Panel Meter	K-3445	34.95	
3 Digit LCD Counter	K-3451	39.95	HO (11/86)
RLC Bridge	K-3468	11.95	
Audio Oscillator 15-150 KHz	K-3475	79.95	
1.3-30V Power Supply 0-1 Amp	K-3490	14.95	
Shortwave Antenna Kit	K-3500	149.00	RE (8-8/86)
Graphic Equalizer	K-3509	299.00	73 (8-8/86)
Ear Splitting Super Siren	K-3515	69.95	73 (8-8/86)
Sound Bender Generator	K-3516	169.00	73 (8-8/86)
200 W RMS Mosfet Stereo Amp	K-3520	159.00	Watch OST
Function Generator	K-6308	39.95	RE (11-12/86)
440 MHz Transceiver	K-6312	149.95	RE (4-5/86)
144 MHz SWR/PWR Meter	K-6314	139.00	STV (1/86)
VHF 100 Watt Linear Amp	K-6315	199.00	SR (1/86)
TV Captioning Decoder			
Teletext Decoder Kit			
Infrared Hi/Control For Above	K-3425	34.95	
Satellite Receiver Kit	K-6316	89.95	
Stereo Upgrade For Above	K-6317	29.95	
HF Transceiver	K-6320	229.00	73 (7/86)
Radio Direction Finder 50-500 MHz	K-6330	99.00	OST (8/86)
40 Meter Receiver	K-6345	29.95	73 (9/86)
Reinartz 2 Tube Radio			HO (Spring 85)
Unidyne 1 Tube Radio			HO (Fall '84)
Antique Crystal Radio			RE (10/86)
Dick Smith's Crystal Radio			
Mixer Preamp	K-9001	99.95	
4 Input Mixer Preamp	K-9002	79.95	
Ultra Fidelity Preamp	K-2692	14.95	
TV Scope Adapter Kit	K-3036	24.95	
Microwave Leakage Detector	K-3037	39.95	
4 Channel Color Organ	K-3052	14.95	
TV Masthead Preamp	K-3060	8.95	
LED Lamp Flasher	K-3095	99.95	
Car Alarm	K-3143	19.95	
Ultrasonic Movement Detector	K-3242	29.95	
Car Alarm	K-3245	9.95	
Negative Ion Generator	K-3250	9.95	
LED Level Meter	K-3251	19.95	
AM Stereo Decoder	K-3252	9.95	
Stereo Enhancer	K-3245	19.95	
Stereo Simulator	K-3251	24.95	
VCR Theft Alarm	K-3253	12.95	
4 Sector Purpose Alarm	K-3353	34.95	
General Purpose Preamp	K-3370	29.95	
	K-3415	49.95	
	K-3419	14.95	
	K-3421	39.95	
	K-3423	99.95	
	K-3424	4.95	
	K-3427		



ONLY \$599

Look at the savings this system offers!

XT Motherboard
BIOS for Motherboard
64K RAM
Monochrome Graphics
Floppy Disk Controller
130W Power Supply
IBM-style case
1/2 Height Disk Drive
Monochrome Monitor
84-key Keyboard

Individual Components Total \$668.95

X-1001 \$128.00
X-1000 \$99.95
X-1012 \$14.99
X-1017 \$39.95
X-1018 \$39.95
X-1019 \$39.95
X-1020 \$39.95
X-1100 \$39.95
X-1110 \$39.95
X-1120 \$59.95
X-1122 \$59.95

IBM PC/XT® Compatible Computer KIT

12 Month Warranty

Don't get lost in the Parking Lot!

Keypchain transmitter signals your car to beep its horn & flash its lights up to 750' away. Includes receiver & easy-to-use installation manual.

Car Finder \$99
Cat Y-3015

\$899
Cat Q-1243

NEW!

73 (7/86)
OST (8/86)
OST (9/86)
HO (Spring 85)
HO (Fall '84)
RE (10/86)

RE: Radio-Electronics
HO: Hands-On Electronics
ME: Modern Electronics
73: 73 for Radio Amateurs

SR: Satellite Retailer
STV: STV Magazine
OST: OST Magazine

And more kits are coming soon!

Watch our ads!

R-E Reader's Special

Take care of your computer!

This selection of Tech Spray computer care products is perfect for home or office computer maintenance! The kit includes: 3 oz. Precision Duster; 3 oz. Zero Charge Anti-Static Screen & Keyboard Cleaner; 3 oz. Zero Charge Anti Stat (for carpets & counter tops); 2 oz. Cabinet Cleaner; 12 Anti-Static Wipes; 12 Lint-Free Absorbent Wipes; 12 packets of Anti-Static Hand Lotion; 10 Anti-Static Swabs. Save money now and your computer later!

Techclean™ 19.95
COMPUTER CARE KIT Cat X-3520



was \$29.95

Attention Bulk Buyers!

Schools, Colleges
Manufacturers!
Call 415-368-8844
for special quantity pricing!



Visit our Retail Centers!

BERKELEY: 2474 Shattuck Ave (415)486-0755
REDWOOD CITY: 390 Convention Way (415)358-8844
SAN JOSE: 4980 Stevens Creek Blvd (408)241-2266
LOS ANGELES: 1830 Westwood Blvd (213)474-0526
HEAD OFFICE: 390 Convention Way Redwood City, CA 94063

NEW!
DSE Test Equipment



50 MHz Dual Trace Oscilloscope
SPECIFICATIONS: Vertical frequency & deflection: AC 10Hz/DC to 50 MHz; 5mV to 1mV/div on 10 ranges; 1-2.5 step (-3db); Rise time: 7.7n sec. • Overshoot: 3% • Modes: CH, A, CH-B, DUAL, ADD, X-Y • Input Impedance: 1M/20pF • 3pF • Max Input: 600V p-p or 300V DC or peak AC • Chop Frequency: 200KHz • Channel Separation: ±70dB of 1KHz • Time Base: Auto or triggered in Auto Mode Trace is on without input signal • Sweep Time: 0.2 sec to 0.5 sec/div on 20 ranges in 1-2.5 step, ±5 Mag • Triggering: Sensitivity Int. 1 div. or more • Ext. 1V p-p or more. Source Int CH 1, CH2 • Ext. Pos/Neg pull for Auto range • Calibration: 0.5V p-p ± 5% • Power: 120V ± 10% 50/60Hz.



\$529
Cat Q-1241
35 MHz Dual Trace Oscilloscope
Sweep Modes: 0.1 us-10 us/10 steps (Accuracy within ±3%)
Time Base: 10 ranges in 1-2.5 steps with time control
Sweep Magnifier: 5 times (5X MAG) (±10%)
Linearity: 3%
Delayed Trigger: INTEND: Delay time become dim
DELAY: 1/2000
Delayed: 100 msec-1 uses in 5 steps with variable
INT: More than 1 Div for DC-35 MHz (vertical PULL 5X GAIN)
More than 1 Div for DC-10MHz
More than 1 Div for DC-35MHz
EXT: Make the 0.2µV p-p LINE EXT.
10 EXT. TV LINE FRAME
Positive and negative, continuously variable with level control.
Slope: PULL AND FOR TRIGGER
Coupling: CH-A, Y axis; CH-B, X axis
XY Operator: Highest sensitivity: 1mV/Div

Signal or Audio Generator
Your choice only \$99.95 ea.

Wideband RF Signal Generator Cat Q-1312
Check & align IF circuits & tuners in AM/FM & TV. This low-cost RF signal generator does great general service, troubleshooting, and development work. Ideal for hobbyist, amateur & technician alike!
Specifications: 100kHz-1.5MHz in 6 overlapping ranges • ±1.5% accuracy • RF output: 100mV rms approx (up to 35MHz) • Modulation: 1kHz internal; 50Hz-20kHz external • Audio output: 1 kHz at 1V rms (fixed) • Crystal oscillator: 1-15MHz ext. crystal, FT 243 holder • 110V AC

AF Signal Generator Cat Q-1310
Get square/sine wave output essential for work on a huge range of circuits. This audio signal generator has wide output & high accuracy. It's the perfect partner for the RF generator above.
Specifications: 20Hz-200KHz • 3% -2Hz accuracy • 600ohms unbalanced output impedance • Square wave: 20Hz, 10V p-p max. 0.5 us rise time • Sine wave: 20KHz-20KHz, 5V rms max. 1% or less distortion • Synch: ± 3% of osc. freq. V rms



Get a personal copier that's always there when you need it!

NEW!

A hand-held, cordless copy machine - Copy Jack is less than 7" long and ready to copy from the moment you turn it on. Pass the reading head over your original and the CCD scanner reads & reproduces line art (not recommended for photos) as a 198 dots/inch image on thermal paper. No toner or maintenance! Uses 13.2V DC Ni-Cad battery. Includes Ni-Cad charger & cord.

COPY JACK™ \$299
Cat Y-9510
Copy Jack Paper \$12 Cat Y-9511
Box of 5 rolls



MAIL ORDER INFORMATION
DSE, P.O. Box 8021, Redwood City, CA 94063
14 Day Money-Back Guarantee
We ship UPS Ground unless otherwise requested. Add 5% of order total (\$1.50 min.) for shipping. Outside USA add 20% (\$4 min.). There is an additional \$1.50 handling fee. California residents please add sales tax.

ORDER TOLL FREE!
1-800-332-5373
Call Mon-Fri 10am-6pm Pacific time.
In California call 415-368-1066

DICK SMITH ELECTRONICS
Do you have our FREE CATALOG?
It's 148 colorful pages packed with thousands of fantastic products, incredible values, and an exclusive 15-page Data Section. We ship our catalogs first class mail, so send the coupon below and get yours without delay!

YES! I want my copy of the Dick Smith Electronics 1986/87 Catalog. Enclosed is \$1.00 for postage & handling.

Name _____ Address _____ City _____ State _____ Zip _____

Are you on our mailing list? Send for your FREE CATALOG (see coupon at right) and receive our seasonal & special mailers, too!

TENMA

© 1986, MCM Electronics

TENMA Combination Function Generator and Frequency Counter

- Six digit display ■ Output range: .2Hz-2MHz: seven ranges ■ Counter range: .1Hz-10MHz ■ 5-15V TTL and CMOS output
- Wave forms: sine, triangle, square, pulse, and ramp. For detailed specifications call for a complete Tenma catalog.

#72-380

\$21990
(ea.)

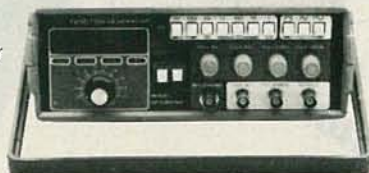

THE NAME YOU CAN TRUST IN ELECTRONIC TEST EQUIPMENT

TENMA Combination DMM/ Capacitance Meter

- Measures voltage, AC and DC current up to 10A
- Resistance up to 20Mohm
- Capacitance up to 20µF
- Built-in transistor tester
- Test leads and carrying case included ■ For detailed specifications call for a complete Tenma Catalog

#72-045

\$7495
(ea.)

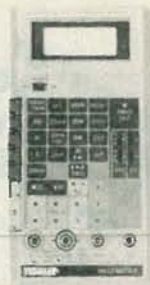

TENMA 120MHz Frequency Counter

- Eight digit LED display ■ Measurement range: .1Hz-120MHz ■ High input sensitivity of 20mV RMS. For detailed specifications call for a complete Tenma catalog.

#72-375

\$18995
(ea.)



TENMA 30A Power Supply

- Output voltage: 1-15VDC ■ Lighted cross needle meter: Displays voltage, current and power simultaneously ■ Output current: 30A, 24A continuous ■ Fan cooled

#72-035

\$22780
(ea.)

TENMA Digital LCR Meter

- Measures inductance, capacitance and resistance ■ L = 1µH-200H, C = .1pF-200µF, R = .01ohm-20Mohm
- Carrying case included. For detailed specifications call for a complete Tenma catalog.

#72-370

\$14995
(ea.)



TENMA Clamp-On/DMM

- Measures AC current via clamp ■ High quality built-in DMM measures DC volts, AC volts, resistance, AC current ■ Peak hold
- Data hold ■ Audible continuity buzzer ■ Test leads and carrying case included. For detailed specifications call for a complete Tenma catalog.

#72-395

\$8490
(ea.)

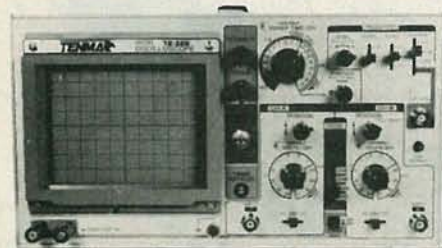

TENMA 20MHz Dual Trace Oscilloscope

- Two high quality 10:1 probes included. For detailed specifications call for a complete Tenma catalog.



#72-320

~~\$38995~~

SPECIAL!

\$34995
(ea.)



TENMA 4 1/2" Digit Multimeter

- True RMS AC voltage and current functions ■ Built-in frequency counter, 20KHz and 200KHz range ■ Data hold feature ■ Measures AC and DC voltage/current, resistance and frequency ■ Carrying case included.

#72-430

\$15980
(ea.)



Be Sure To Call For Your FREE Catalog! Over 6,000 Items!

We also have ... a full line of test equipment, computer accessories, telephone accessories, speakers, television parts, flybacks, yokes, switches, fuses, lamps, capacitors, resistors, cartridges, styli, wire, CATV equipment, the largest selection of original Japanese semiconductors in the country and more.



Terms:

- \$10 minimum order. \$1.00 charge for orders under \$10.
- \$20 minimum charge card order.
- Orders shipped UPS C.O.D.
- Most orders shipped within 24 hours.
- Sales office open 8:30 am to 7:00 pm Saturdays 10:00 am to 3 pm EST.
- For prepaid orders add \$2.75 for shipping and handling.
- Should shipping and handling charges exceed \$2.75, the balance due will be sent C.O.D.



858 E. CONGRESS PARK DR. • CENTERVILLE, OH 45459
(513) 434-0031



MCM ELECTRONICS

A PREMIER Company

SOURCE NO. RE-27

CALL TOLL FREE 1-800-543-4330

In Ohio 1-800-762-4315 • In Alaska and Hawaii 1-800-858-1849

CIRCLE 87 ON FREE INFORMATION CARD

BUILDING A ROBOT?

MOTION PACKAGE
DIRECT GEAR DRIVE FOR
WHEELS 12 INCH OR LARGER

ONLY 99⁰⁰

INCLUDES:
2ER DC MOTORS
2ER 16:1 GEARBOXES
2ER 24 TOOTH STEEL SPUR GEARS
2ER 60 TOOTH NYLON IDLE GEARS
2ER 235 TOOTH 12 INCH DRIVE GEARS

MOTOR, GEARBOX, & IDLE GEAR ARE PRE-ASSEMBLED. DRIVE GEAR IS READY TO MOUNT ON YOUR WHEEL.

VDC	RPM	NO LOAD	STALL	MPH	PARTIAL DATA LISTING SEND FOR COMPLETE LISTING
24	34	800 MA	10.0 AMP	1.25	
18	27	600 MA	7.5 AMP	.96	
12	18	500 MA	5.0 AMP	.64	
6	8	450 MA	2.5 AMP	.21	

SEND POSTCARD FOR COMPLETE LIST OF ROBOTICS PARTS

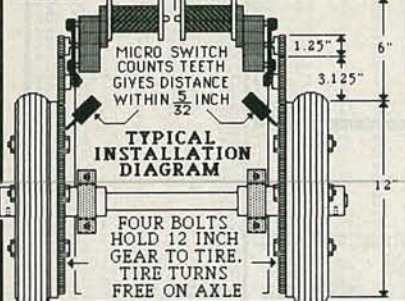

TERMS: COD OR PREPRID ONLY PREPRID: ALLOW 2 WEEKS FOR CHECK TO CLEAR. COD-CASH OR CERTIFIED CHECK ONLY. ADD \$1.90 OFFER GOOD WHILE SUPPLIES LAST. STORE PRICE MAY DIFFER. PRICES MAY CHANGE.

Silicon Valley Surplus
415-261-4662
10AM-6PM CLOSED SUN & MON

4401 OAKPORT OAKLAND, CA. 94601
415-261-4662
HIGH ST. & 880

CIRCLE 190 ON FREE INFORMATION CARD

ADVERTISING INDEX

RADIO-ELECTRONICS does not assume any responsibility for errors that may appear in the index below.

Free Information Number	Page	61	Microprocessors Unltd.	C16	
—	"2001"	CV3	117	Mouser	90
81	A.I.S. Satellite	77	—	NRI	26
108	AMC Sales	90	191	NTS	76
76	AP Products Brand of 3M	22	201	Nivie	96
107	All Electronics	97	205	NuScope Associates	CD16
183	Allen Systems	88	—	Oak Systems Sales	91
—	Amazing Devices	112	110	Omnitron	24
84	Appliance Service	76	—	OrCad Systems	88
194	BV Engineering	88	—	Pacific Cable	93
77	B&K Precision	19	199	RCA D&SP	33
182	Banner Technical Books	35	78	Radio Shack	103
98	Beckman Industrial	75	70	Ramsey	85
85	Blue Star Industries	77	179	Regency	36
109	C & S Sales	73	97	Saratoga Electronics	95
—	C.O.M.B.	83	177,178	Sencore	22,25
60	CIE	8	190	Silicon Valley Surplus	112
204	Cable Distributors	77	94	Star Circuits	77
200	Cabletronics	76	92	Tektronix	CV2
188	Caig Laboratories	32	192	Test Ware	76
—	Command Productions	89	196	Trans-Am	96
79,176	Communications Electronics	3,17	102	Trio-Kenwood	87
197	Cook's Institute	91	180	United Electronic Supply	20
—	Coop's Satellite Digest	6	203	United Imports	77
125	Copper Electronics	32	66	W.S. Jenks	78
202	Crosley	7	103	Wm B Allen	5
127	Deco Industries	76,77			
95	Dick Smith Electronics	108,109			
82	Digi-Key	111			
198	ESI	34			
206	Electrical Publishing	CD16			
—	Electronics Book Club	79			
—	Electronic Technology Today	CD9			
120	Elephant Electronics	77			
111	Etronix	24			
100	Firestik II	89			
—	Fischertechnik	81			
121	Fluke Manufacturing	30			
—	Fordham Radio	CV4			
—	GRE America	35			
—	Grantham College of Engineering	31			
—	Halix Institute	84			
62	Hameg	70			
181,86	Heath	7,45-47			
—	ICS Computer Training	91			
—	ISCET	84			
65	J&W	106			
59	JDR Instruments	21			
113,184	JDR Microdevices	98,99			
185,186	JDR Microdevices	100,101			
187	JDR Microdevices	102			
114	Jameco	104,105			
115	Jensen Tools	77			
—	Joseph Electronics	13			
195	Leader Instruments	15			
87	MCM Electronics	110			
93	Mark V. Electronics	107			

Gernsback Publications, Inc.
500-B Bi-County Blvd.
Farmingdale, NY 11735
(516) 293-3000
President: Larry Steckler
Vice President: Cathy Steckler

For Advertising ONLY 516-293-3000
Larry Steckler
publisher
Arline Fishman
advertising director
Shelli Weinman
advertising associate
Lisa Strassman
credit manager
Christina Estrada
advertising assistant

SALES OFFICES

EAST/SOUTHEAST
Stanley Levitan
Eastern Sales Manager
Radio-Electronics
259-23 57th Avenue
Little Neck, NY 11362
718-428-6037, 516-293-3000

MIDWEST/Texas/Arkansas/Okla.
Ralph Bergen
Midwest Sales Manager
Radio-Electronics
540 Frontage Road—Suite 339
Northfield, IL 60093
312-446-1444

PACIFIC COAST/ Mountain States
Marvin Green
Pacific Sales Manager
Radio-Electronics
15335 Morrison St.—Suite 227
Sherman Oaks, CA 91403
818-986-2001

AMAZING DEVICES

PHASORS
PLANS—All Parts Available in Stock
• LC5 BURNING CUTTING CO2 LASER ... \$20.00
• RUB3 RUBY LASER RAY PISTOL ... 20.00
• BTC5 1.5 MILLION VOLT TESLA COIL ... 15.00
• PTG1 PLASMA TORNADO GENERATOR 10.00
• GRA1—GRAVITY GENERATOR ... 10.00
• MAGNETIC CANNON PROJECTOR ... 10.00

LASERS
KITS—Includes Plans and Parts
• LHC2K SIMULATED RED/GRN/YEL LIGHT LASER ... 34.50
• BTC3K 250,000 VOLT TESLA COIL ... 159.50
• 10G1K ION RAY GUN ... 109.50
• PSP3K PHASOR SHOCK WAVE PISTOL 49.50
• STG1K—STUN/PARALYZING GUN ... 39.50
• INF1K INFINITY TRANSMITTER ... 134.50
• MFT1K 2-3 MILE RANGE FM VOICE XMTR PC BOARD ... 49.50

SECURITY
ASSEMBLED AND TESTED PRODUCTS
• LGU30 RED 1MW PORTABLE HENE LASER ... 349.50
• TCL30 SOLID STATE TESLA COIL 35KV 84.50
• IPG50 POCKET PAIN FIELD GENERATOR 64.50
• BLS10 BLASTER DEFENSE WEAPON ... 89.50
• ITM10—100KV SHOCK AND STUN GUN 99.50
• PPF10 PHASOR PAIN FIELD PORTABLE 249.50
• SNP20 SECURITY PHONE LISTENER ... 99.50

• CATALOG CONTAINING DESCRIPTIONS OF ABOVE PLUS HUNDREDS MORE AVAILABLE FOR \$1.00 OR INCLUDED FREE WITH ALL ABOVE ORDERS.

PLEASE INCLUDE \$3.00 PH ON ALL KITS AND PRODUCTS. PLANS ARE POSTAGE PAID. SEND CHECK. MO, VISA, MC TO:

INFORMATION UNLIMITED
P.O. BOX 716, DEPT. N1 AMHERST, NH 03031

2001 IS COMING IN MAY



An electronics revolution is in the making, but you don't have to wait until 2001 to find out how it will change your life in the 21st century. Radio-Electronics will forecast the coming changes and how they will affect you in the May 1987 issue!

Created by a special editorial task force—two years in preparation—this unique issue, 2001, takes you into the research laboratories of Westinghouse, Texas Instruments, Ford and Bell Labs where the future is being invented today!

You'll get an advance look at what's coming in artificial intelligence... new cars and highways (cleaner, quieter and more efficient)... futuristic energy sources like magneto-hydrodynamic and particle-beam generators... personal communications systems that will give you instant access to anyone anywhere... super computers and teaching breakthroughs that will multiply your capacity to learn!

Arthur Clarke introduces 2001. Isaac Asimov explores the marvels of robotics. But it is not science fiction. Rather it is

emerging technology with a solid foundation in current research and development.

And its impact will be enormous. It will change the way you work...the way you think...the way you live!

2001 is the kind of special publishing event that can only happen once in any magazine's lifetime and it will happen to Radio-Electronics in May, 1987.

With extra features and extra pages, 2001 will bear a premium cover cost, but you can reserve your copy now at less than the regular cover cost by mailing any one of the subscription orders in this issue.

2001 is coming in May. Make sure now that you don't miss it!

Radio-Electronics[®]

SCOPE 3 1/2 Digital Multimeters



Model DVM-638
\$7995

- Test leads included
- 11 function, 38 ranges
- Logic level detector
- Audible visual continuity
- Capacitance and conductance measurement

Model DVM-634
\$4875

- 7 function, 32 ranges
- Transistor measurement

Model DVM-636
\$6275

- 8 function, 37 ranges
- Capacitance measurement

SCOPE 3 1/2 Digit Capacitance Meter



Model DCM-602
\$6995

- Test leads included
- 8 ranges with full scale values to 2000 uF
- LSI circuit
- Crystal time base
- Frequency range 800 Hz to 8Hz

SCOPE Pocket Sized Audio Signal Generator



Model RC-555
\$6995

- Test leads & 9V battery included
- Low distortion sine-wave signal
- 46 step selected frequency
- x1 range 20 Hz to 1.5 KHz
- x100 range 2 KHz to 150 KHz

SCOPE 4 1/2 Digit LCD Bench Digital Multimeter

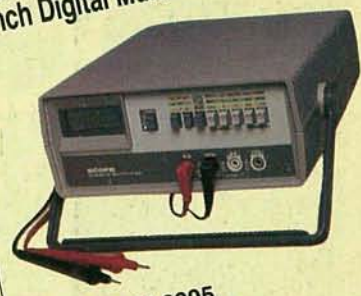

Model DVM-6005
\$19995

- Test lead set 6, "D" size batteries included
- 0.4" high characters
- Conversion period: 500 milliseconds
- Automatic, negative polarity

Mini-Meters with Maxi-Specs

SCOPE 3 1/2 Digit LCD with 8 Full Functions

Model DVM-632

\$4495
OUR PRICE

Measures only 5 3/8" x 2 3/16" x 1 1/4"

- Deluxe test leads included
- 0.5% accuracy
- Transistor gain test
- Audible continuity checking & diode test
- 10 Amp measurement

Zipped Carrying Case CC-30 **\$450**



SCOPE 3 1/2 Digit LCD



Measures only 5" x 2 3/4" x 7/8"

Model DVM-630

\$2995

- OUR PRICE
- Test leads included
 - 0.5% accuracy
 - 6 functions, 19 ranges
 - Automatic zero adjust
 - Low battery indication

Zipped Carrying Case CC-30 **\$450**

ASK FOR FREE CATALOG. Money orders, checks accepted. C.O.D.'s require 25% deposit.



Service & Shipping Charge Schedule Continental U.S.A.

FOR ORDERS	ADD
\$25-\$100	\$4.50
\$101-\$250	\$6.00
\$251-500	\$8.00
\$501-750	\$10.50
\$751-1,000	\$12.50
\$1,001-1,500	\$16.50
\$1,501-2,000	\$20.00
\$2,001 and Up	\$25.00

Fordham
260 Motor Parkway, Hauppauge, NY 11788

Toll Free **800-645-9518**
In NY State **800-832-1446**